

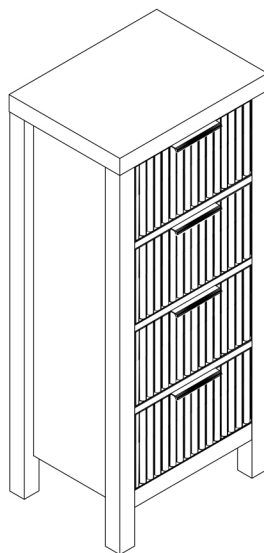

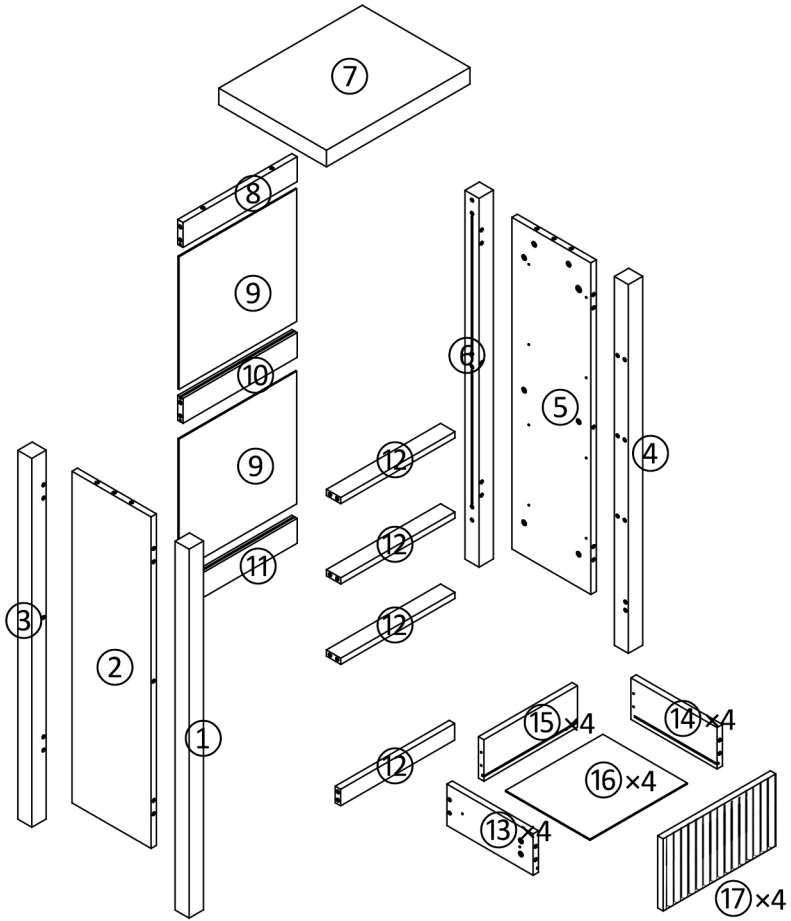











# ASSEMBLY INSTRUCTION

- Read the assembly instructions carefully before beginning assembly.
- Ensure the safety of the glass during assembly.
- Do not over tighten the screws and bolts as this may damage the threads.
- Insert the screw into the hole as shown in the figure, follow the arrow in the picture, and then rotate 90° or 180° clockwise.
- Keep the small accessories in the accessory bag away from children.
- The remaining parts are spare parts.
- Kind tips: when installing the white backboard, install the white side inward.
- The operating instruction of RGB light is included in the package. Read it carefully when assembling .





<b>A</b>  54pcs	<b>B</b>  54pcs	<b>C</b>  3.5*14 40pcs	<b>C8</b>  3.5*12 8pcs	<b>C9</b>  4*30 16pcs	<b>E</b>  8*40 18pcs	<b>F</b>  4pcs	<b>K</b>  8pcs	<b>X</b>  2pcs	<b>Y</b>  8pcs
<b>AG</b>  1pcs	<b>AM</b>  Decorative paper 18pcs	<b>AP</b>  anti-slip stickers 4pcs							



# WARNING

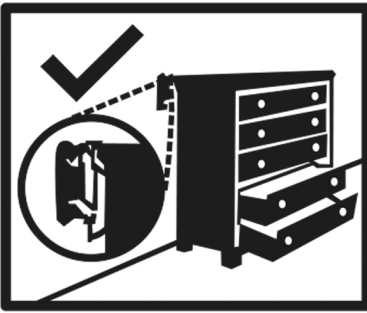
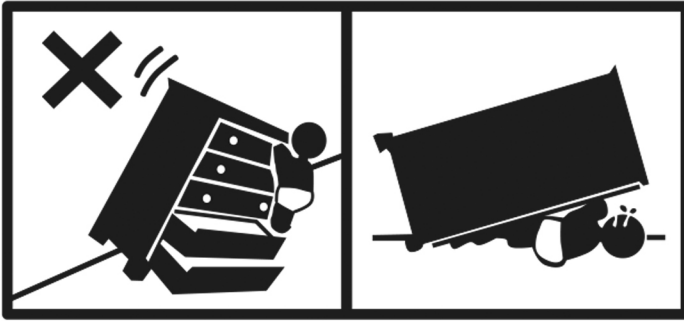

Children have died from furniture tip over. To reduce the risk of tip over:

- ALWAYS secure this furniture to the wall using an anti-tip device.
- NEVER allow children to stand, climb, or hang on drawers, doors or shelves.

Do not defeat or remove the drawer interlock system.

Place heaviest items in the lowest drawers.

NEVER put a TV on this furniture.



# Hardware installation demonstration

● Please make sure "A" hardware tightened and can't be pulled out

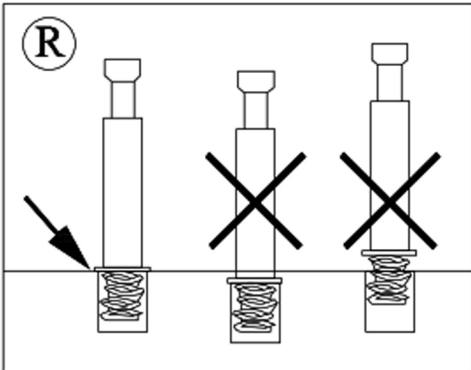
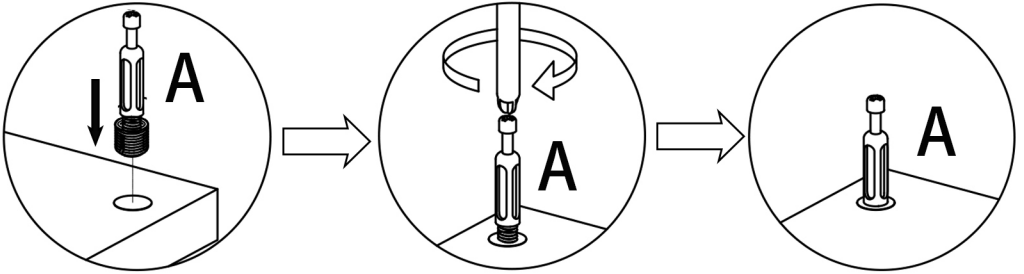



## Hardware installation demonstration

- When inserting cam ensure arrowhead on cam points toward the hole on the panel edge

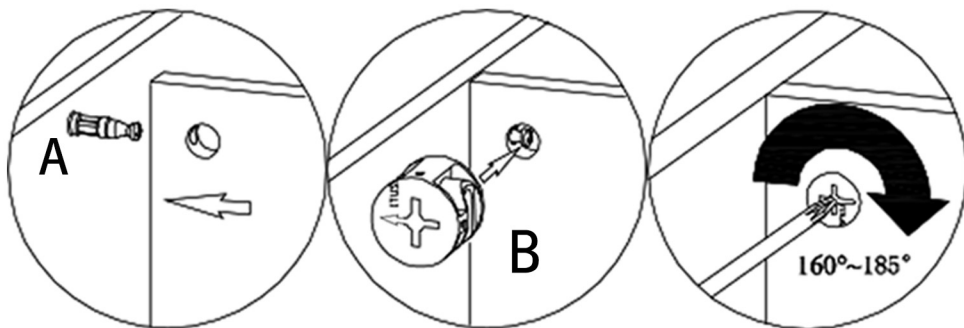



## Hardware installation demonstration

- Before installing the drawer rail, you need to separate the K1 and K2 first.

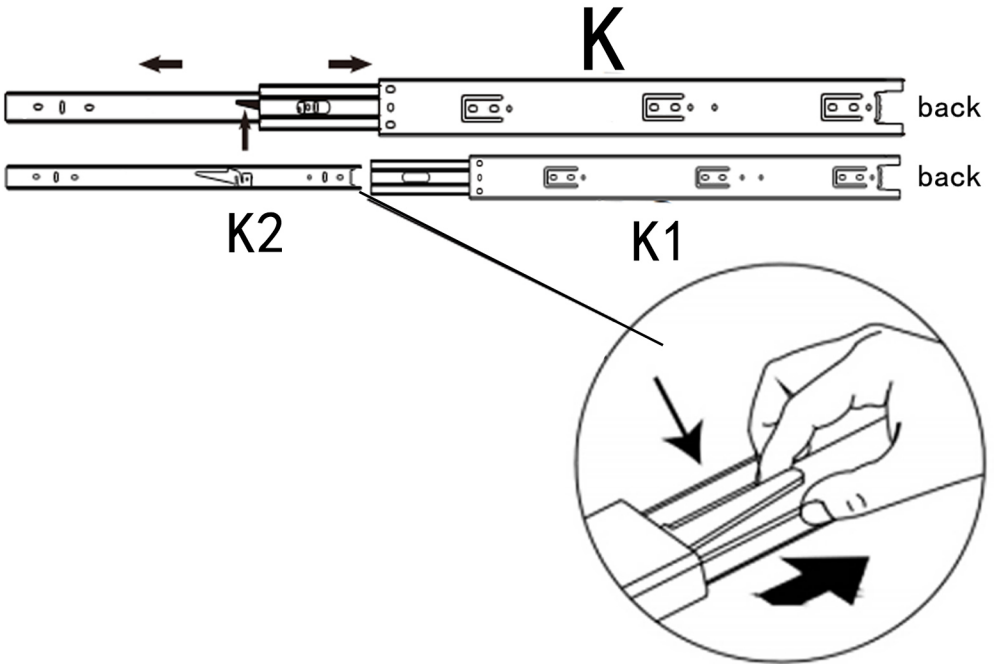

Warm Reminder: Press it and split



# Hardware installation demonstration



The first screw hole should corresponded with the board location hole

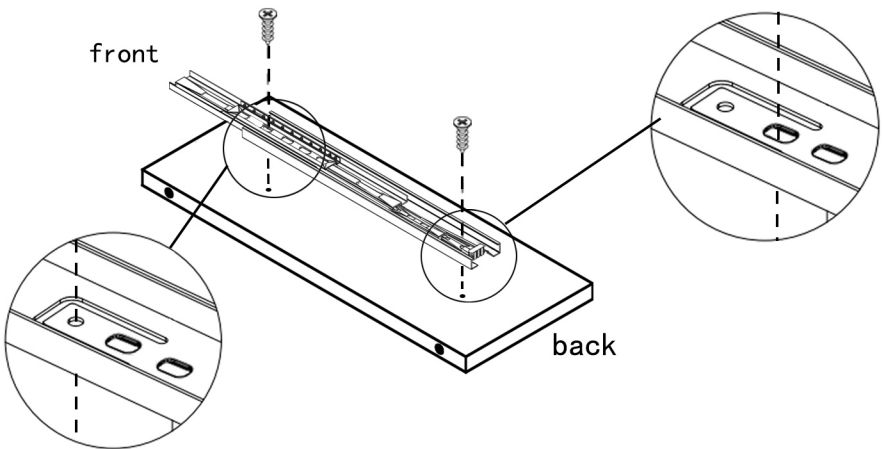

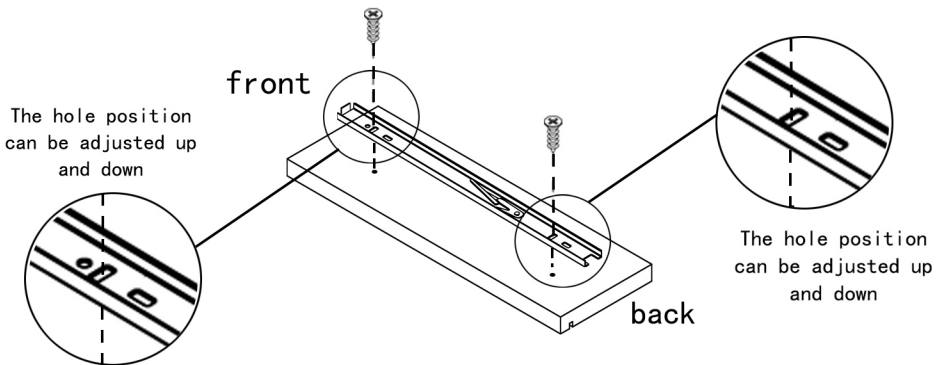

The first screw hole should corresponded with the board location hole



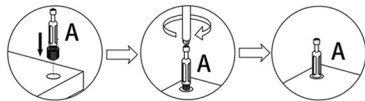
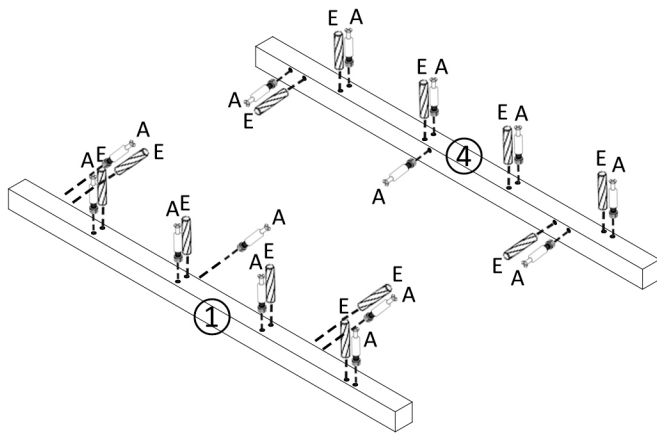

# STEP 1

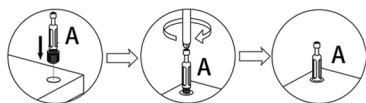
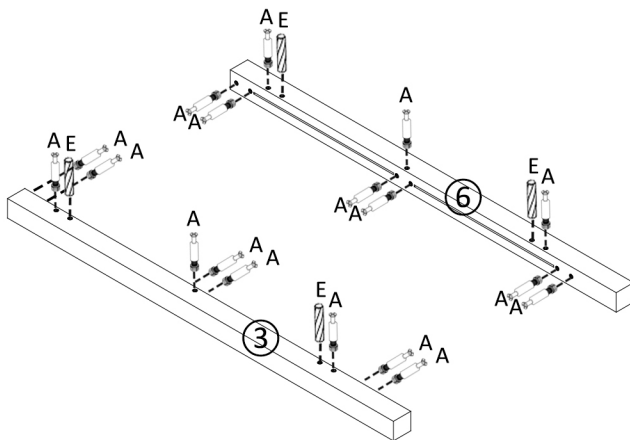

	E*12
	A*14

# STEP 2



	E*4
	A*18

# STEP 3

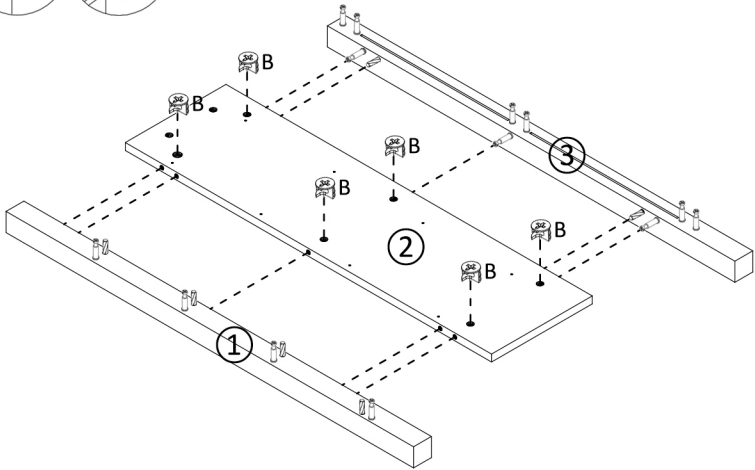
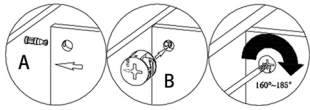

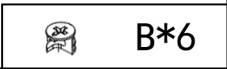
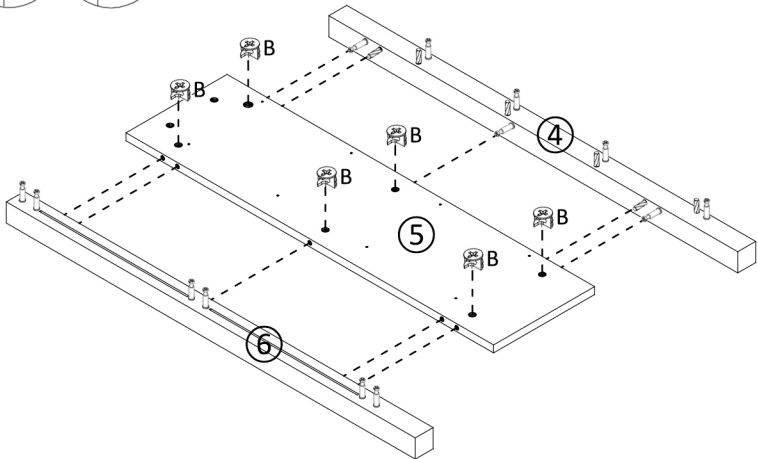
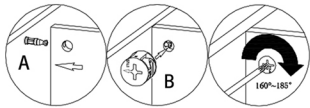

# STEP 4



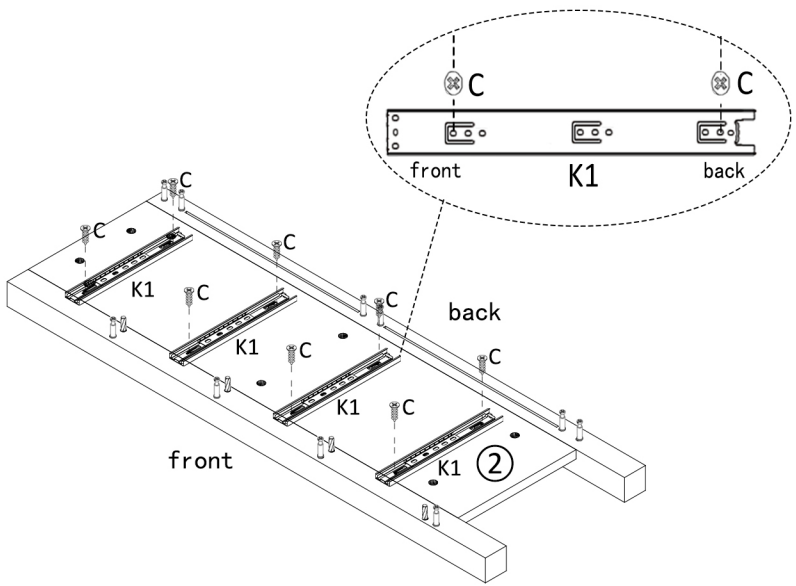

# STEP 5

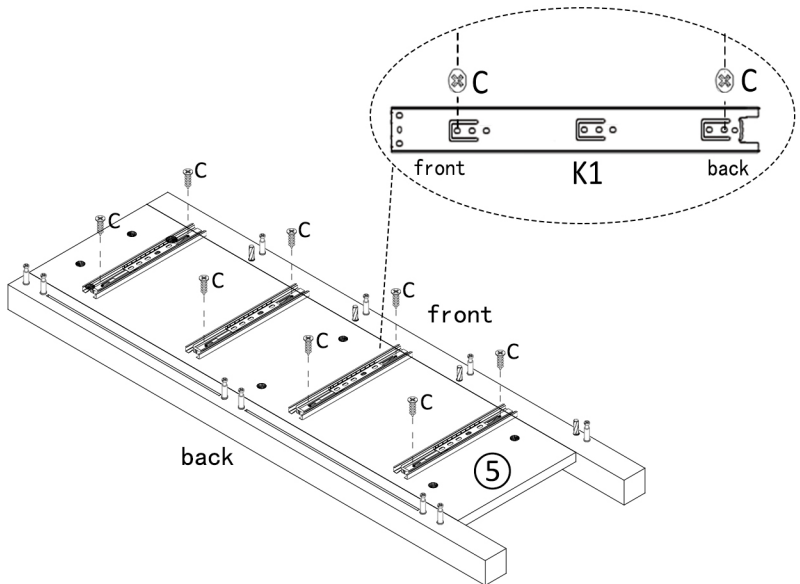

 3.5*14	<b>C*8</b>
	<b>K1*4</b>

# STEP 6



 3.5*14	<b>C*8</b>
	<b>K1*4</b>

# STEP 7

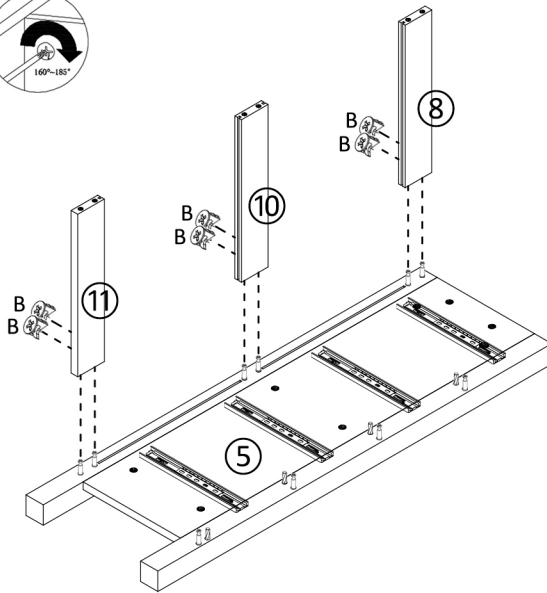
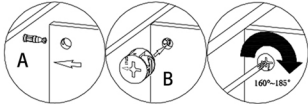

B\*6

# STEP 8

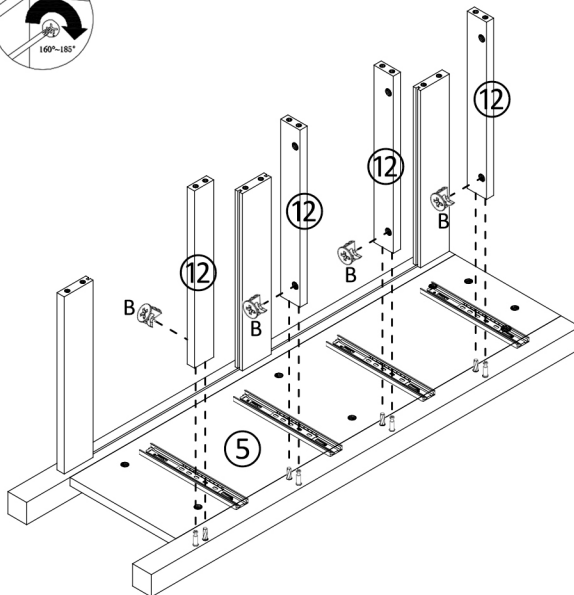
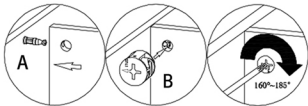

B\*4

# STEP 9

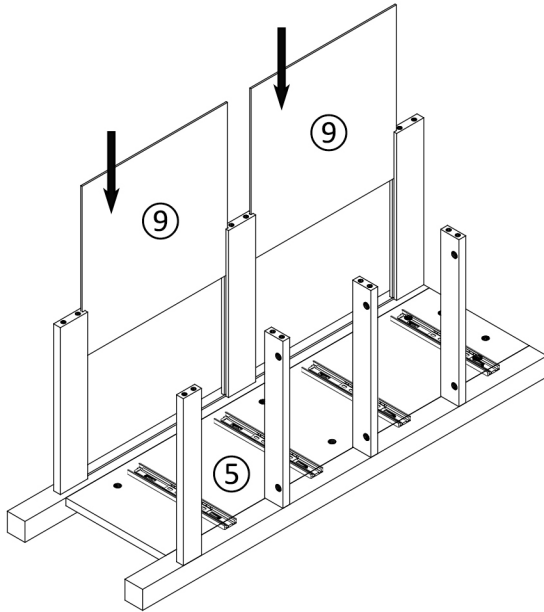

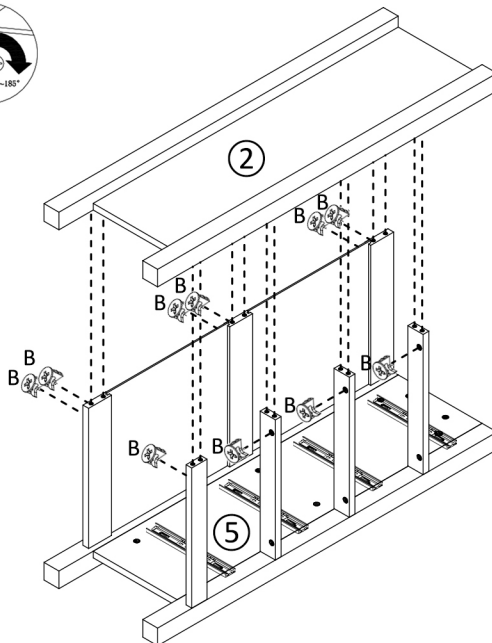
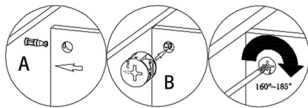

# STEP 10

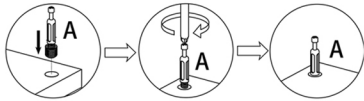
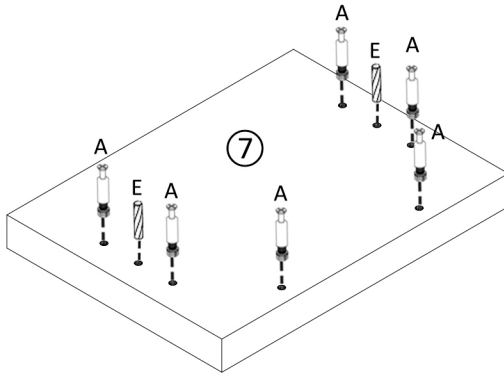

B\*10

# STEP 11



	E*2
	A*6

# STEP 12

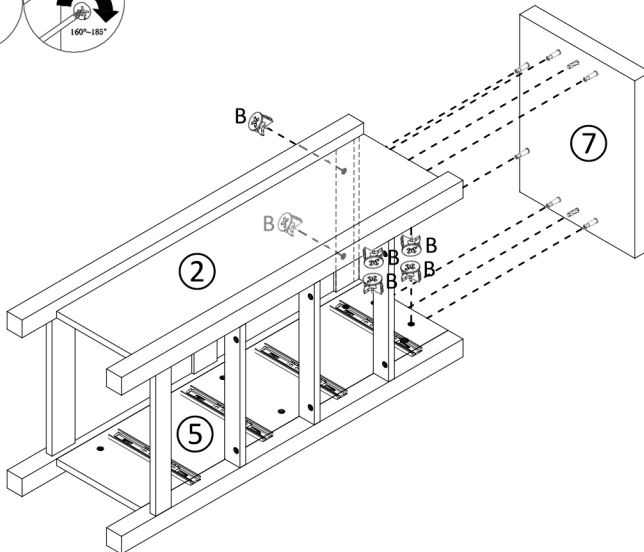
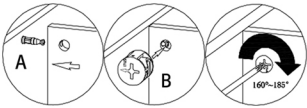

	B*6
---	-----

# STEP 13

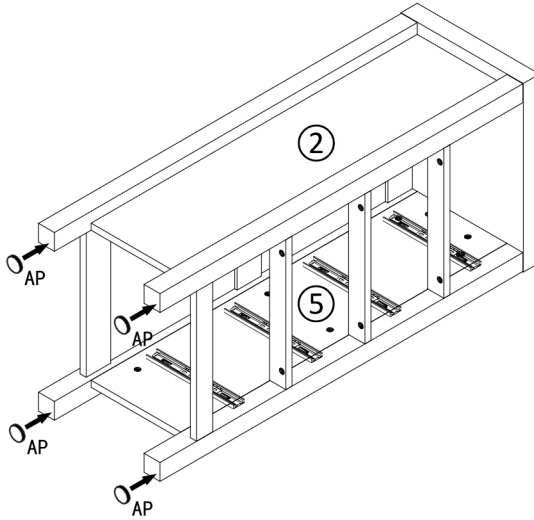
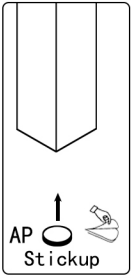

# STEP 14

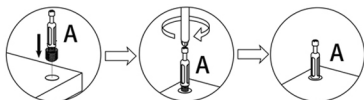
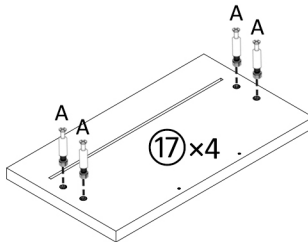

# STEP 15

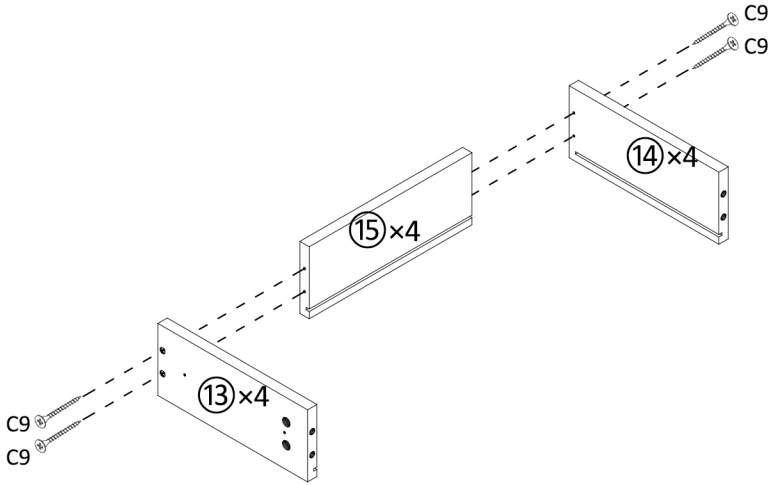

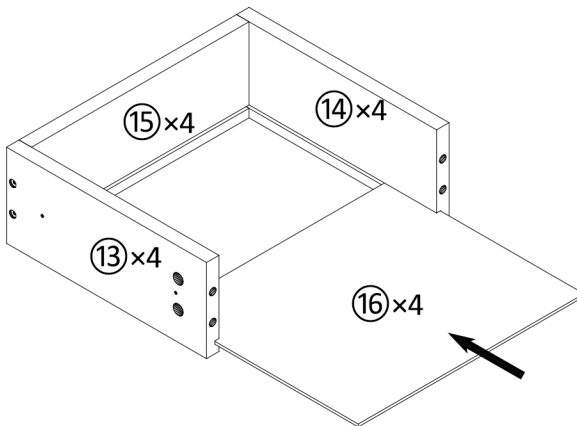

# STEP 16

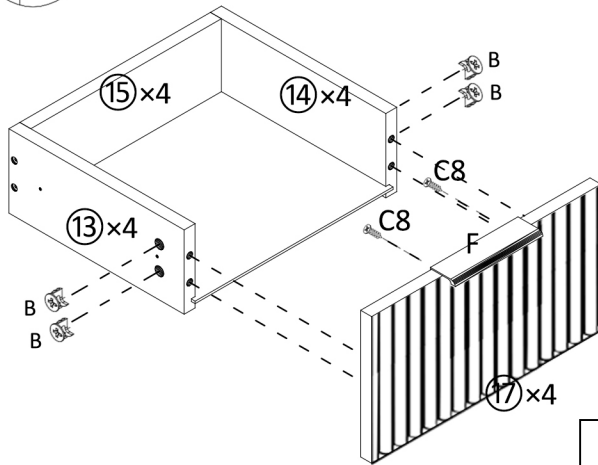
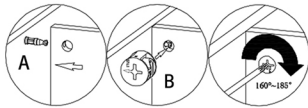

# STEP 17





 3.5*12	<b>C8*8</b>
	<b>F*4</b>
	<b>B*16</b>

⚠ Please use screws according to the specific size, do not confuse them.

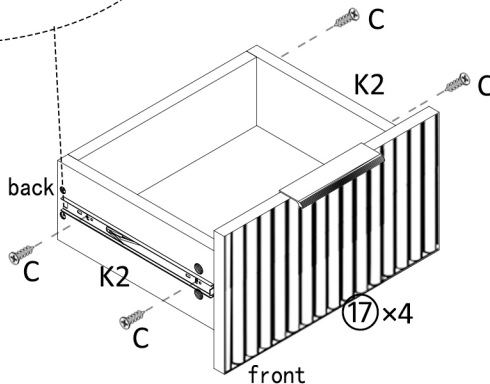
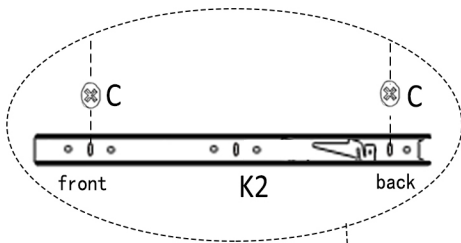
# STEP 18



 3.5*14	<b>C*16</b>
	<b>K2*8</b>

# STEP 19

Note: When assembling the inner slide rail, it is necessary to place the inner slide rail on the steel ball component first, and push the inner rail parallel to the outer rail together. Direct violence will lead to the falling off or deformation of the rail steel ball.

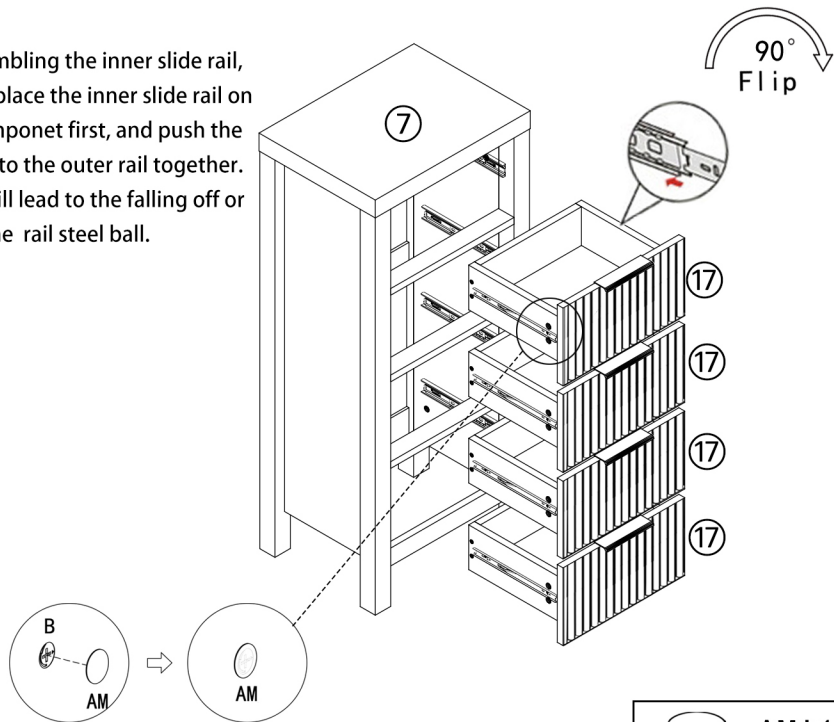

 **AM\*18**  
Decorative paper

# STEP 20

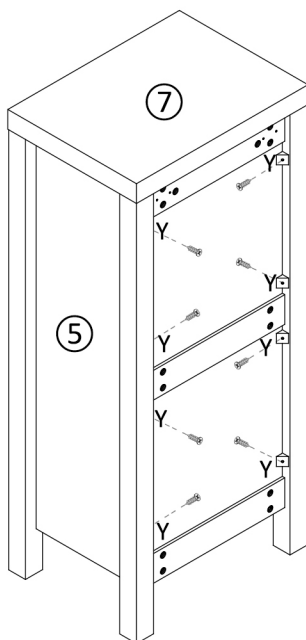
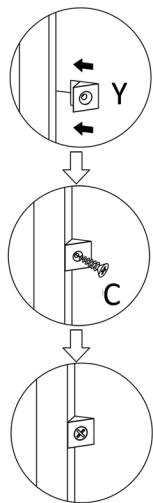

 **C\*8**  
3.5\*14



 **Y\*8**

Use tools to install if necessary

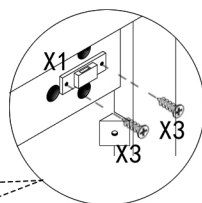
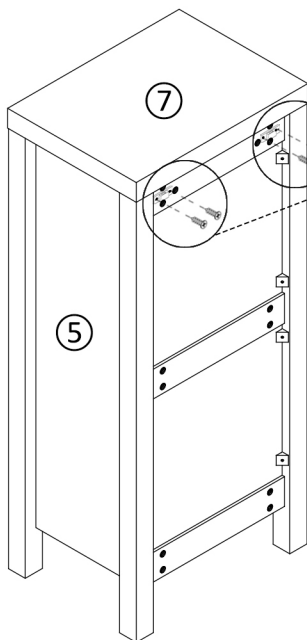
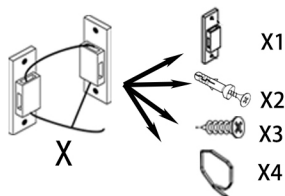
# STEP 21



Please separate the parts in bag No.X according to the picture and mark them as X1, X2, X3, and X4.

	X3*4
	X1*2

# STEP 22

1. One side of the anti-toppling safety belt is installed on the cabinet body
2. The other side of the anti-toppling safety belt is mounted on the wall
3. The seat belt is fastened through both safety buckles and then tightened

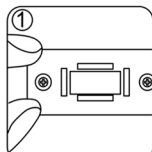
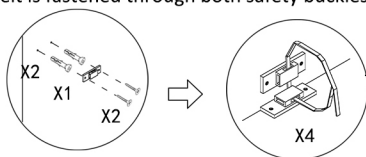

1. make mark on the wall

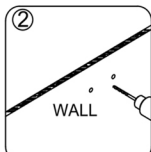

2. drill two Ø6 holes on the wall

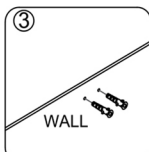

3. put two anchors in the holes

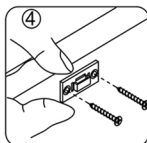

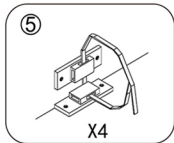

4. fix the device (X1) on the wall by the long screws (X2)

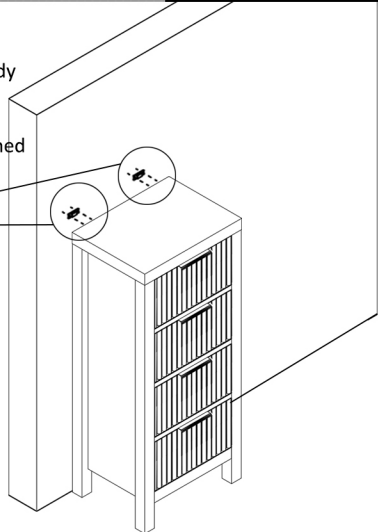

5. Push the cabinet close to the wall so that the two bases are close to each other, and then put on belt (X4) to tighten it.



	X1*2
	X4*2
	X2*4