









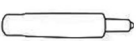
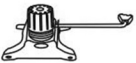

# Assembly Instruction

## NOTE

1. Plz Check all accessories before assembly!
2. Please **keep the original packaging** until you are sure satisfied with it. 😊
3. Any questions, Contact **customer-service**

(1)		x5
(2)	1 	x1
	2 	x5
(3)		x1
(4)		x1
(5)		x2
(6)		x1
(7)		x1
(8)	1  M6*12mm	x10
	2  M6*20mm	x4
	3  M6*30mm	x8
	4  Small caps for Armrests	x8
	5  M6	x1

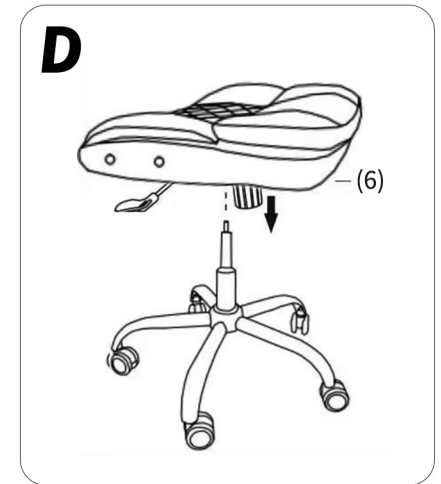
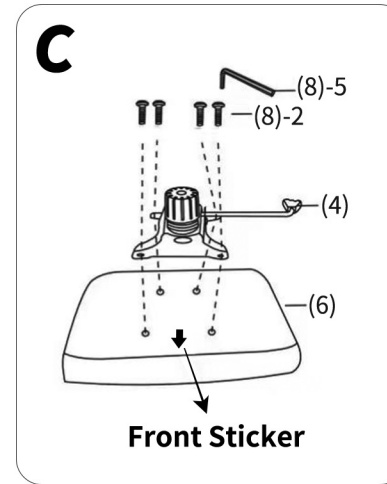
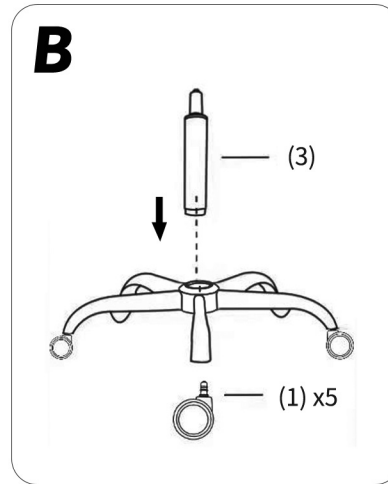
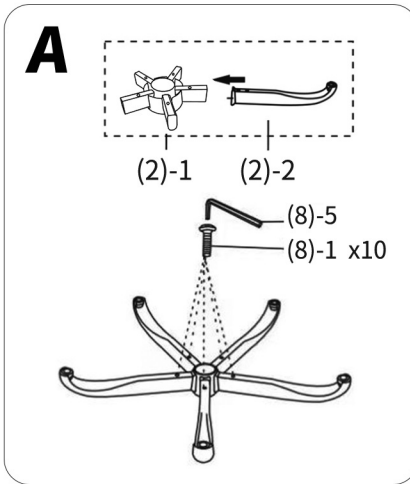

When assembling, each screw only needs to be tightened by 70%, and after all are in place, they can be tightened 100% one by one.

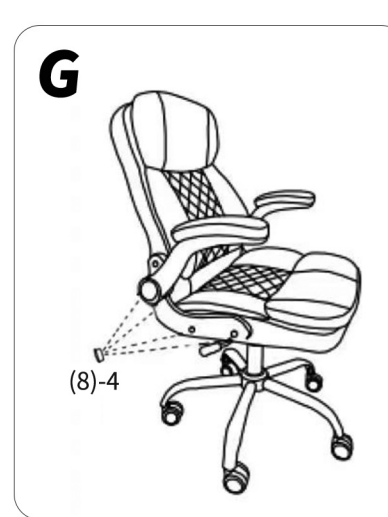
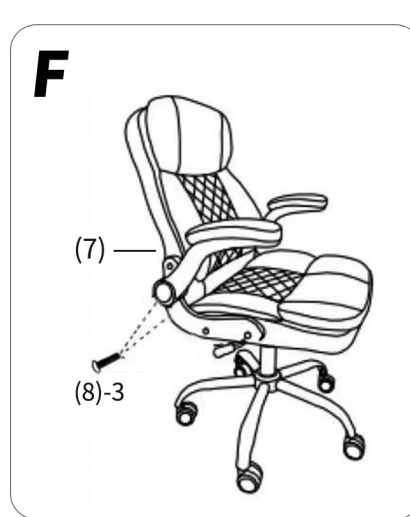
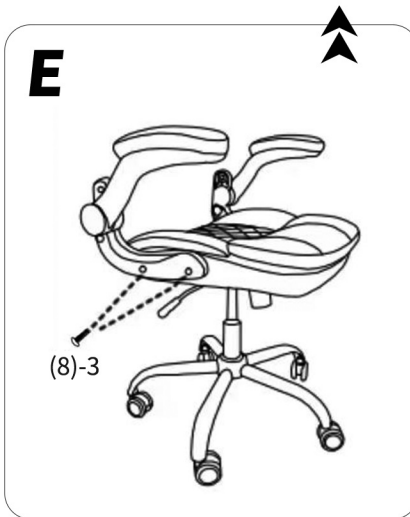

When the chair is fully assembled, make sure the **handle is on the right side** of the chair when you sit down. ▼