







## ASSEMBLY INSTRUCTION CHAIR

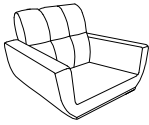
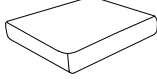

Legs & hardware are stored under the seat cushion, please take out the legs and hardware for assembly.

**Note:** Do not use power tools for assembly. Power tools increase the risk of over tightening which lead to splitting or cracking the wood.

### Component list

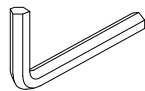
No	Drawing	Qty	Description
A		1	Chair
B		1	Seat cushion
C		1	Pillow
D		4	Wooden legs (Ø40*Ø35*148mm)
E		12	Bolt (1/4*25mm)
F		1	Allen key (M4*59mm)

**THE PARTS ARE LOCATED INSIDE THE BOX AS BELOW:**

**WOODEN LEGS**

**HARDWARE**

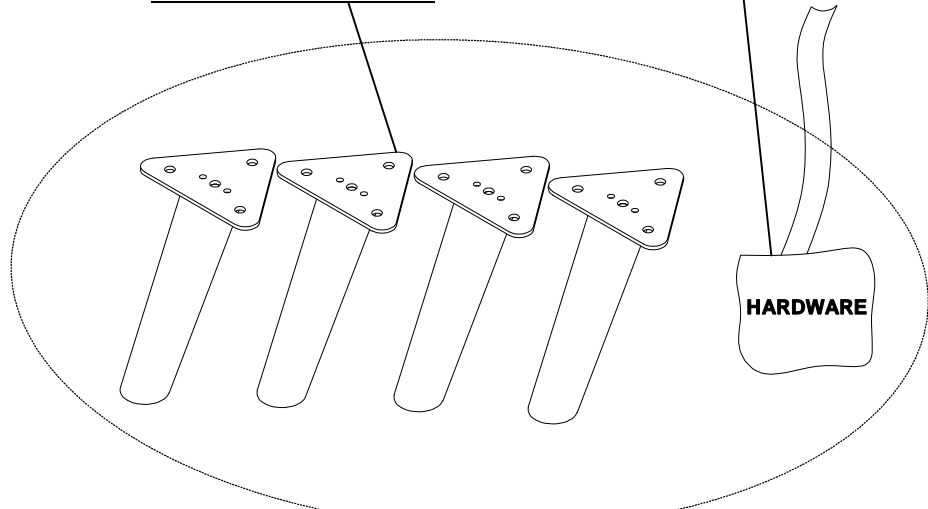

**WOODEN LEGS AND  
HARDWARE  
STORE UNDER THE  
SEAT CUSHION**

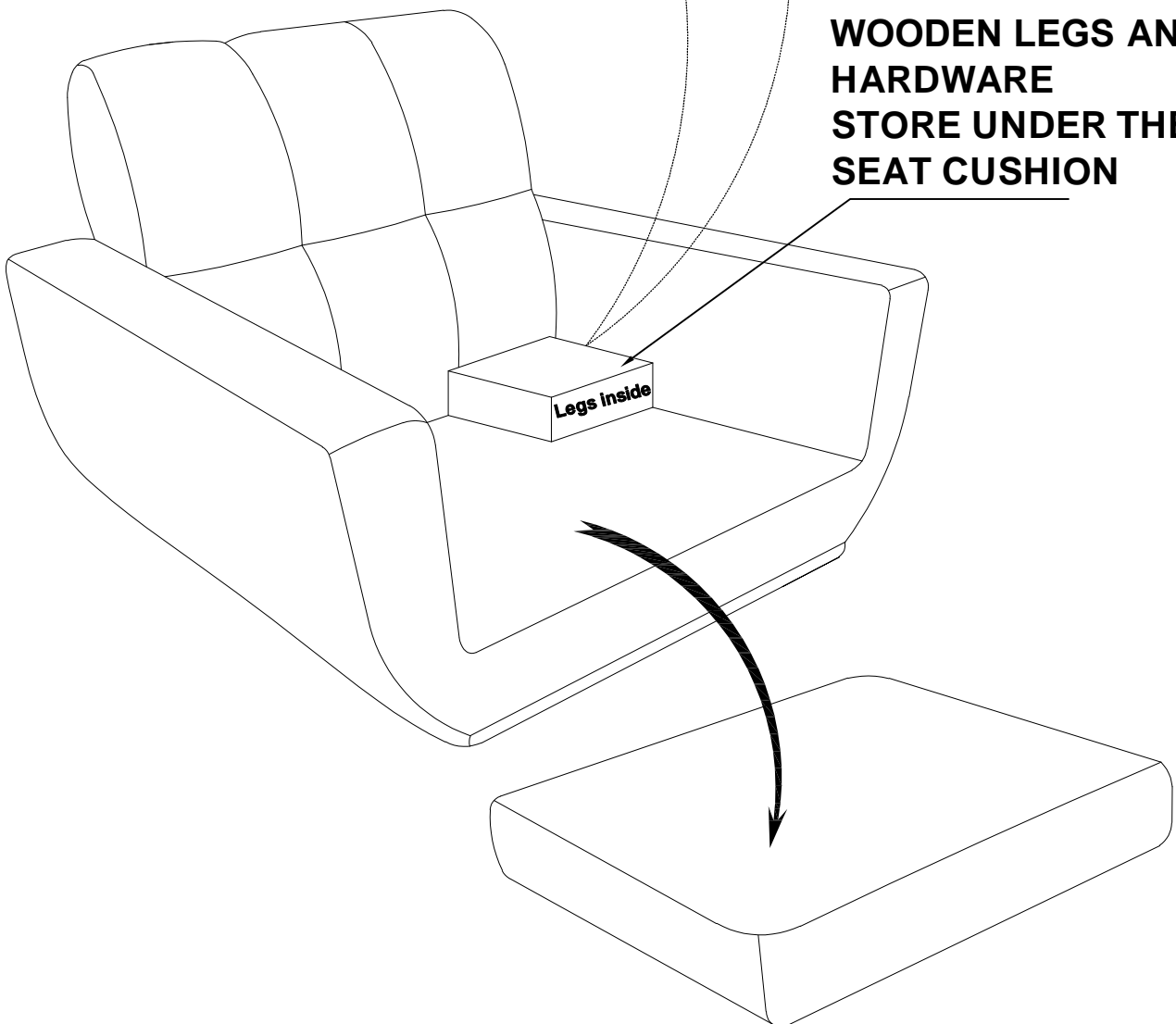

## Step #1

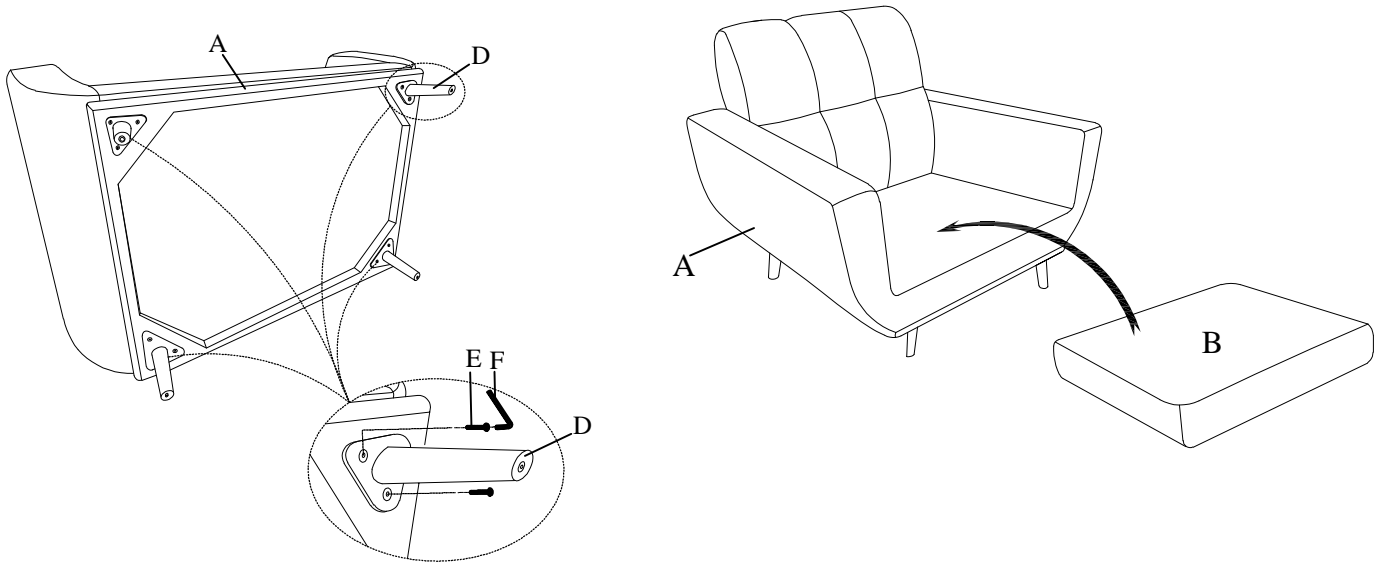

## Step #2

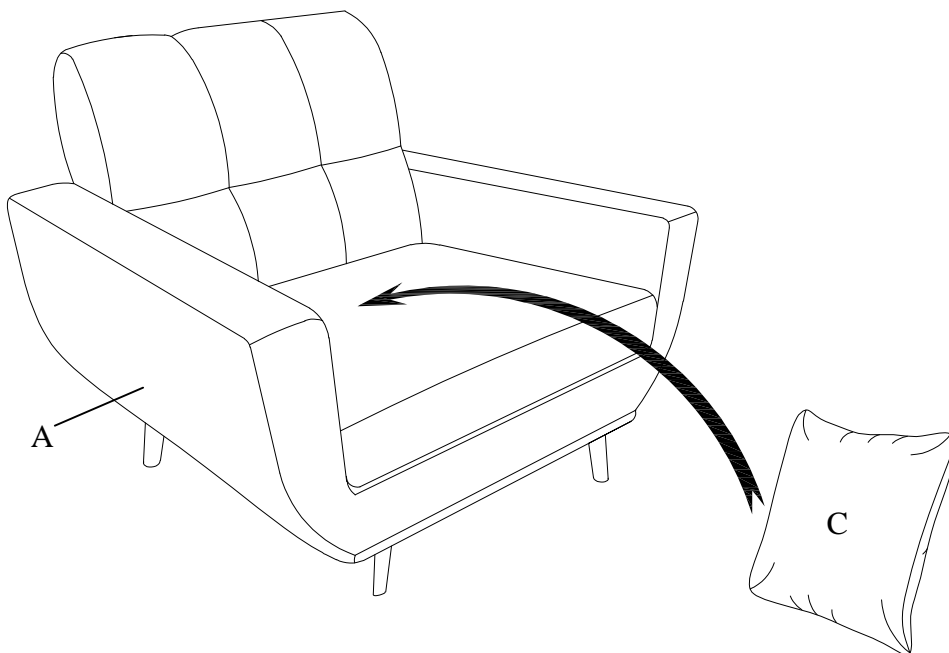

### **Step #3**

**Assembly completed.**

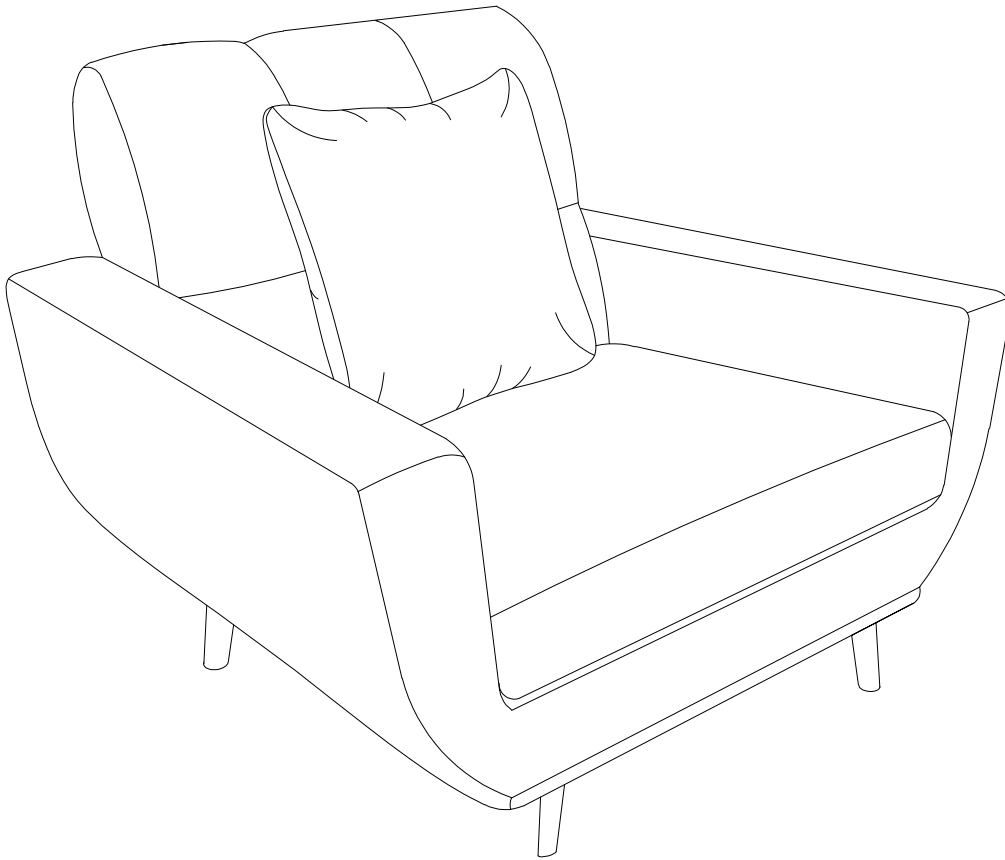

## **Care Instruction for fabric Furniture:**

**In order to maintain the original appearance of your fabric, please follow below simple care procedures:**

- **Avoid exposing furniture directly to sunlight or heating and air conditioning outlets. Sunlight and/or exposure to heating and air conditioning outlets will fade/damage chenille fabrics. Do not place your upholstered furniture too close to windows, radiators, or vents, and be sure to use windows, radiators, or vents.**
- **Vacuum or wipe with a soft cloth to remove dust.**
- **Hardware may loosen over time. Periodically check to make sure all connections are tight. Re-tighten if necessary.**



**For items use on wooden floor, hard surfaces or carpets, it is recommended to Install protective pads under all legs and supports to avoid/prevent from damages/scratches and discoloration.**



## ASSEMBLY INSTRUCTION LOVE SEAT



Legs & hardware are stored under the seat cushion, please take out the legs and hardware for assembly.

**Note:** Do not use power tools for assembly. Power tools increase the risk of over tightening which lead to spliting or cracking the wood.

### Component list

No	Drawing	Qty	Description
<b>A</b>		<b>1</b>	<b>Love Seat</b>
<b>B</b>		<b>2</b>	<b>Seat cushions</b>
<b>C</b>		<b>2</b>	<b>Pillows</b>
<b>D</b>		<b>4</b>	<b>Wooden legs (Ø40*Ø35*148mm)</b>
<b>E</b>		<b>12</b>	<b>Bolt (1/4*25mm)</b>
<b>F</b>		<b>1</b>	<b>Allen key (M4*59mm)</b>

**THE PARTS ARE LOCATED INSIDE THE BOX AS BELOW:**

**WOODEN LEGS**

**HARDWARE**

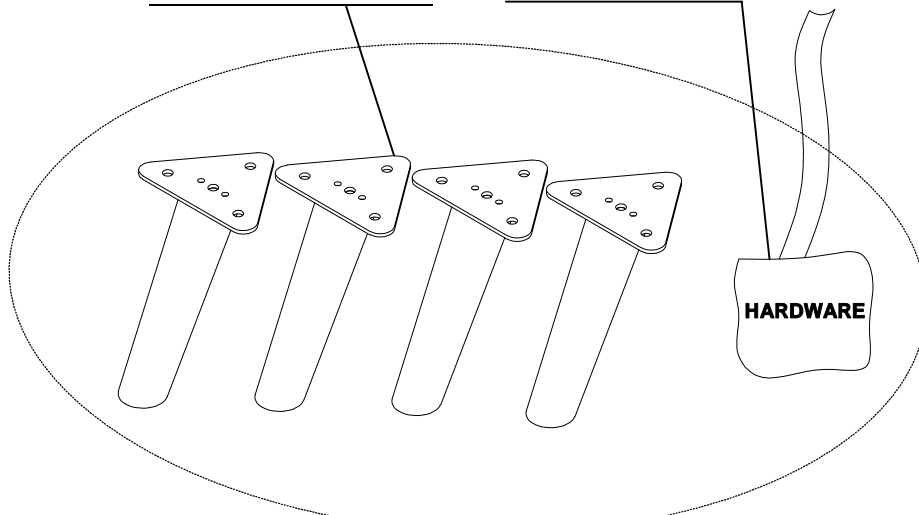

**WOODEN LEGS AND  
HARDWARE  
STORE UNDER THE  
SEAT CUSHION**

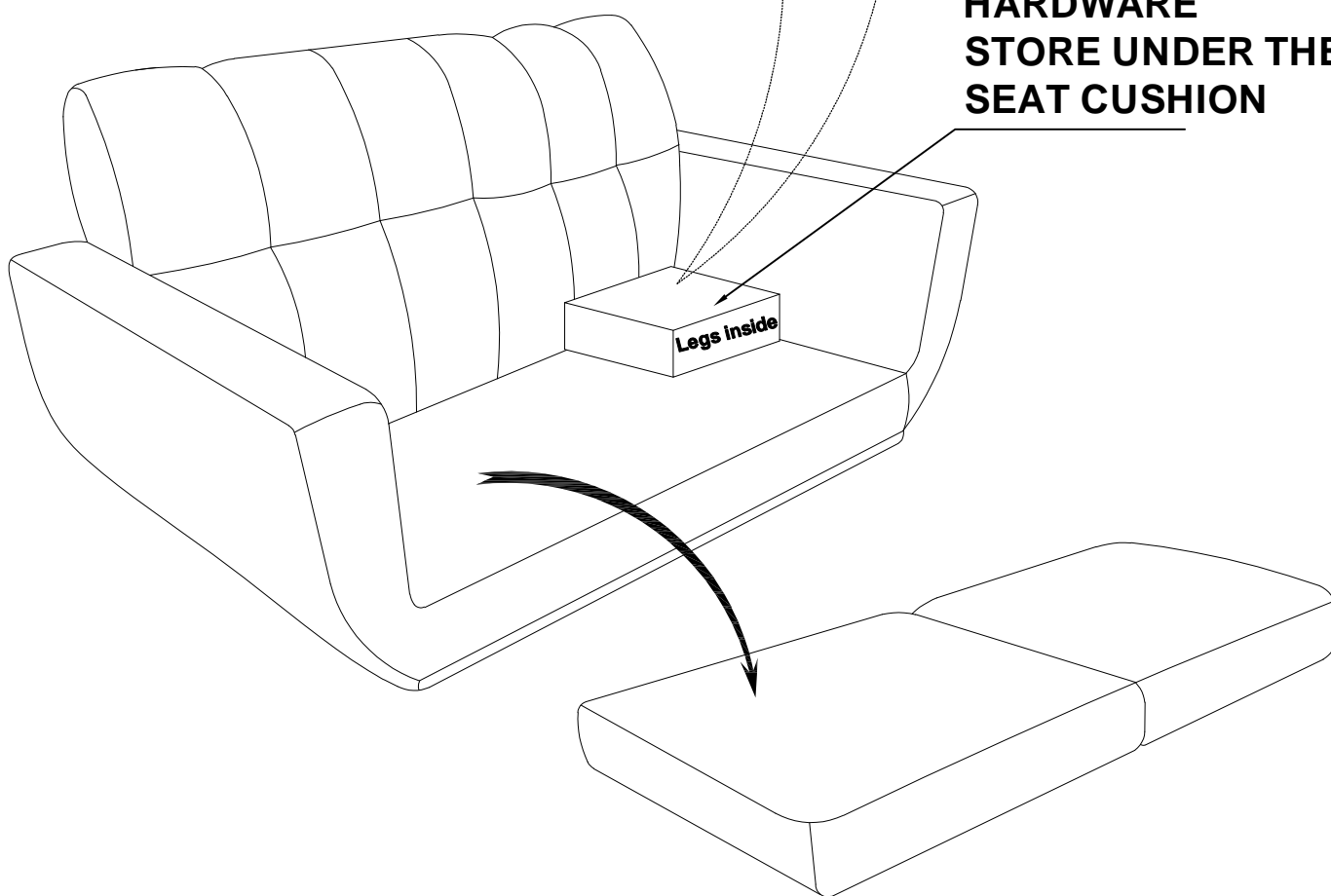

## Step #1

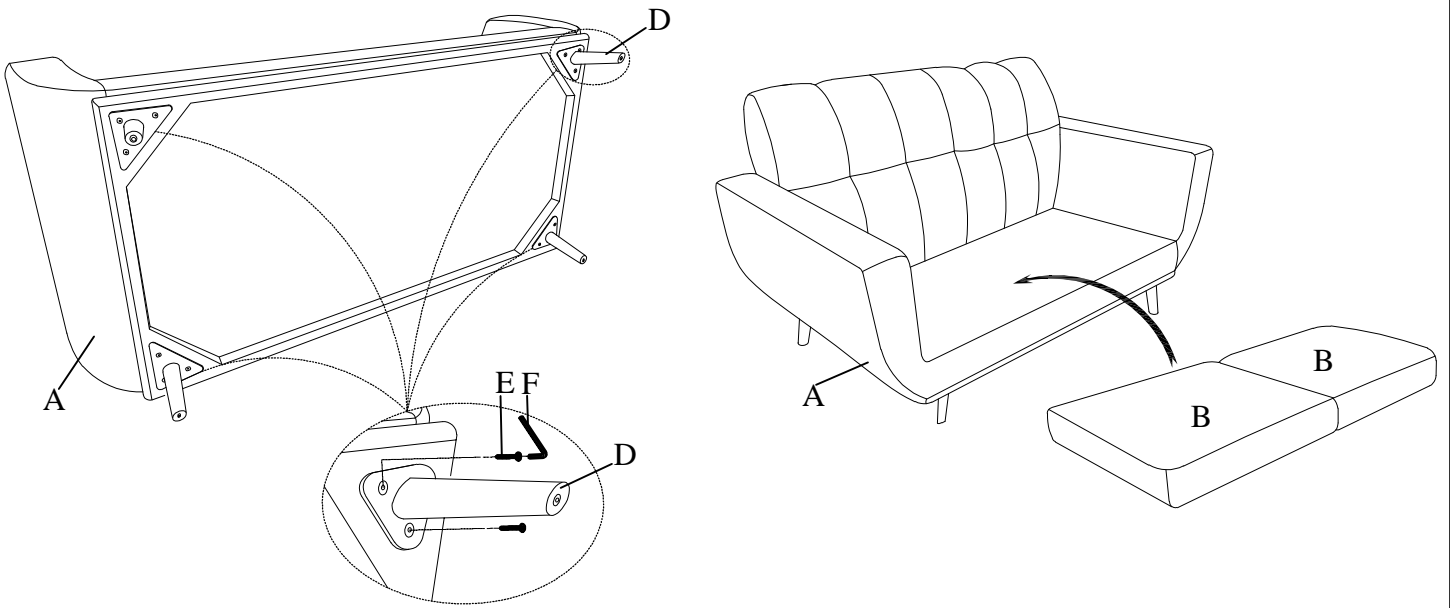

## Step #2

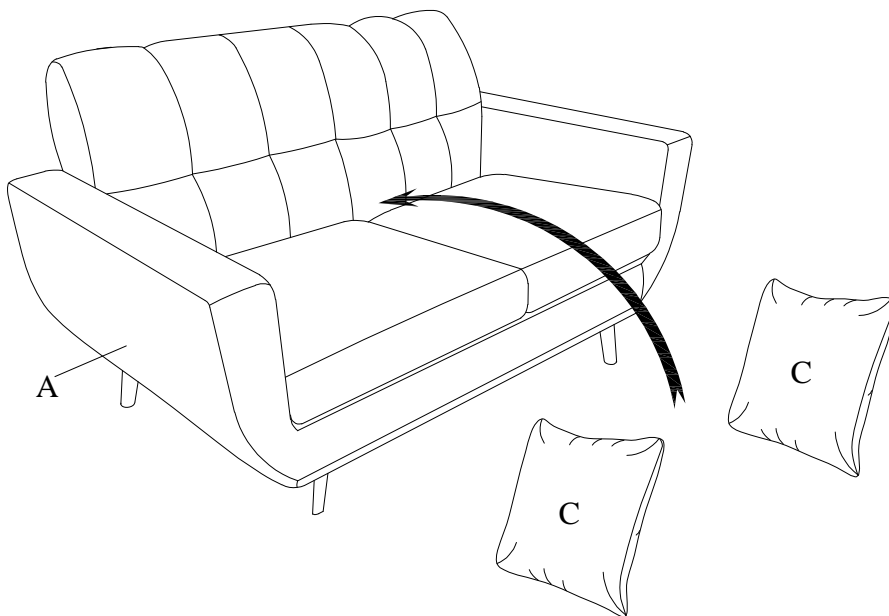

### **Step #3**

**Assembly completed.**

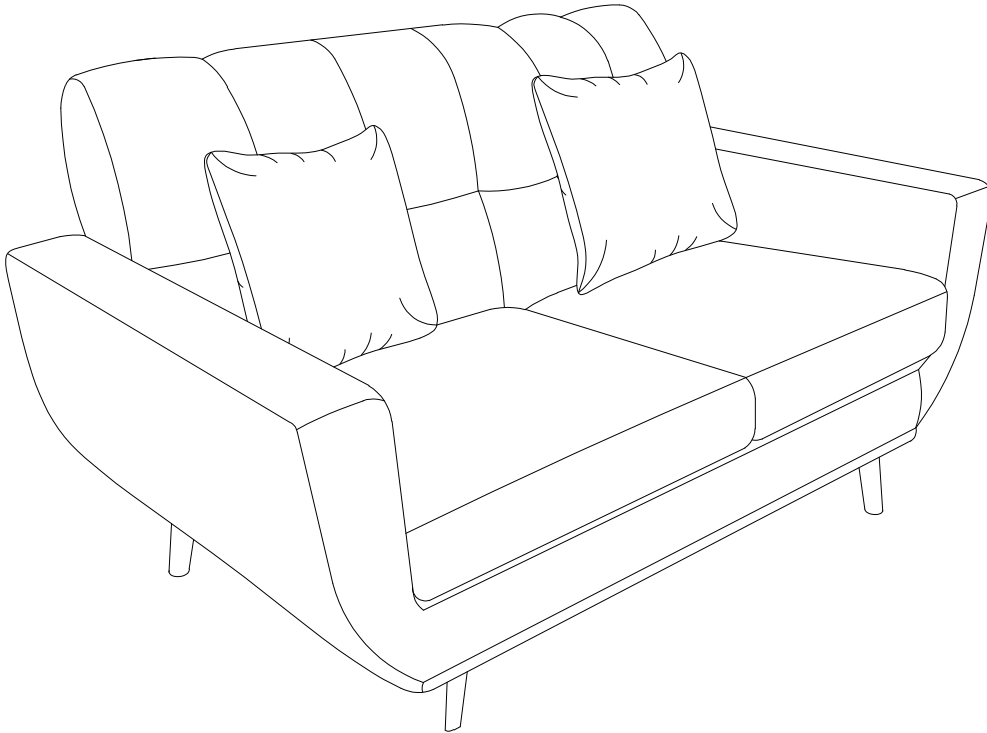

## **Care Instruction for fabric Furniture:**

**In order to maintain the original appearance of your fabric, please follow below simple care procedures:**

- **Avoid exposing furniture directly to sunlight or heating and air conditioning outlets. Sunlight and/or exposure to heating and air conditioning outlets will fade/damage chenille fabrics. Do not place your upholstered furniture too close to windows, radiators, or vents, and be sure to use windows, radiators, or vents.**
- **Vacuum or wipe with a soft cloth to remove dust.**
- **Hardware may loosen over time. Periodically check to make sure all connections are tight. Re-tighten if necessary.**



**For items use on wooden floor, hard surfaces or carpets, it is recommended to install protective pads under all legs and supports to avoid/prevent from damages/scratches and discoloration.**







## ASSEMBLY INSTRUCTION SOFA

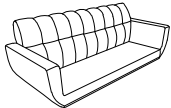
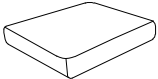

Legs & hardware are stored under the seat cushion, please take out the legs and hardware for assembly.

**Note:** Do not use power tools for assembly. Power tools increase the risk of over tightening which lead to splitting or cracking the wood.

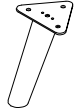
### Component list

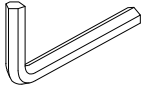
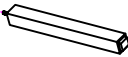
No	Drawing	Qty	Description
<b>A</b>		<b>1</b>	<b>Sofa</b>
<b>B</b>		<b>3</b>	<b>Seat cushions</b>
<b>C</b>		<b>2</b>	<b>Pillows</b>
<b>D</b>		<b>4</b>	<b>Wooden legs (Ø40*Ø35*148mm)</b>
<b>E</b>		<b>12</b>	<b>Bolt (1/4*25mm)</b>
<b>F</b>		<b>1</b>	<b>Allen key (M4*59mm)</b>
<b>G</b>		<b>1</b>	<b>Support leg (30*30*148mm)</b>

**THE PARTS ARE LOCATED INSIDE THE BOX AS BELOW:**

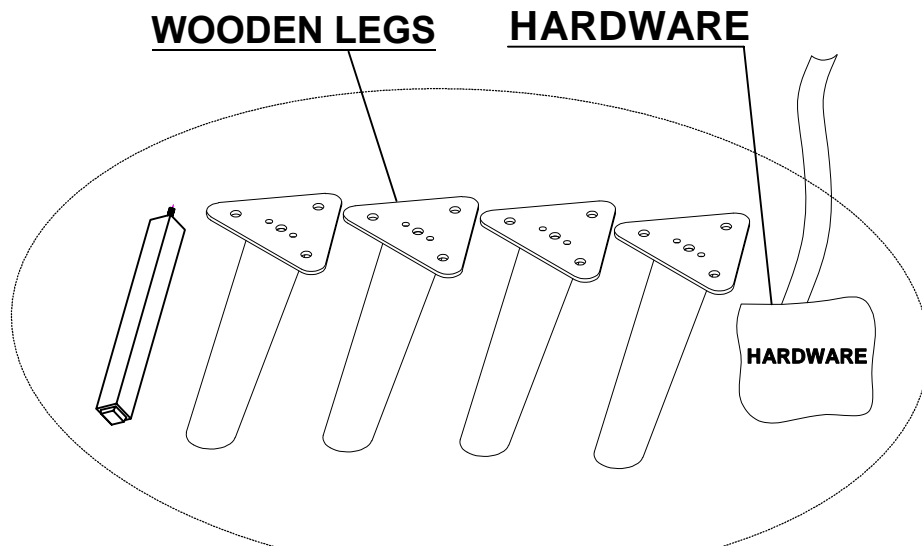

**WOODEN LEGS AND  
HARDWARE  
STORE UNDER THE  
SEAT CUSHION**

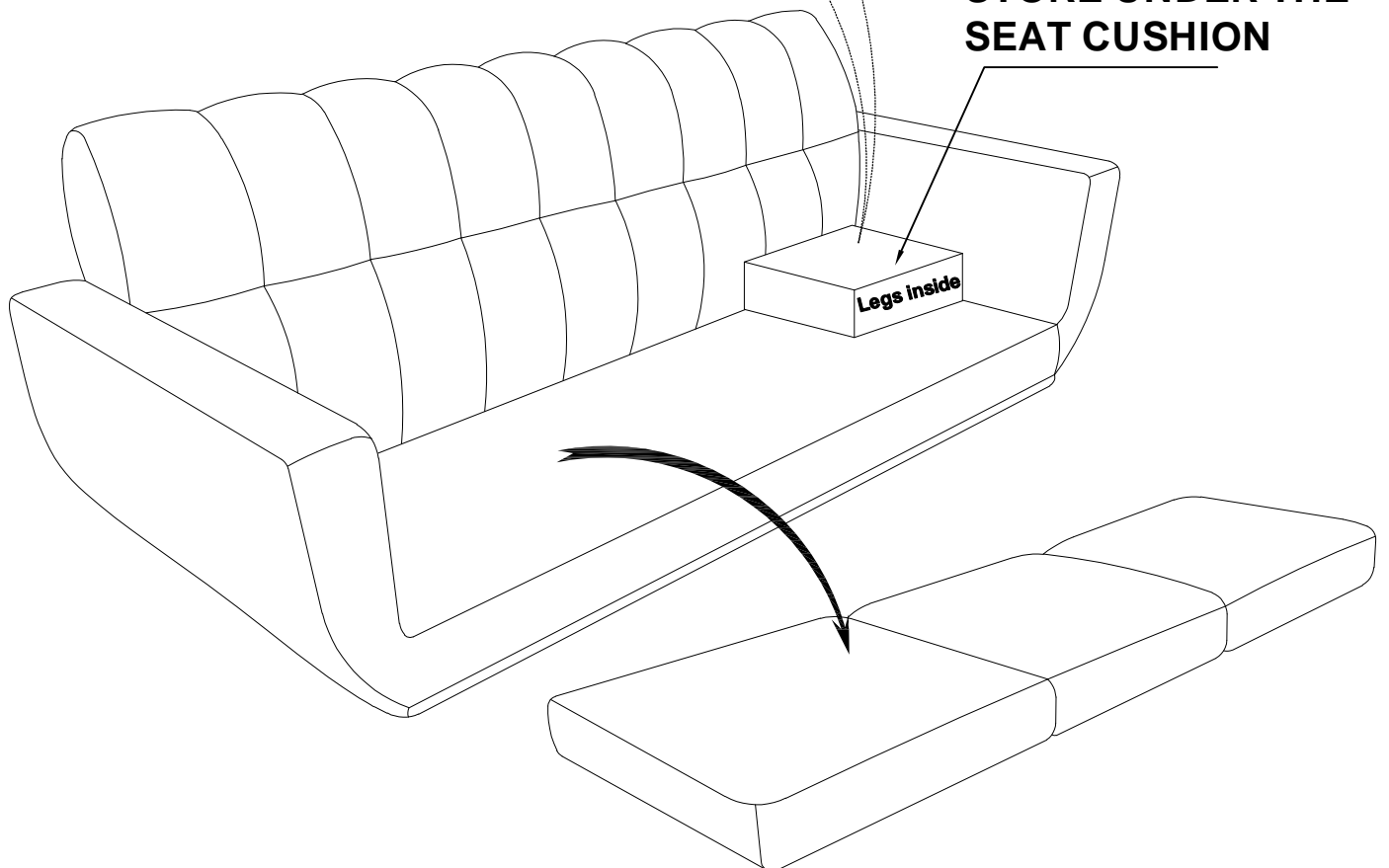

## Step #1

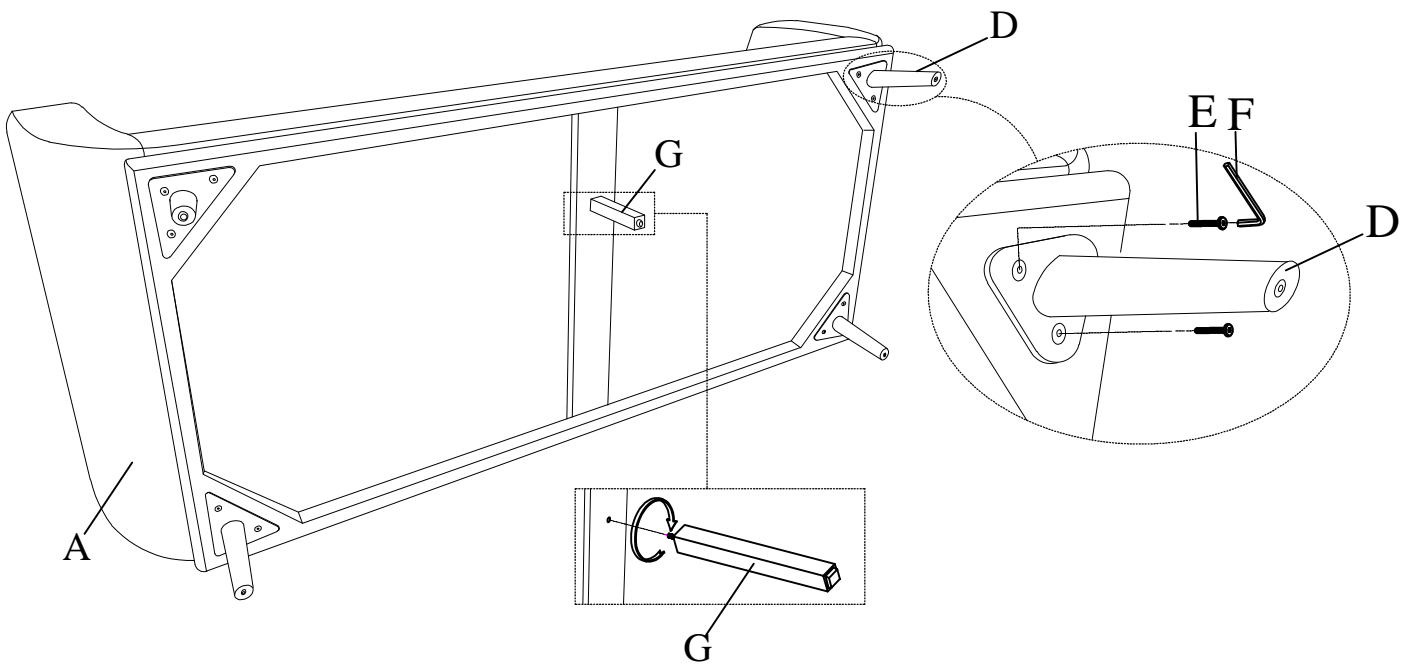

## Step #2

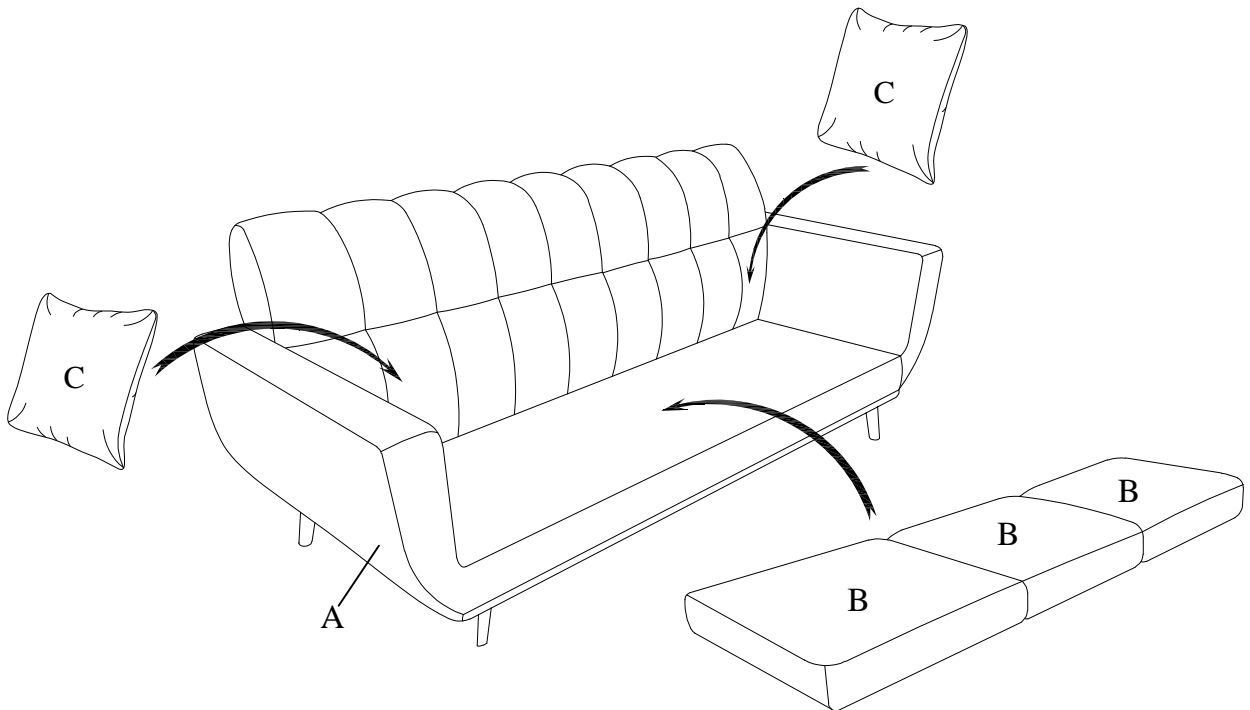

### **Step #3**

**Assembly completed.**

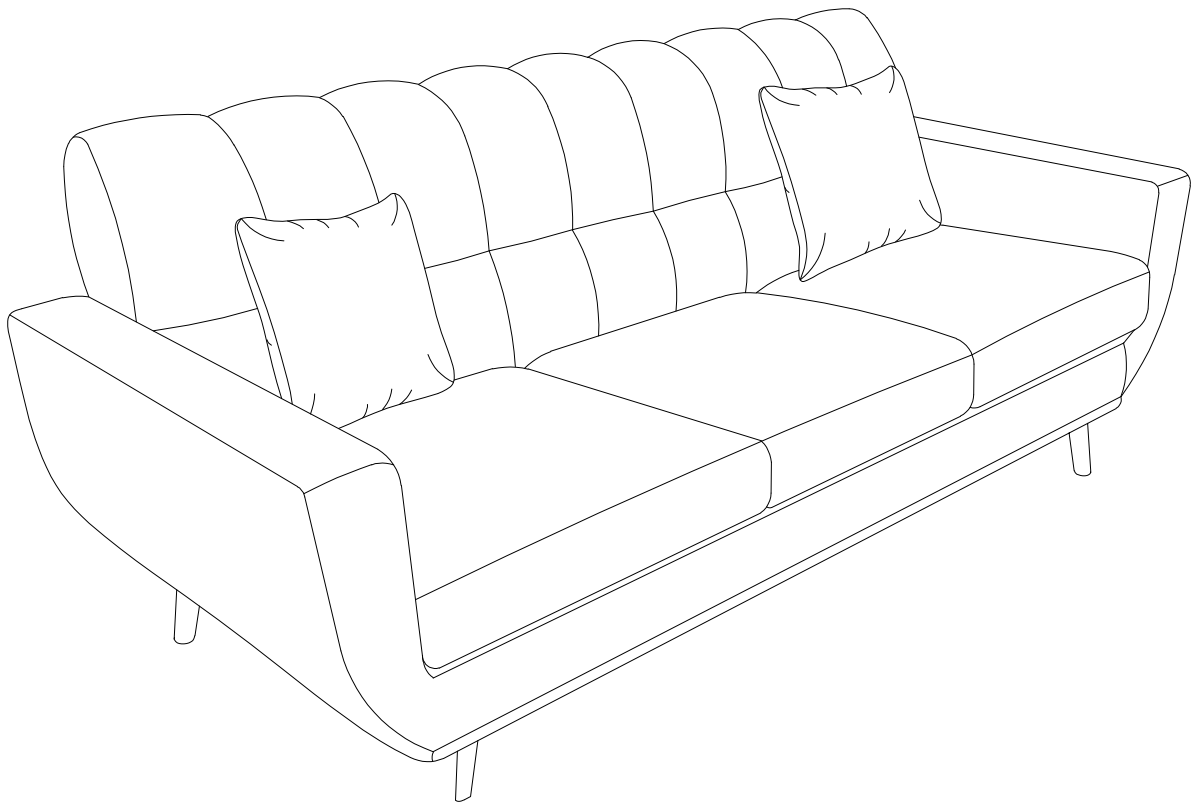

### **Care Instruction for fabric Furniture:**

In order to maintain the original appearance of your fabric, please follow below simple care procedures:

- Avoid exposing furniture directly to sunlight or heating and air conditioning outlets. Sunlight and/or exposure to heating and air conditioning outlets will fade/damage chenille fabrics. Do not place your upholstered furniture too close to windows, radiators, or vents, and be sure to use windows, radiators, or vents.
- Vacuum or wipe with a soft cloth to remove dust.
- Hardware may loosen over time. Periodically check to make sure all connections are tight. Re-tighten if necessary.



For items use on wooden floor, hard surfaces or carpets, it is recommended to install protective pads under all legs and supports to avoid/prevent from damages/scratches and discoloration.