

Assembly Instructions

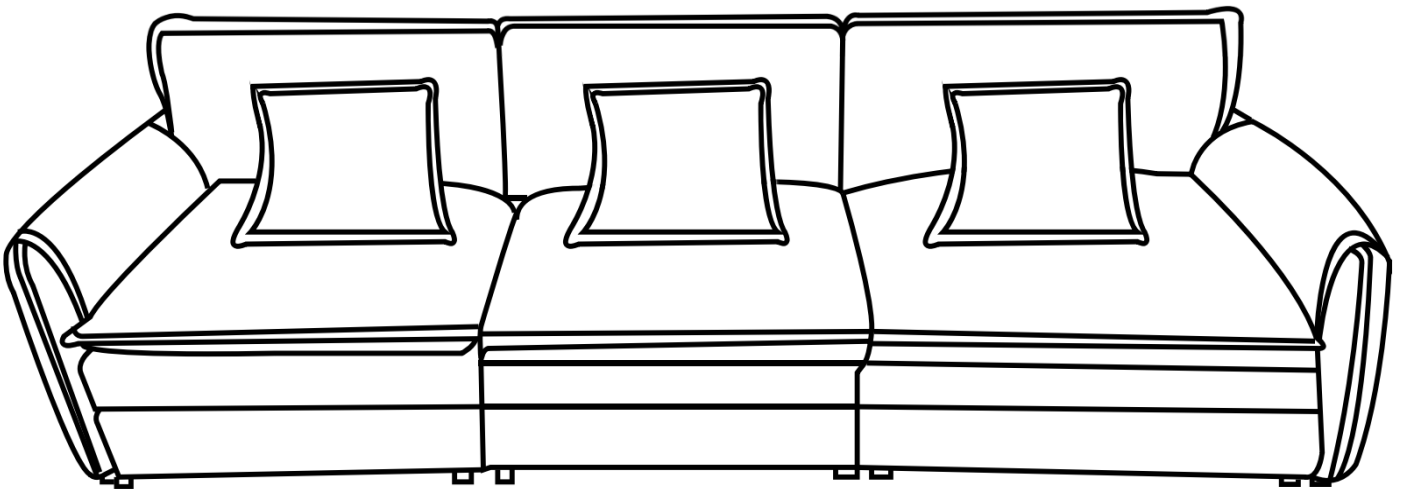

Safety and Care Advice

Important – Please read these instructions fully before starting assembly

Thanks for your purchase. Before assembling, please follow the instructions to check if all the spare parts and screws are intact.



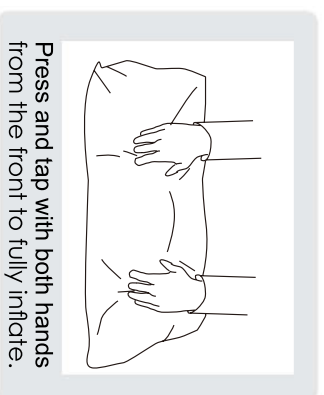

- Considering the size and weight of the sofa, we recommend two adults to assemble the sofa, on a carpeted or padded area, in the room that it is intended for. Approximate assembly time: 30 minutes.
- Please do not throw away any of the packaging or the instruction until you have checked all the components and hardware and the furniture is fully assembled. Please ensure that the packaging is disposed in a safe and environmentally friendly way.
- Keep all components and packaging out of reach of children or animals to avoid the risk of choking or suffocation.
- Please do not take off the cover, and do not wash.

Your cushions come vacuum packed and sealed for shipping. To restore the cushion's original shape, follow the steps below.



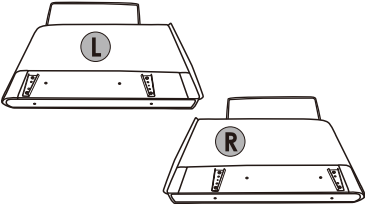
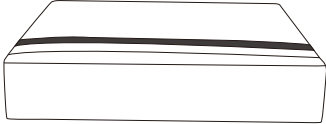
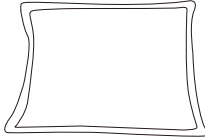
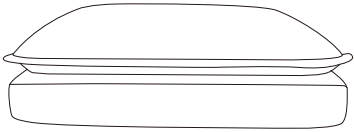
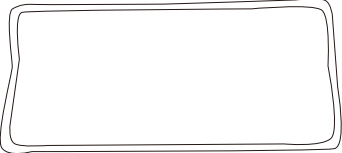
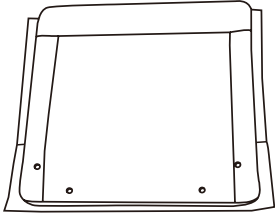
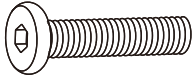

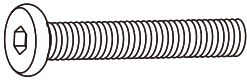

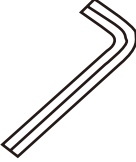
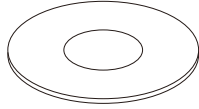
After packing up, place them in somewhere dry and ventilated. After about 72-96 hours. It can be restored to the best use condition.

Components List sku:W3163P365681/W3163P365693/W3163P365714/W3163P365729

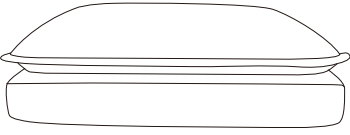
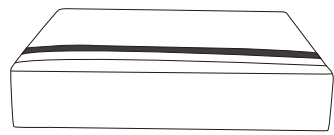
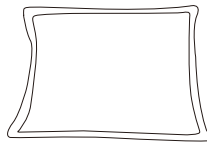
<p>A armrests</p>  <p>X2</p>	<p>B seat frame</p>  <p>X1</p>	<p>C pillow</p>  <p>X1</p>
<p>D seat cushion</p>  <p>X1</p>	<p>E back cushion</p>  <p>X1</p>	<p>F back frame</p>  <p>X1</p>
<p>G screws</p>  <p>M8*35MM</p> <p>X4</p>	<p>H armrest pillow</p>  <p>X2</p>	<p>I screws</p>  <p>M8*45MM</p> <p>X8</p>
<p>J chair legs</p>  <p>X8</p>	<p>K allen wrench</p>  <p>X1</p>	<p>M pads</p>  <p>X12</p>

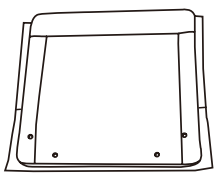
Components List sku:W3163P365686/W3163P365698/W3163P365717/W3163P365730

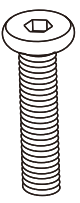
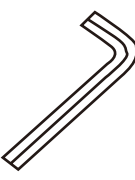
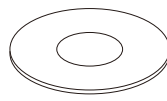
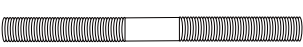
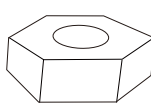
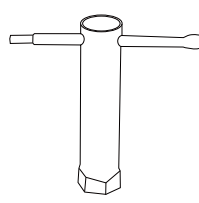
<p>D seat cushion</p>  <p>X1</p>	<p>B seat frame</p>  <p>X1</p>	<p>C pillow</p>  <p>X1</p>
<p>E back cushion</p>  <p>X1</p>	<p>F back frame</p>  <p>X1</p>	<p>J chair legs</p>  <p>X4</p>
<p>G M8*35MM</p>  <p>X4</p>	<p>K allen wrench</p>  <p>X1</p>	<p>M pads</p>  <p>X12</p>
<p>N double-sided screws</p>  <p>M8*60MM</p> <p>X4</p>	<p>O nuts</p>  <p>X8</p>	<p>P socket wrench</p>  <p>X1</p>

Components List sku:W3163P365691/W3163P365703/W3163P365720/W3163P365732

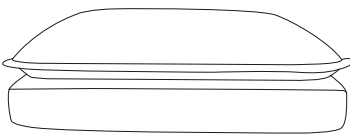
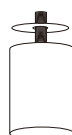
<p>N seat frame</p>  <p>X1</p>	<p>O seat cushion</p>  <p>X1</p>	<p>J chair legs</p>  <p>X4</p>
--	--	--

Assembly Instructions

STEP 1

Screw chair legs J into the hole at the bottom of armrest A

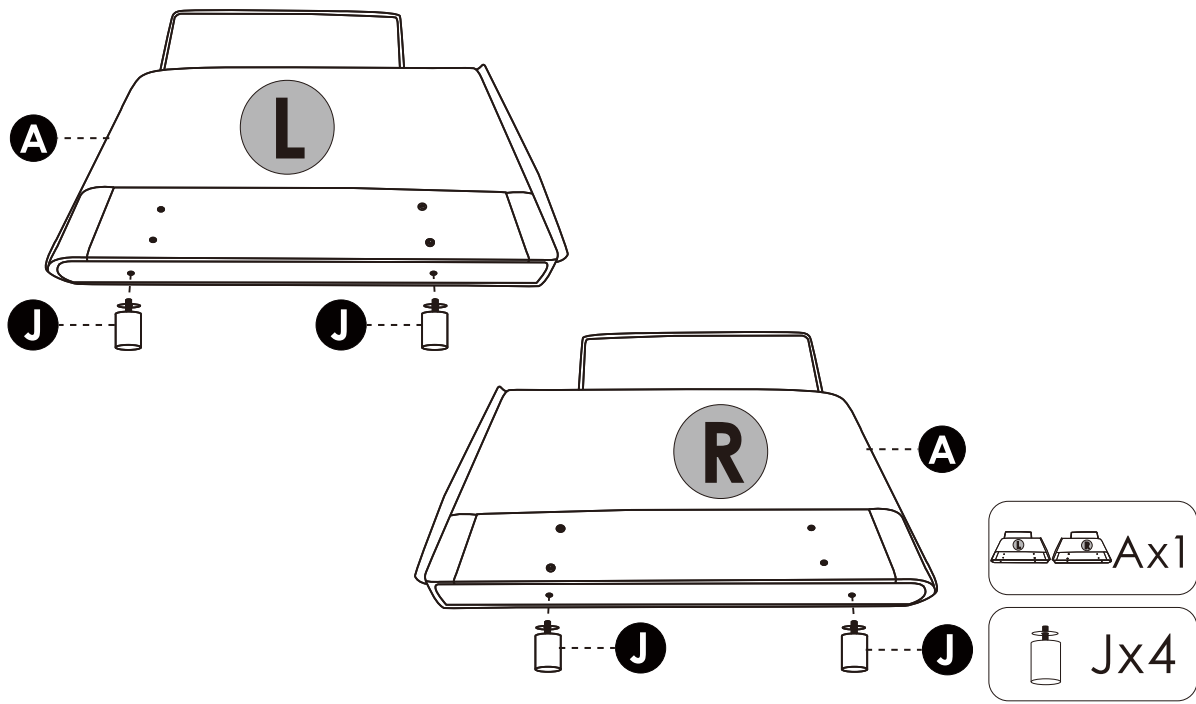

STEP 2

Turn the seat frame sideways, and screw chair legs J to the hole at the bottom.

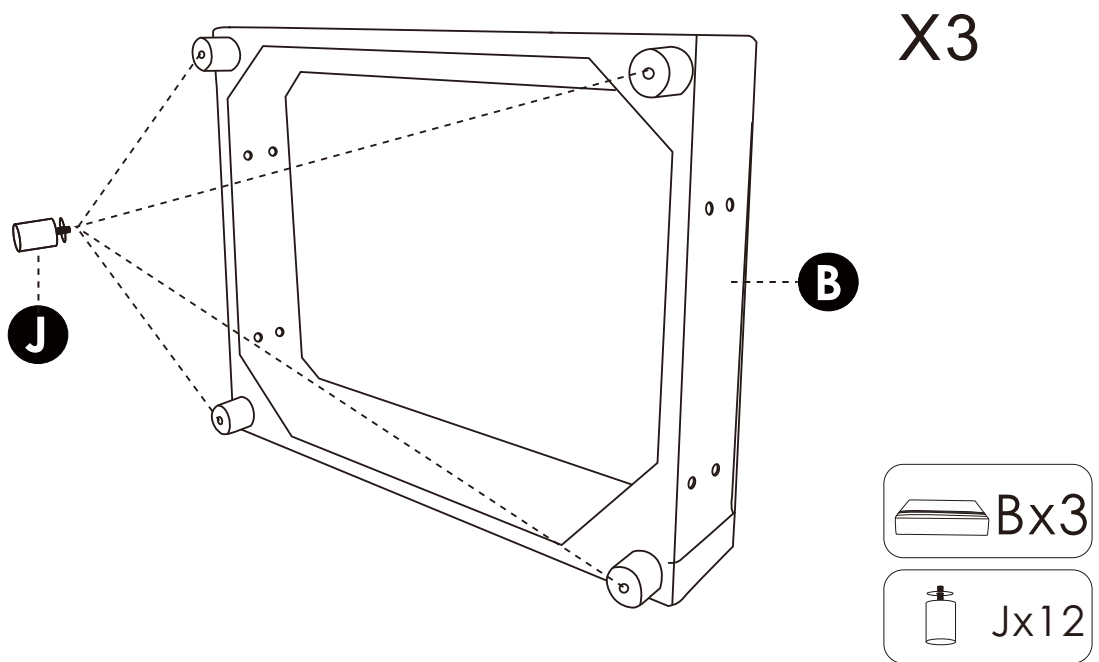

STEP 3

Align the back frame with seat frame and tighten them with screws

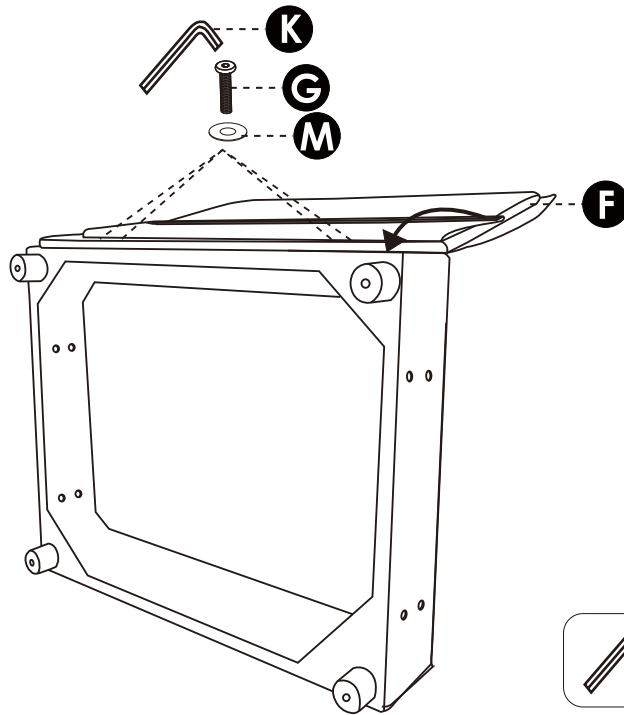

x3

x12

x3

x12

STEP 4

Connect the seat frame with double-sided screws and install in pads and nuts.

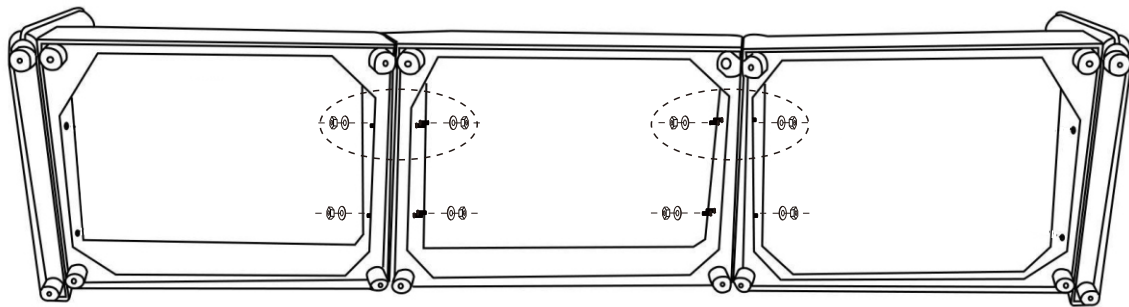

M O P

Nx 8

Mx16

Ox16

P

STEP 5

Connect the seat frame with double-sided screws and install in pads and nuts.

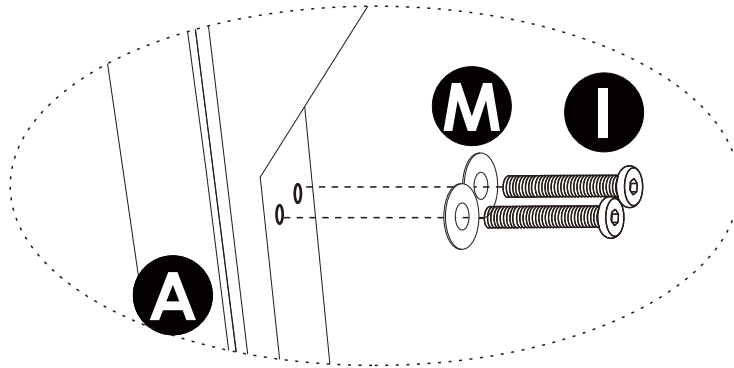
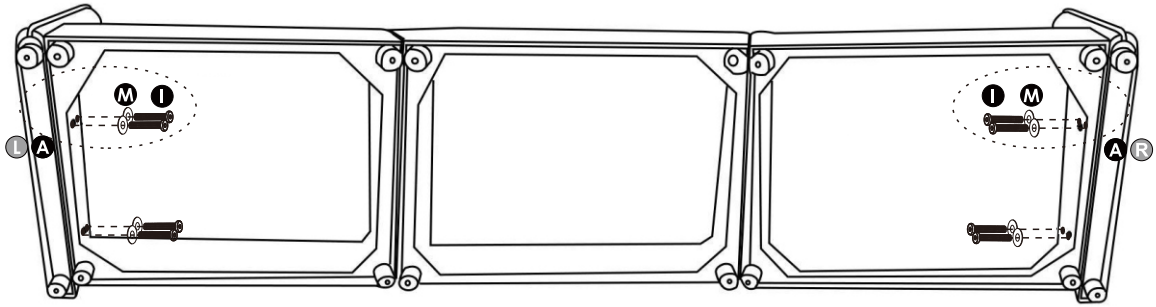

 Mx8



 I x8

STEP 6

Put the seat cushion, back cushion and pillow in order then make them fat.

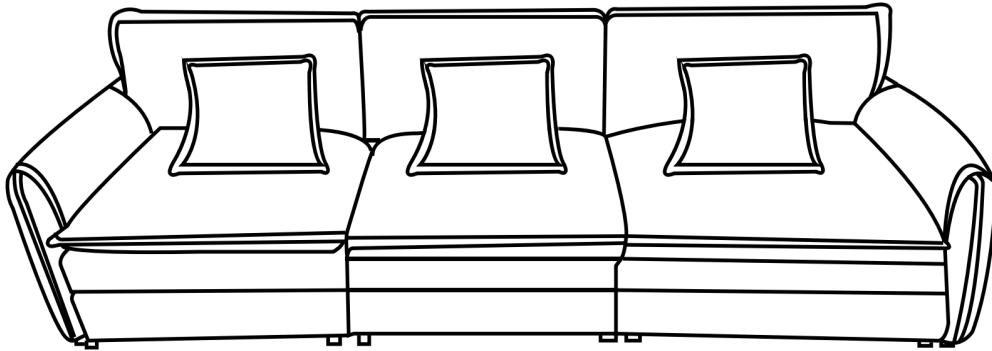

 x3

 x3

 x3

STEP 7

Unzip the armrest bag, stuff it with pillow H and make it flat.

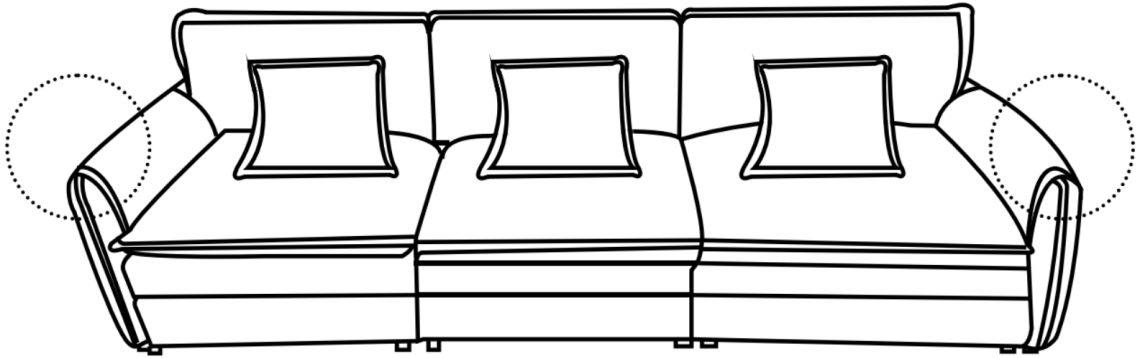
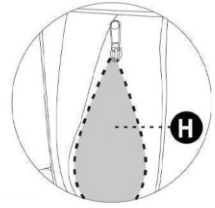
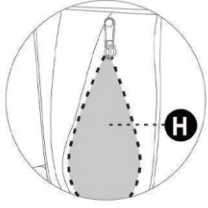

STEP 8

Installation is completed

