

ASSEMBLY INSTRUCTIONS

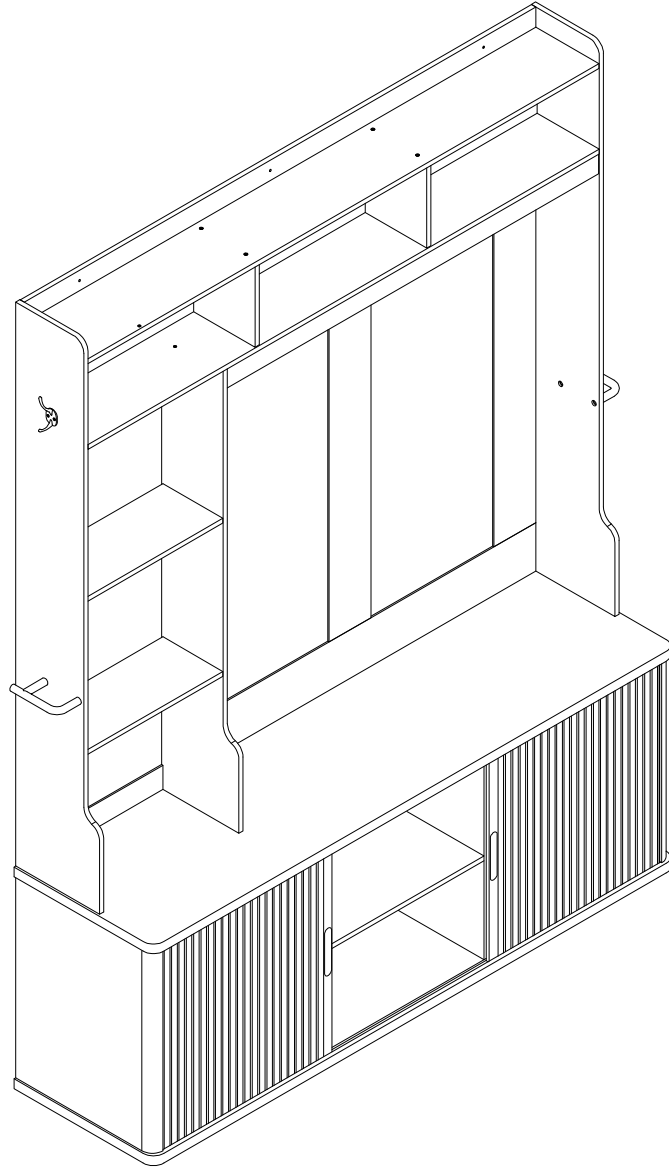

⚠ SAFETY TIPS:

Static charge may cause dust on foam-clean with a dry or damp cloth. Small foam strands may be present-handle gently and dispose of properly. Do not burn or incinerate. Check local recycling guideline.

Warnings

Important reminder:

- ⚠ Please sort and check all accessories before assembly.
- ⚠ Place the product on an empty cardboard box or on carpet to prevent scratches.
- ⚠ Please use proper tools for assembly. Using an electric screwdriver can accelerate the assembly speed, but please do not overtighten the screws.
- ⚠ Please follow the assembly steps and do not skip any of them.
- ⚠ If possible, please find a partner to help you with assembly, which can accelerate assembly.
- ⚠ Keep all small parts of this product away from children. They may cause serious injury.
- ⚠ We hope you can retighten the screws 2 weeks after assembly, and check the tightening procedure of the screws every 3 months.
If you meet any difficulty, our friendly customer team are always ready to help you.

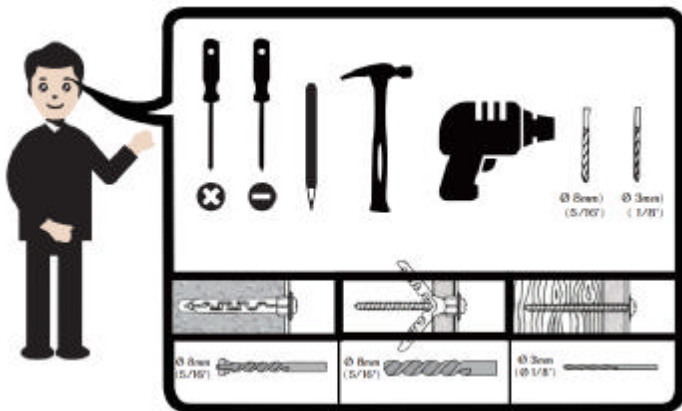





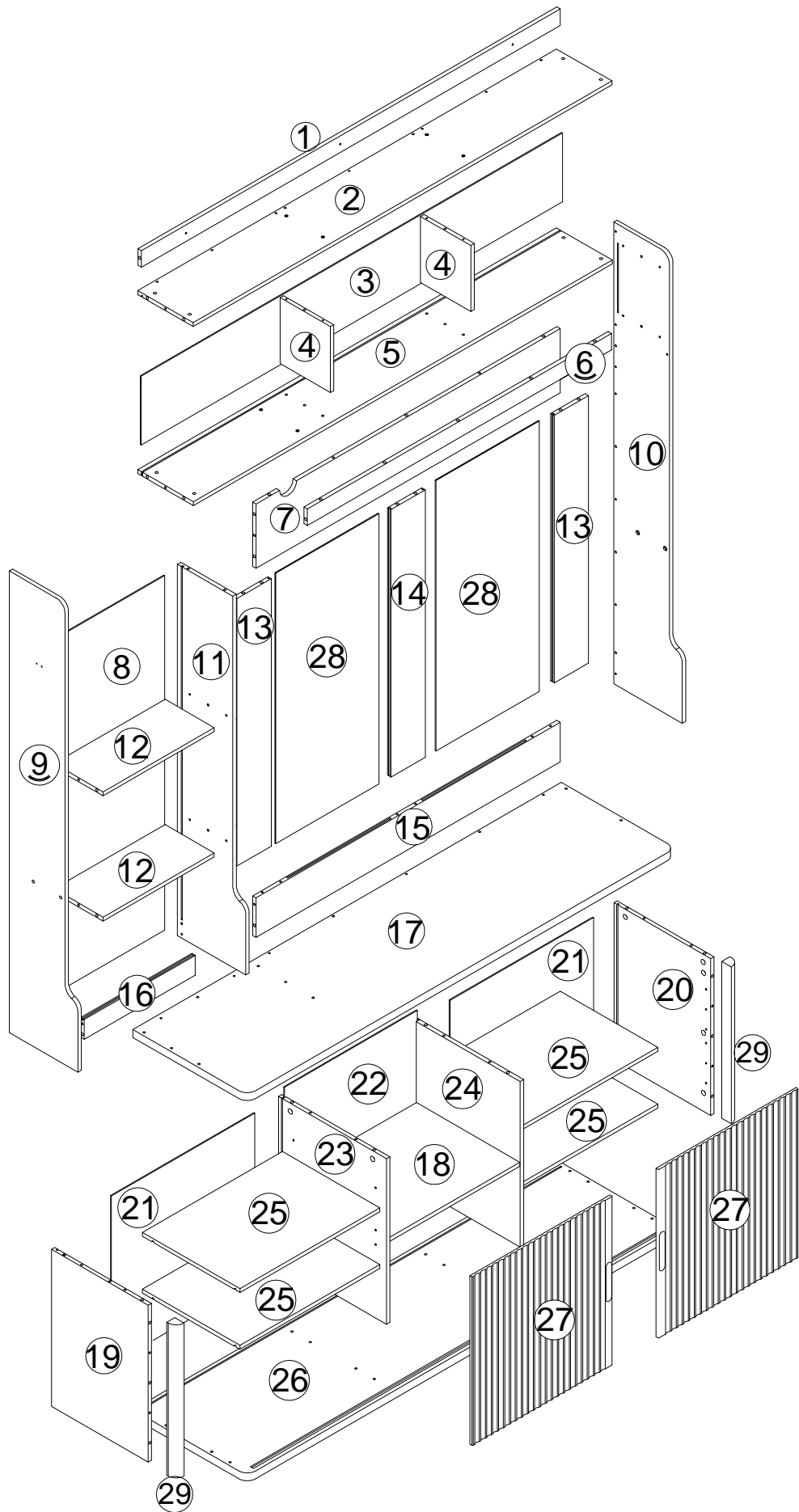

Note: This product requires two people to assemble together.

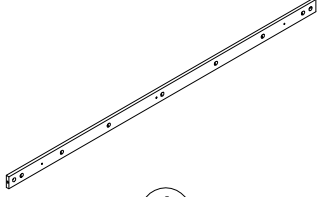
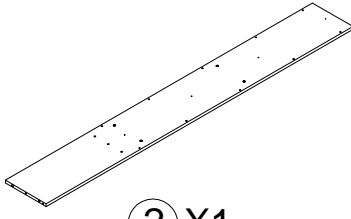
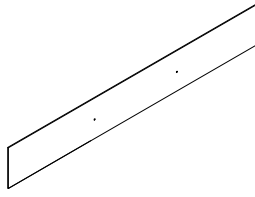
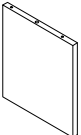
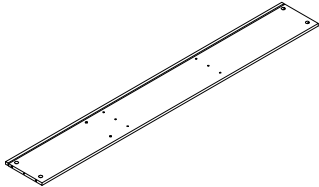
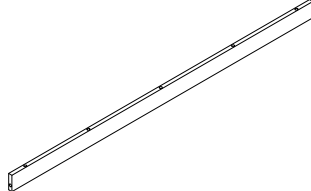
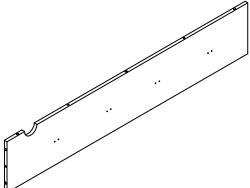
Explosion Diagram

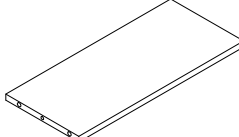
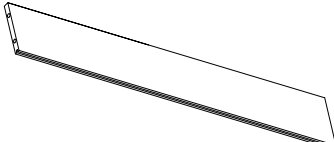

Parts List

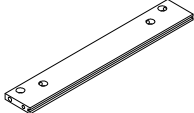
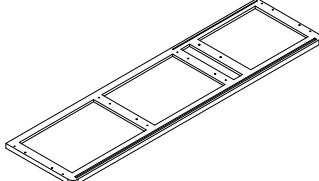
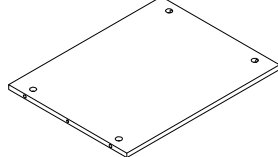
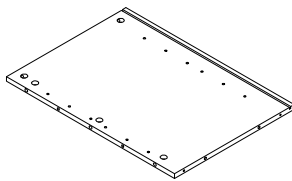
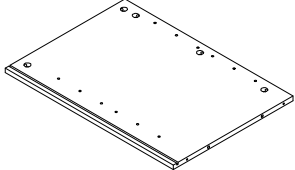
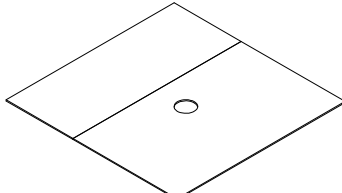
 <p>① X1</p>	 <p>② X1</p>	 <p>③ X1</p>
 <p>④ X2</p>	 <p>⑤ X1</p>	 <p>⑥ X1</p>
 <p>⑦ X1</p>	 <p>⑧ X1</p>	 <p>⑨ X1</p>
 <p>⑩ X1</p>	 <p>⑪ X1</p>	 <p>⑫ X2</p>
 <p>⑬ X2</p>	 <p>⑭ X1</p>	 <p>⑮ X1</p>
 <p>⑯ X1</p>	 <p>⑰ X1</p>	 <p>⑱ X1</p>
 <p>⑲ X1</p>	 <p>⑳ X1</p>	 <p>㉑ X2</p>

Parts List

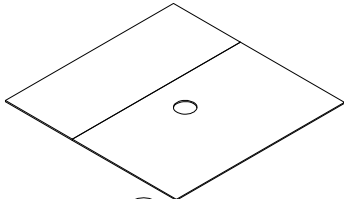

22 X1

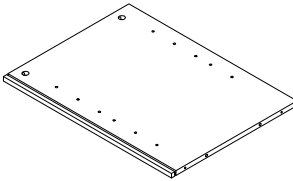

23 X1

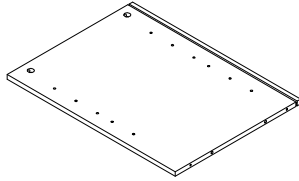

24 X1

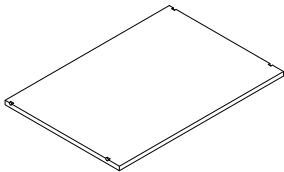

25 X4

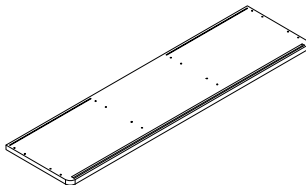

26 X1

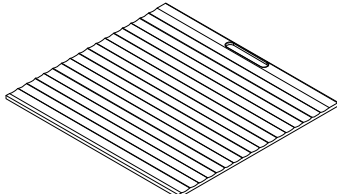

27 X2

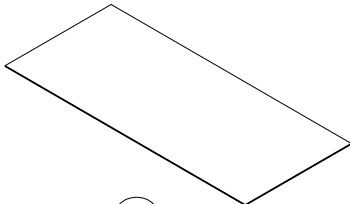



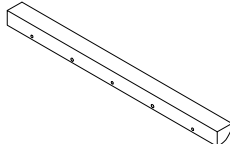







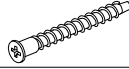



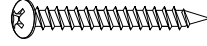



28 X2



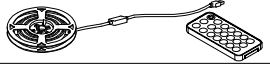

29 X2

Hardware List

No.	Code	Diagram	Description	Quantity	Spare
1	A		Ø6 x 33.5 mm	84	2
2	B		Ø15 x 9 mm	84	2
3	C		Ø6 x 30 mm	54	2
4	D		Ø5 x 38 mm	24	2
5	E		Ø5 x 15 mm	16	2
6	F		M6 x 20 mm	4	
7	G		Ø16mm	3	
8	H		Ø4 x 35 mm	3	
9	J			3	
10	K			26	2
11	L		Ø3 x 17 mm	26	2
12	M		Ø25	84	2
13	N			6	
14	P		Ø3.5 x 12 mm	12	2
15	Q		Ø3 x 14 mm	4	
16	R			1	
17	S		Ø3 x 12 mm	4	
18	T			4	
19	Z			1	
20	V			2	

THE SPARE BAG INCLUDED EXTRA HARDWARE FOR DAMAGED OR MISSING SMALL HARDWARE WHILE YOU ARE ASSEMBLING

Hardware List

No.	Code	Diagram	Description	Quantity	Spare
21	W			6	
22	X			8	
23	Y		M4	1	

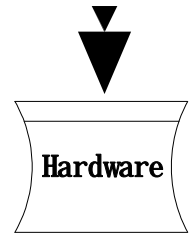

Spare parts
are packed
together in
one package.



THE SPARE BAG INCLUDED EXTRA HARDWARE FOR DAMAGED OR MISSING SMALL HARDWARE WHILE YOU ARE ASSEMBLING

Assemble

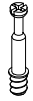
Step 1

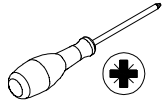
			
A	12PCS	B	6PCS

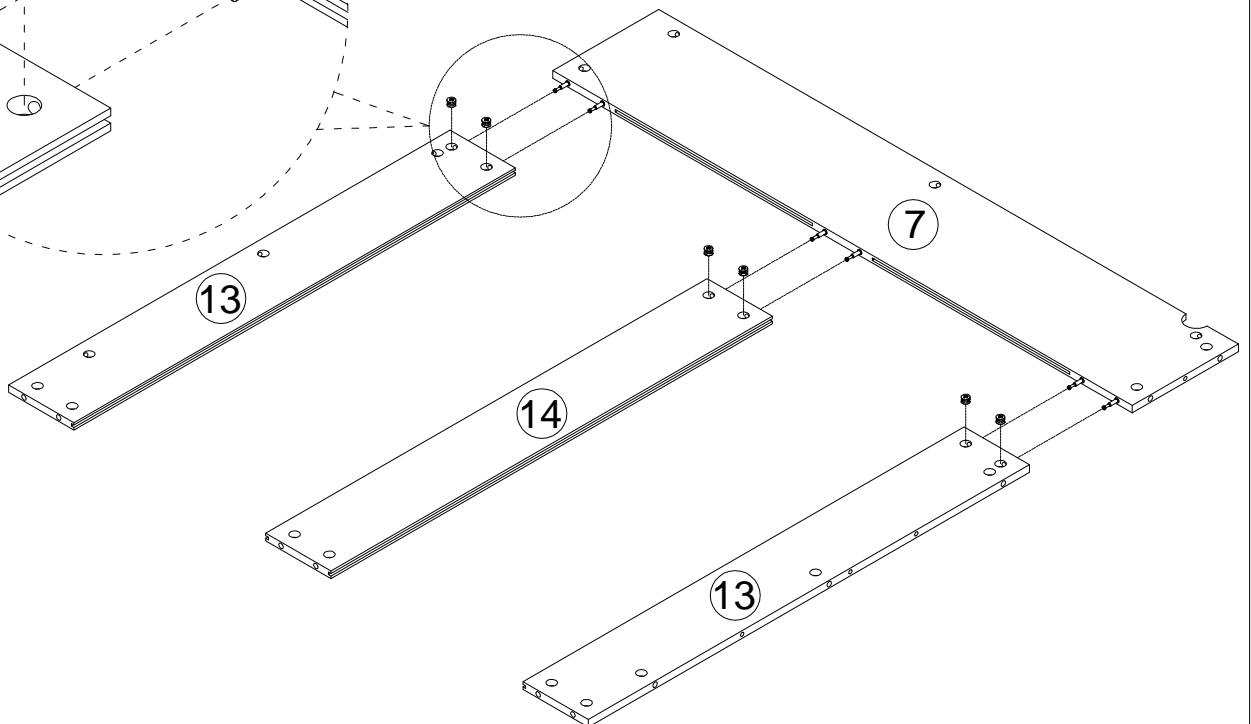
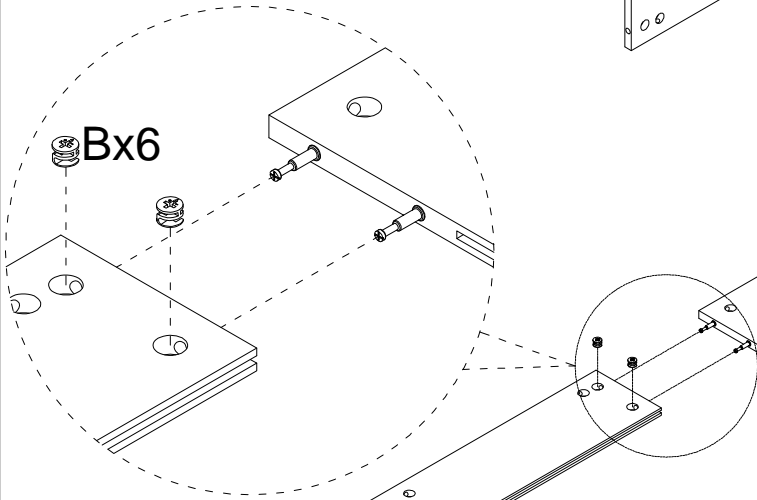
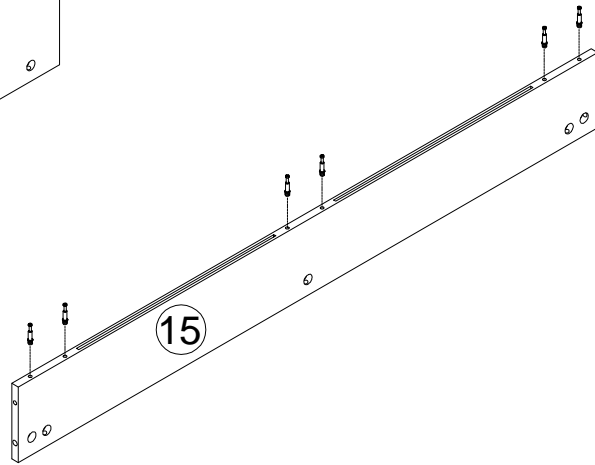
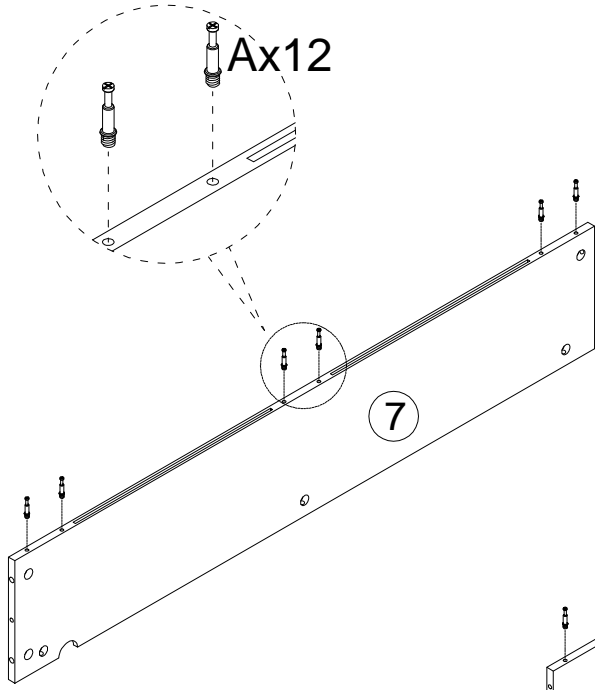
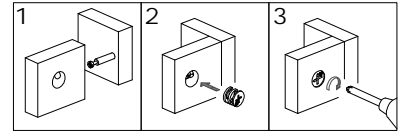
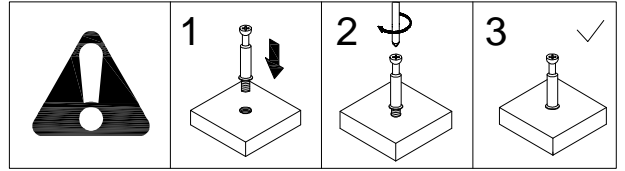



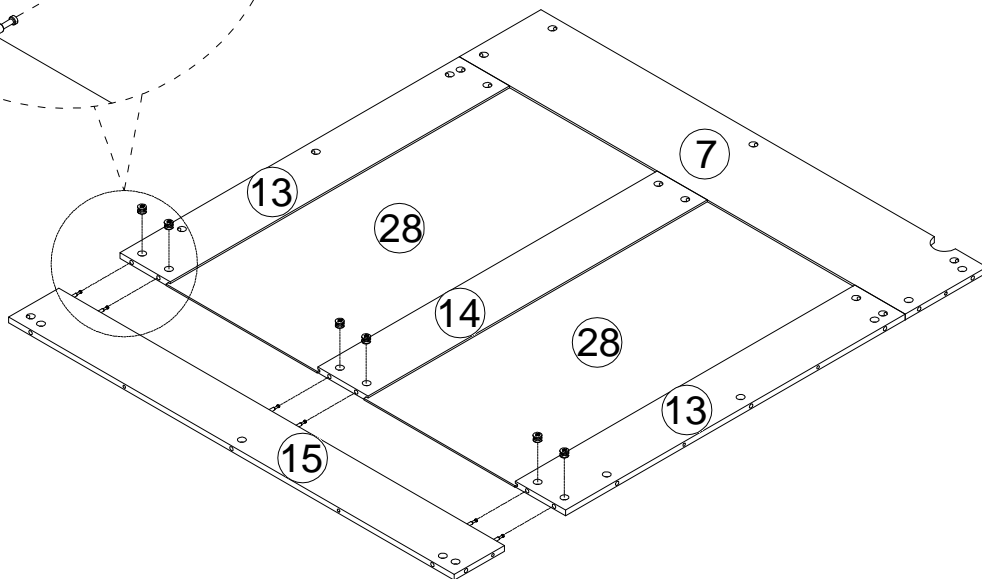
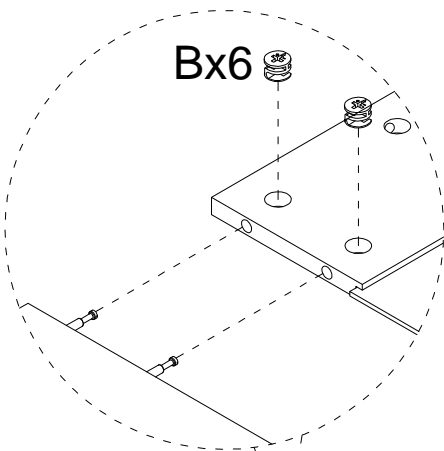
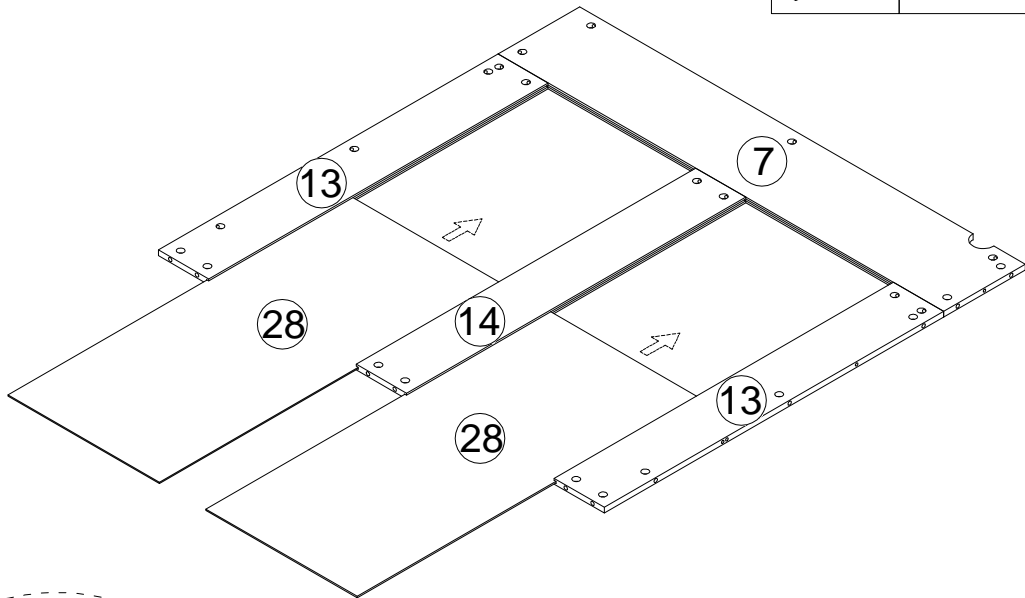
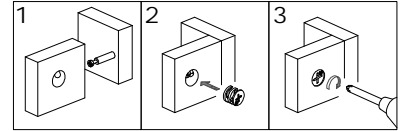
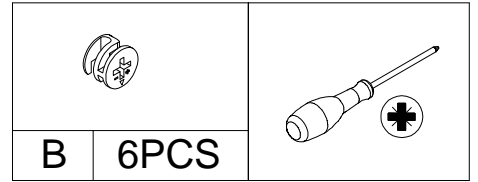

Assemble

Step 2

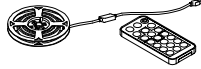

Assemble

Step 3

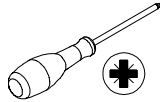

							
A	8PCS	B	5PCS	R	1PC	S	4PCS

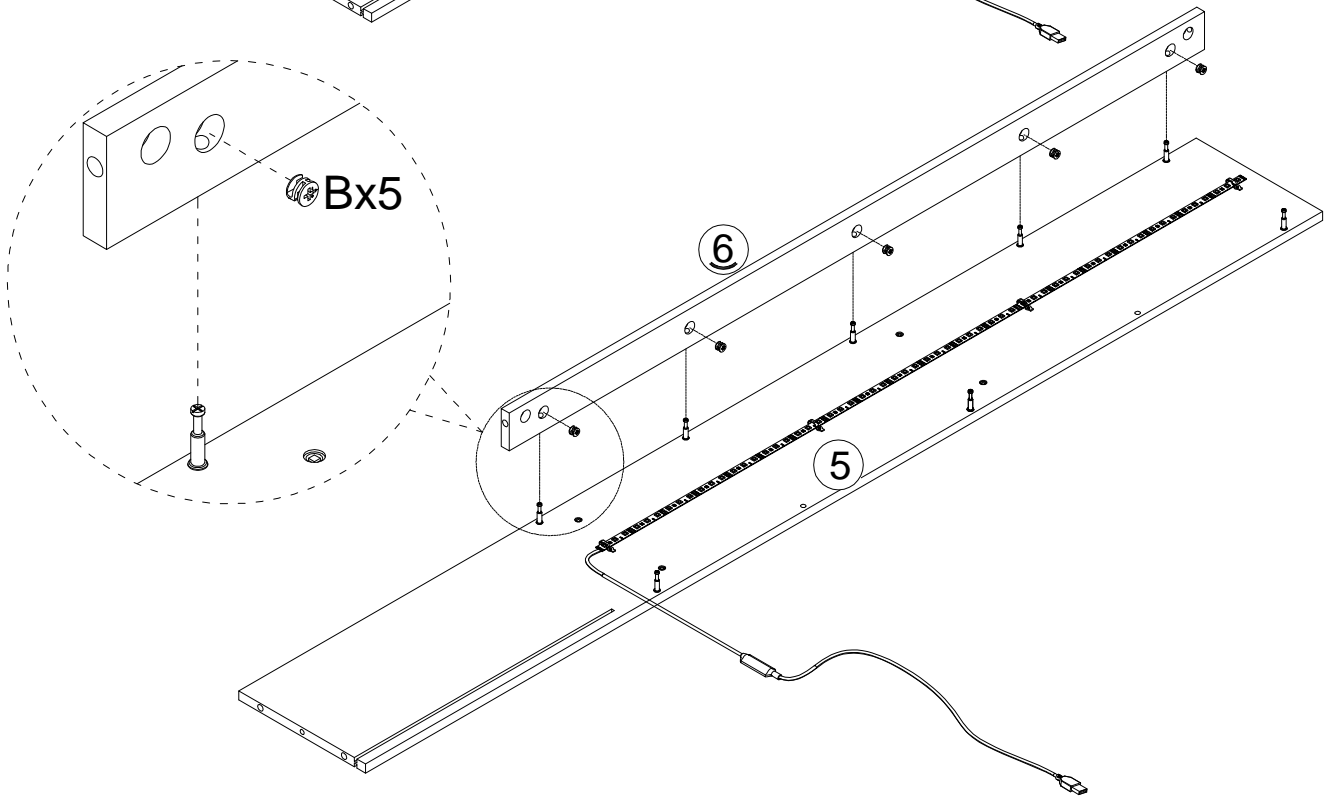
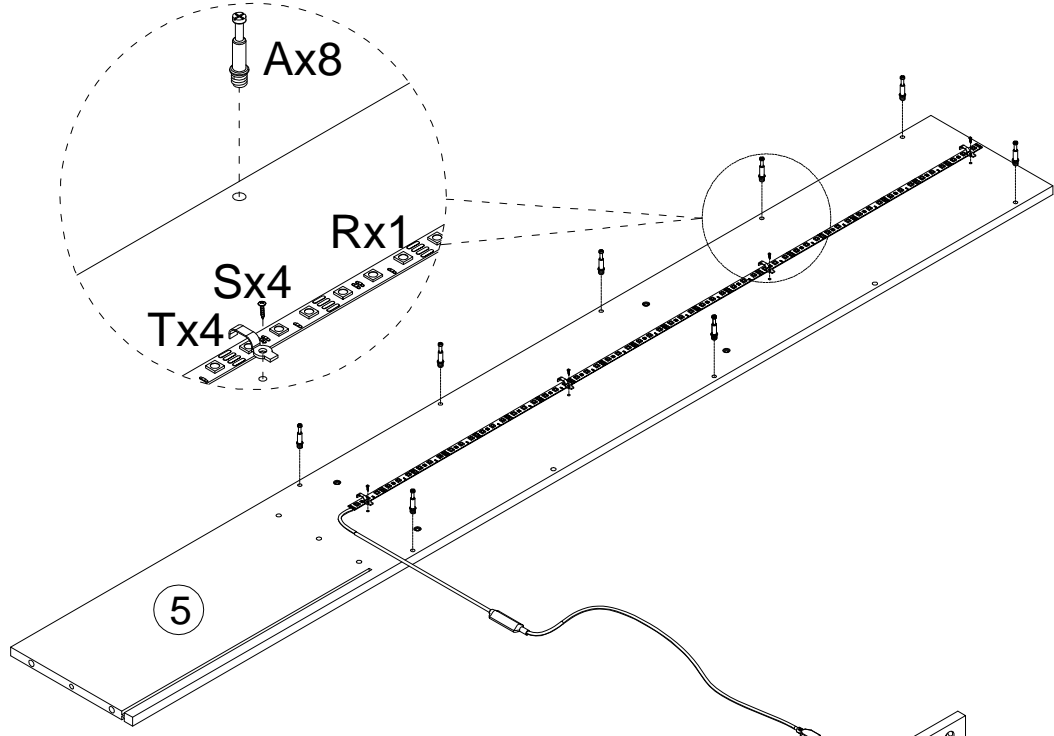
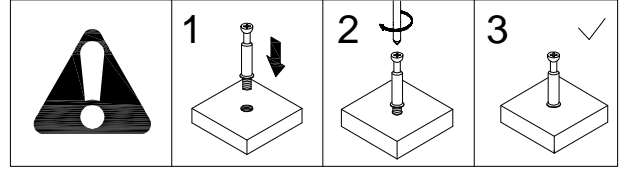
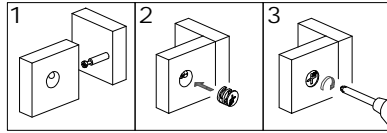
	T	4PCS
---	---	------



Assemble

Step 4

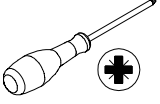

				
C	2PCS	D	4PCS	

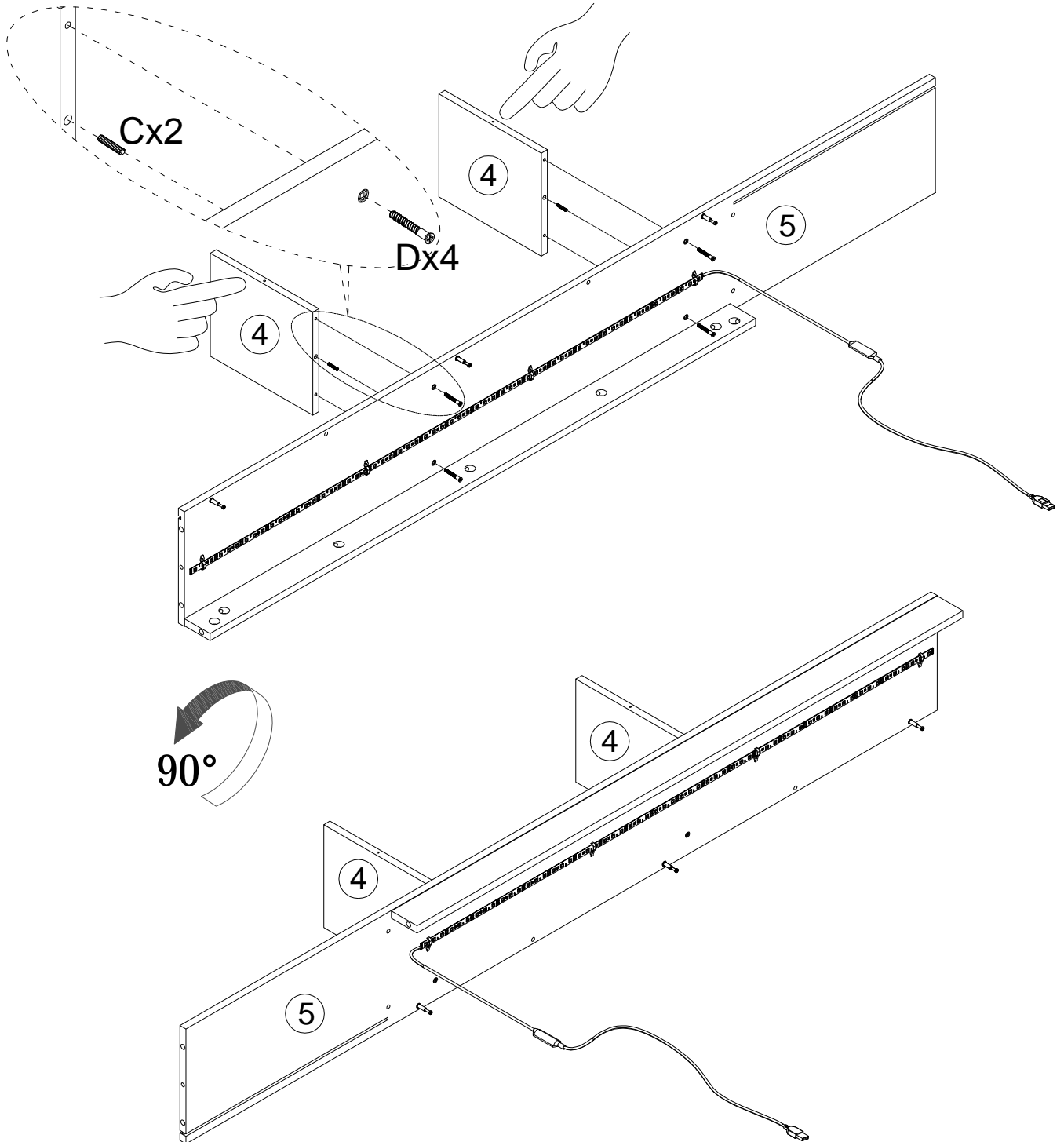
Note: Hole orientation



Assemble



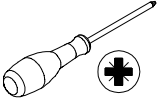

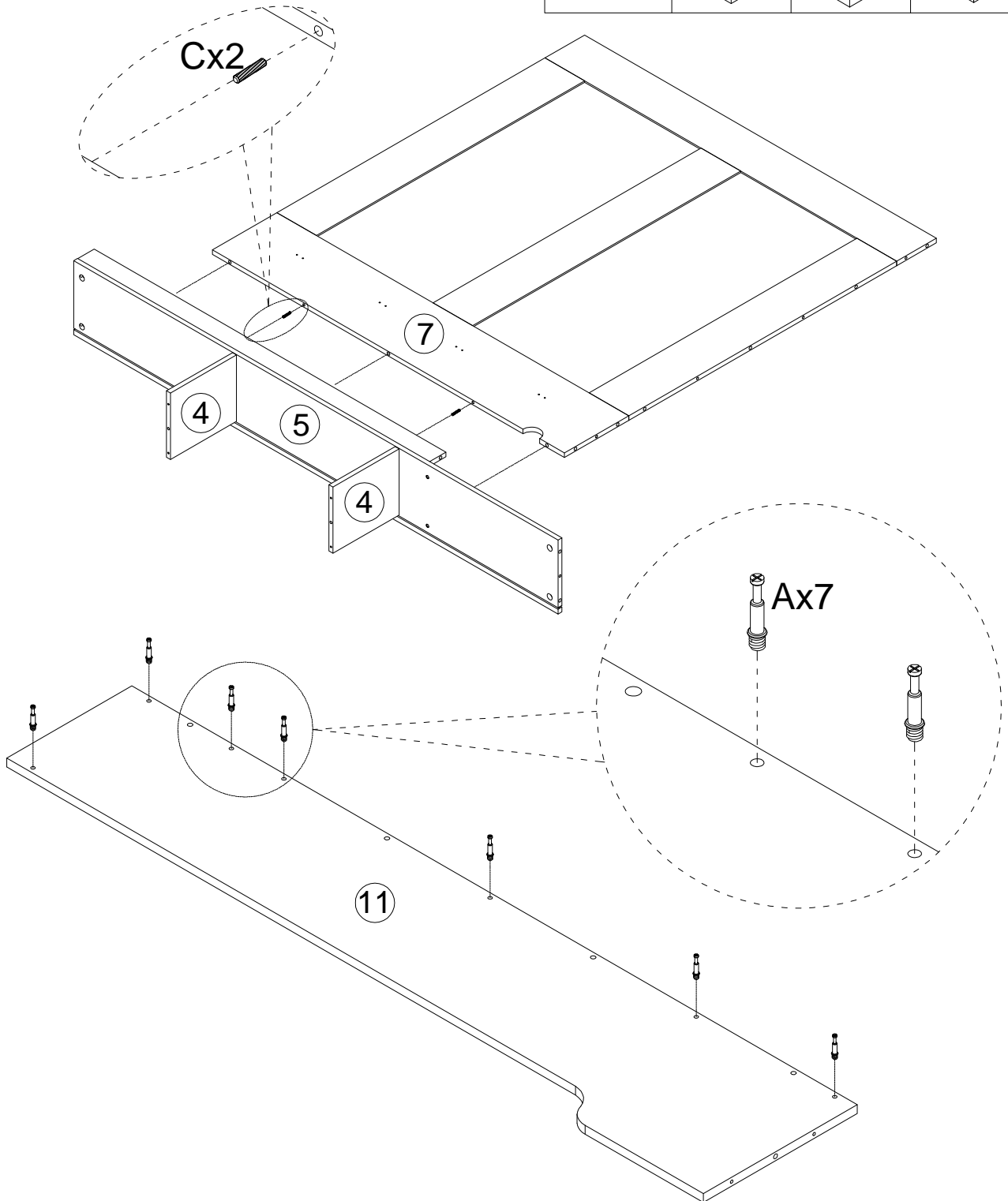
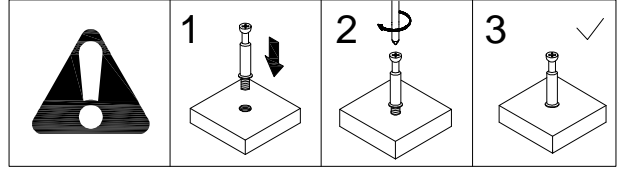
Step 5

			
A	7PCS	C	2PCS



Assemble

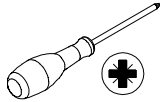

Step 6

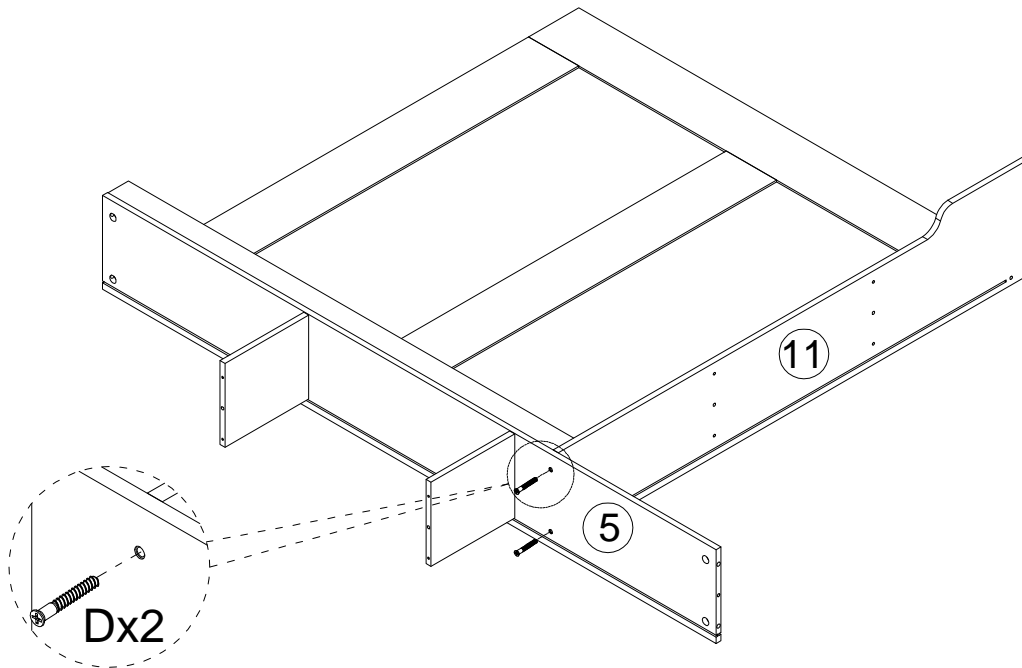
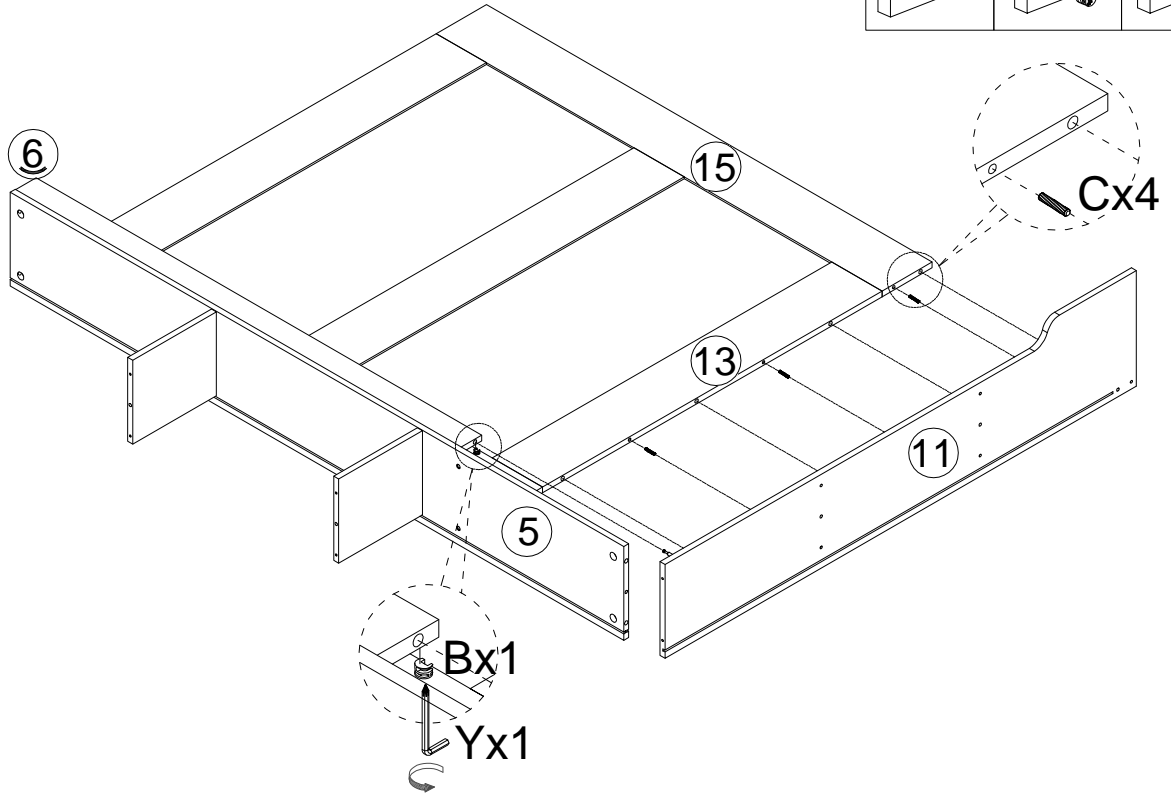
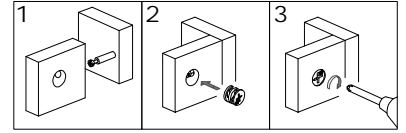
								
B	1PC	C	4PCS	D	2PCS	Y	1PC	



Assemble

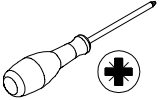

Step 7

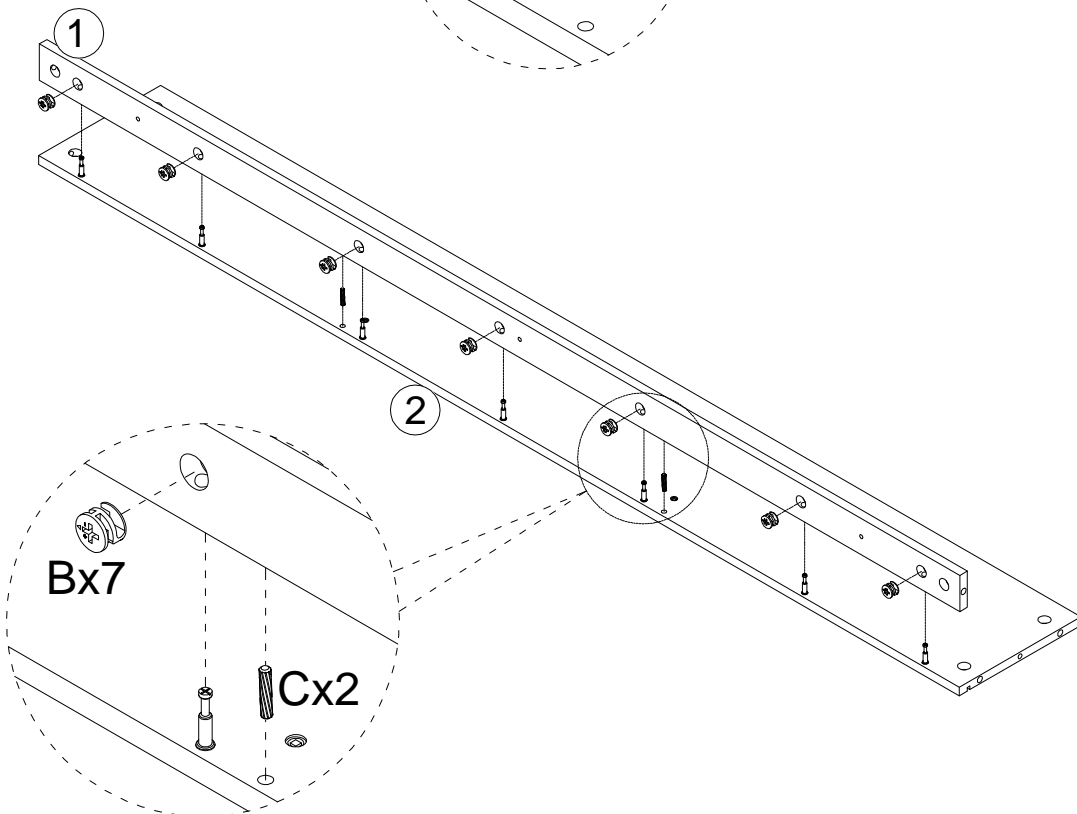
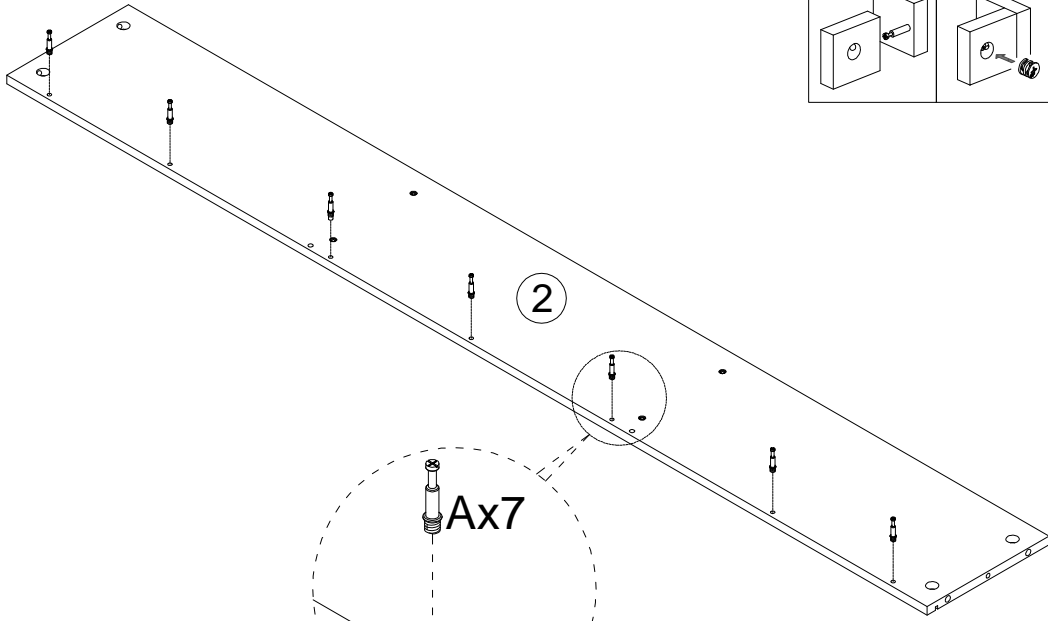
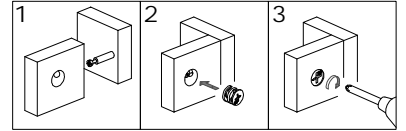
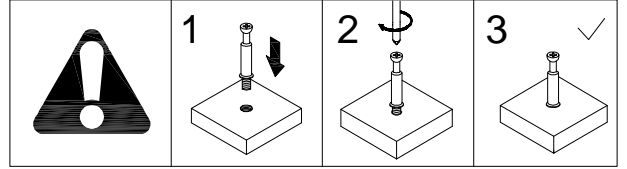
			
A	7PCS	B	7PCS
		C	2PCS



Assemble



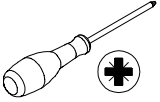

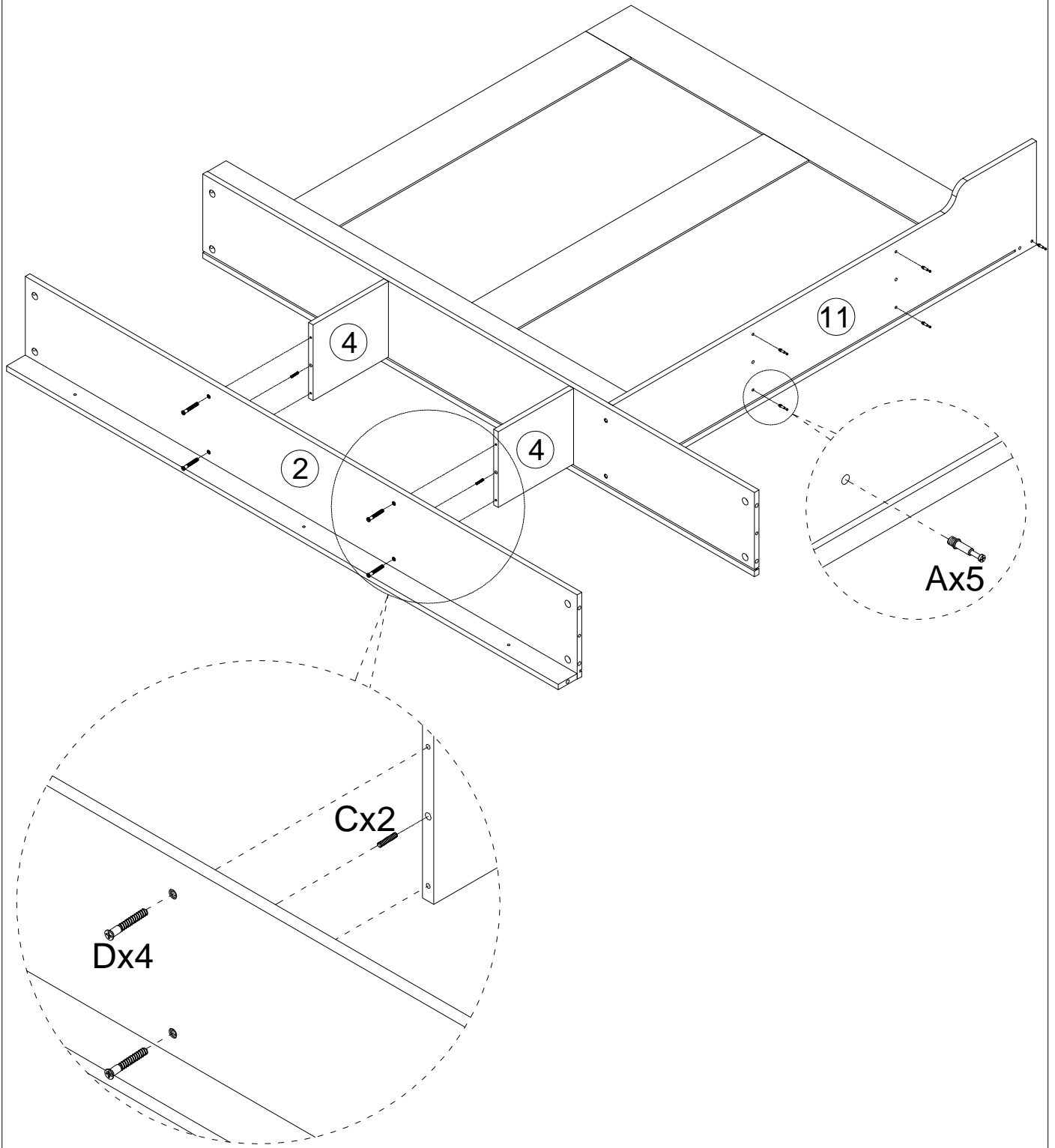
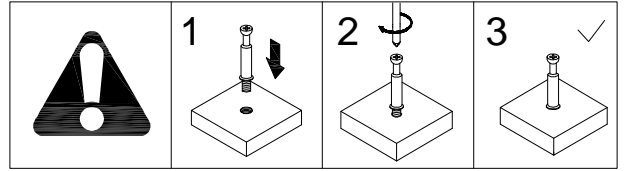
Step 8

					
A	5PCS	C	2PCS	D	4PCS

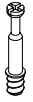

Assemble

Step 9

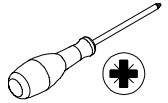
								
A	12PCS	B	5PCS	C	6PCS	Y	1PC	

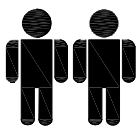
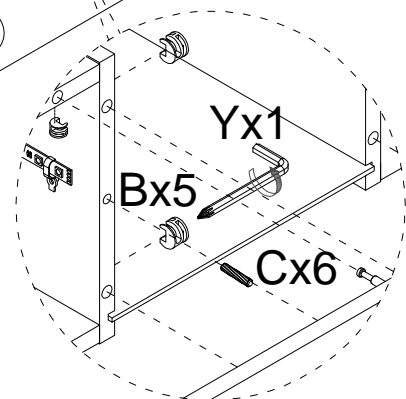
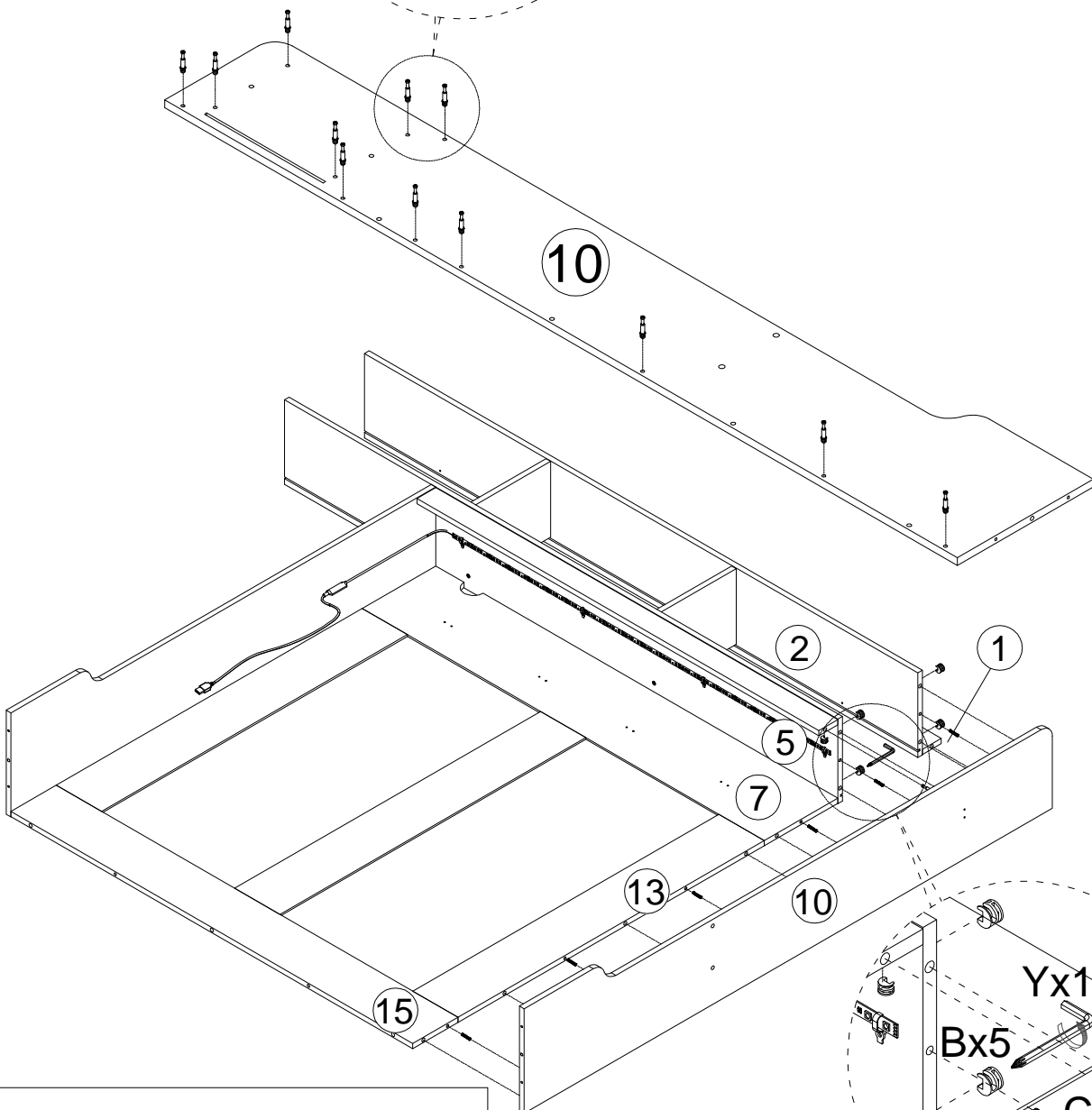
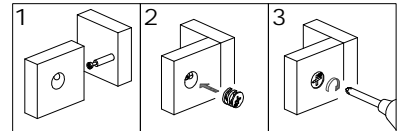
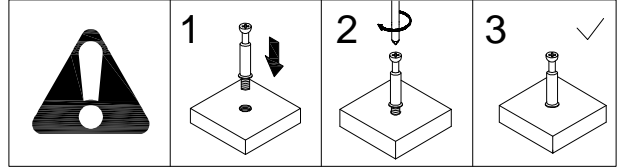
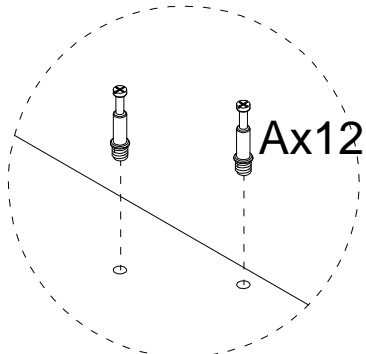

Two people are required to assemble and move this model.

Assemble

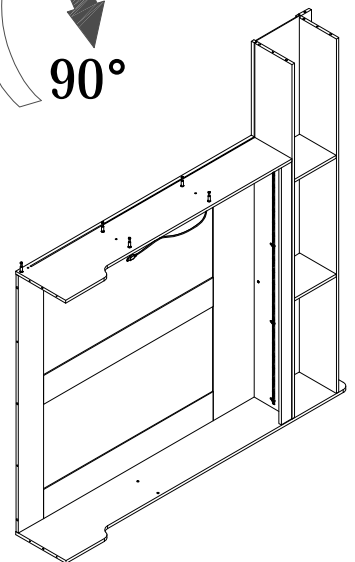
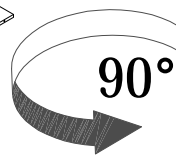
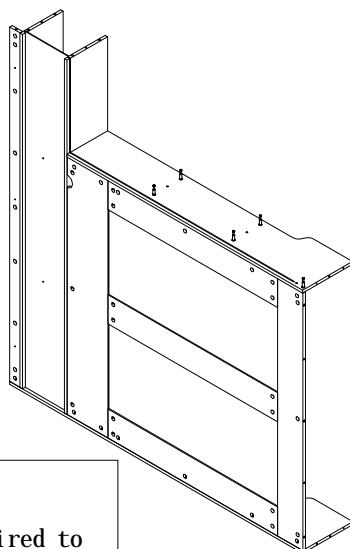
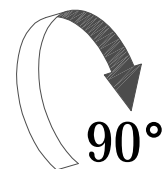
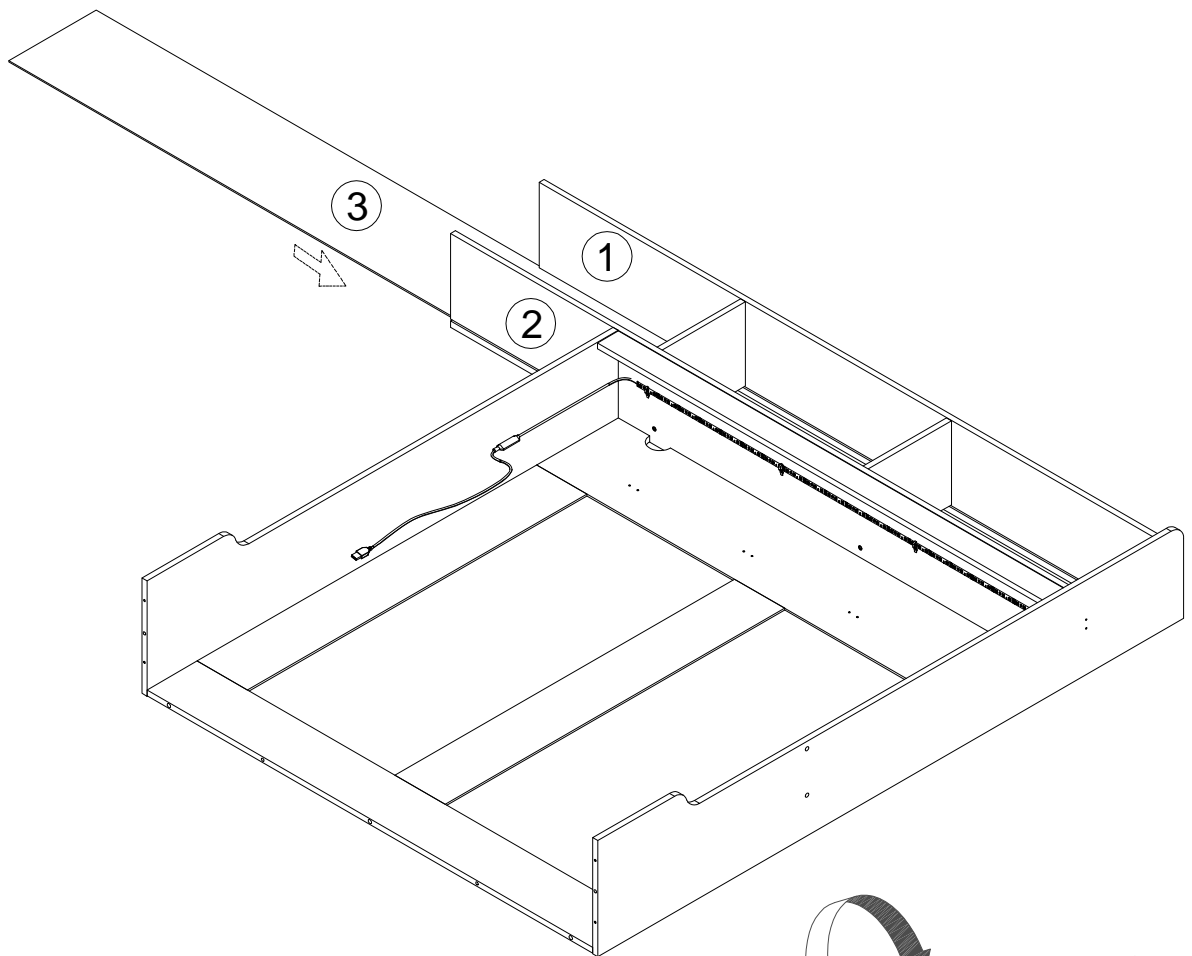

Step 10



Two people are required to assemble and move this model.

Assemble

Step 11

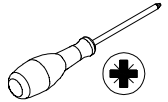

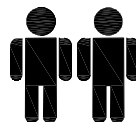
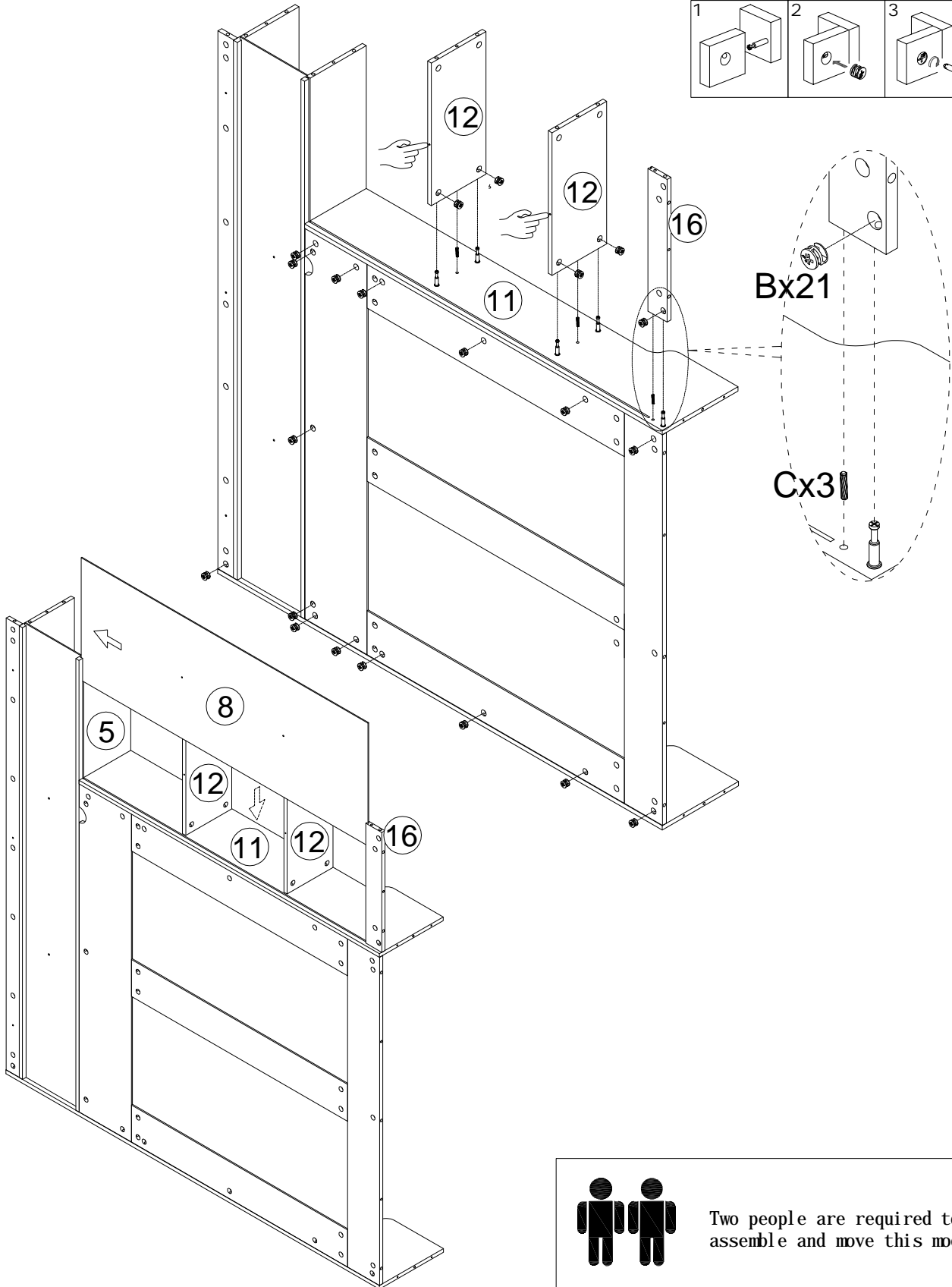
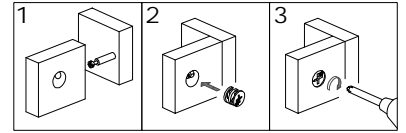

			
B	21PCS	C	3PCS

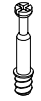

Two people are required to assemble and move this model.

Assemble

Step 12

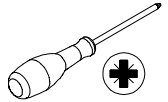

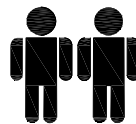
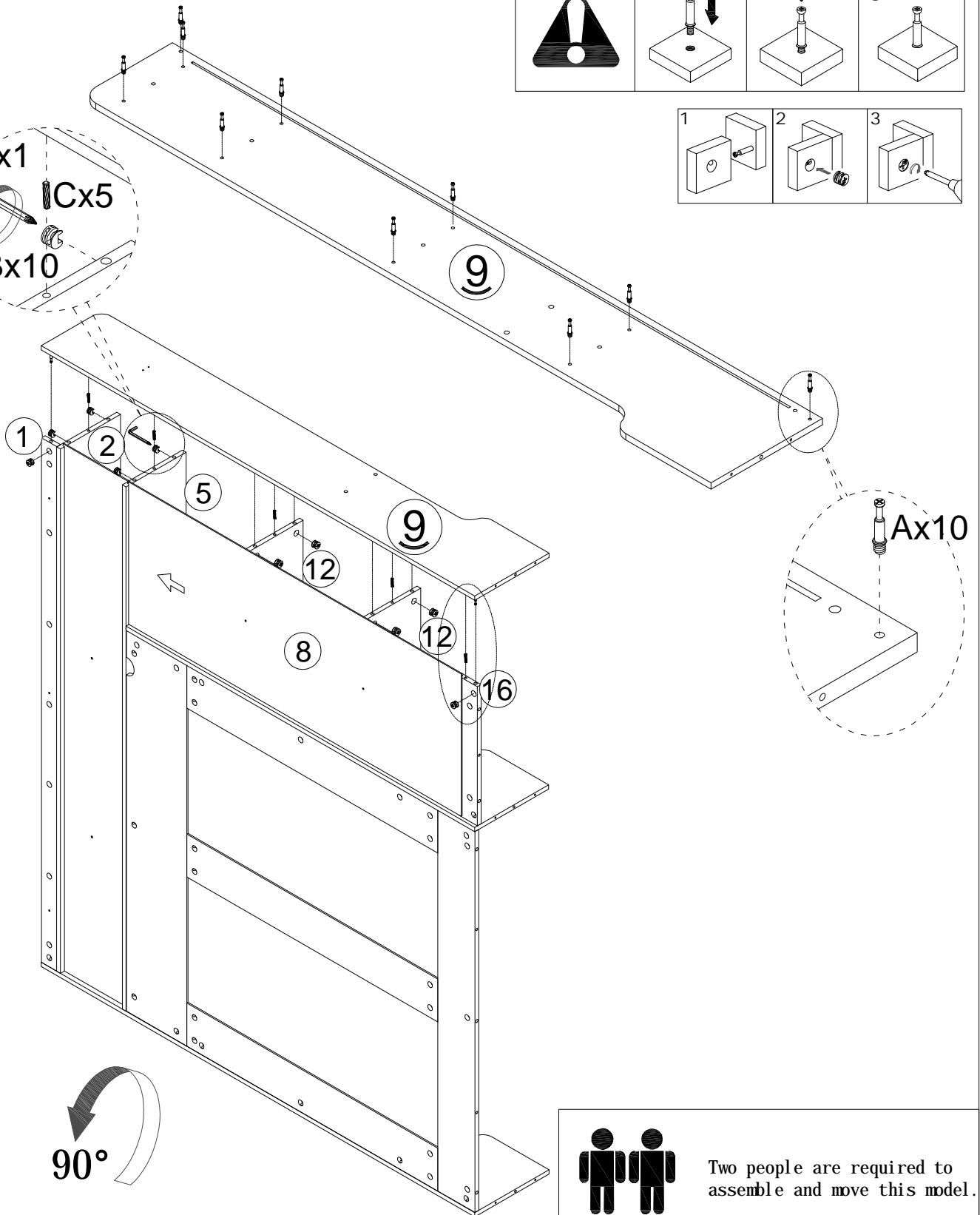
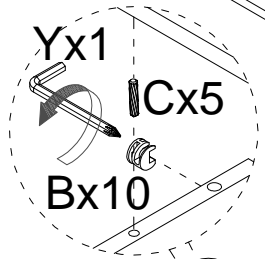
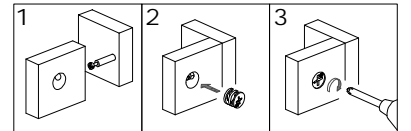
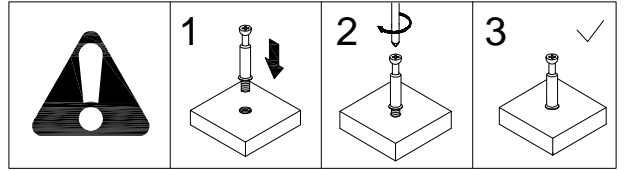
								
A	10PCS	B	10PCS	C	5PCS	Y	1PC	



Two people are required to assemble and move this model.

Assemble

Step 13

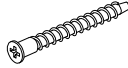
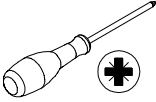
			
A	5PCS	C	6PCS
D	6PCS		

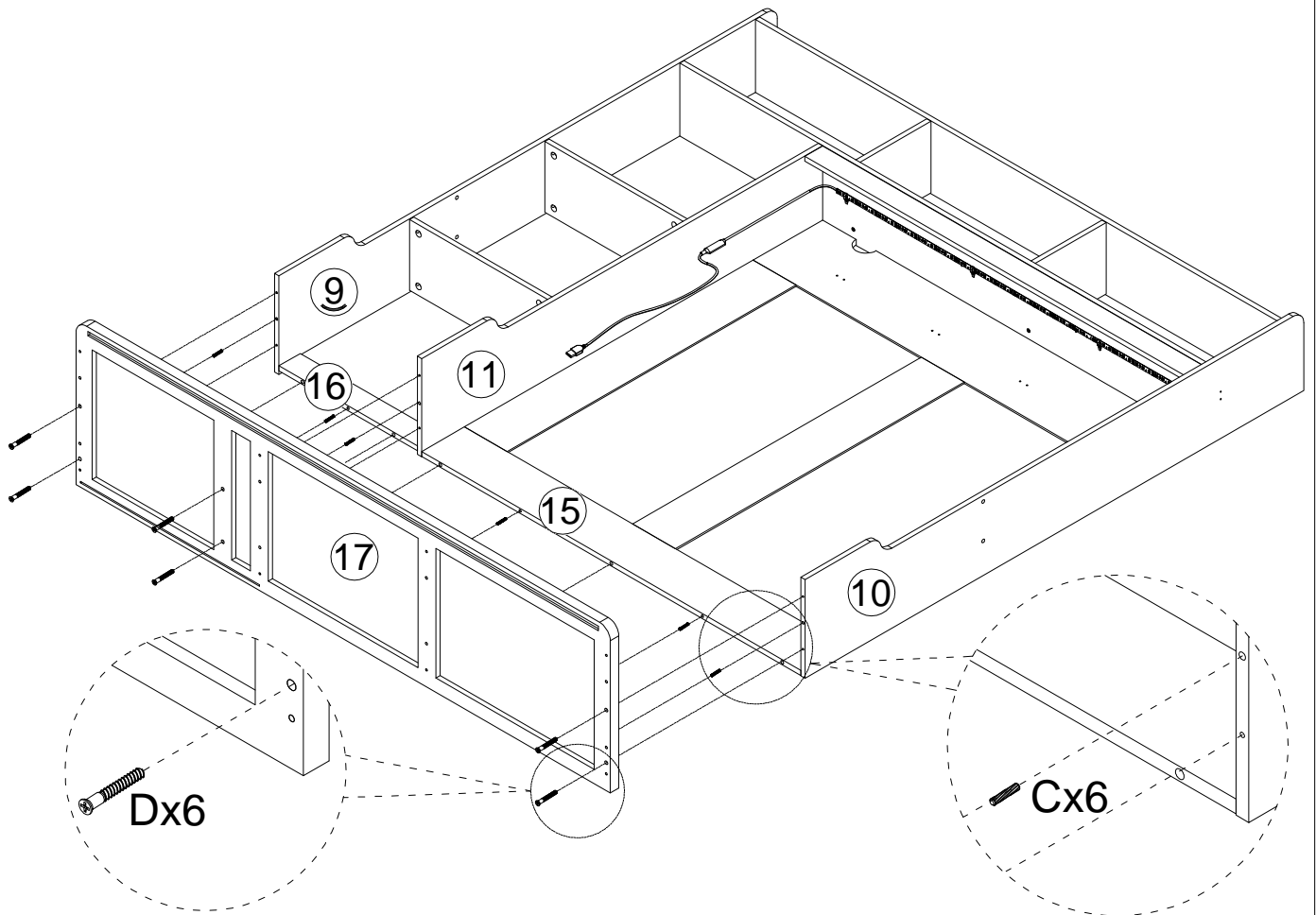
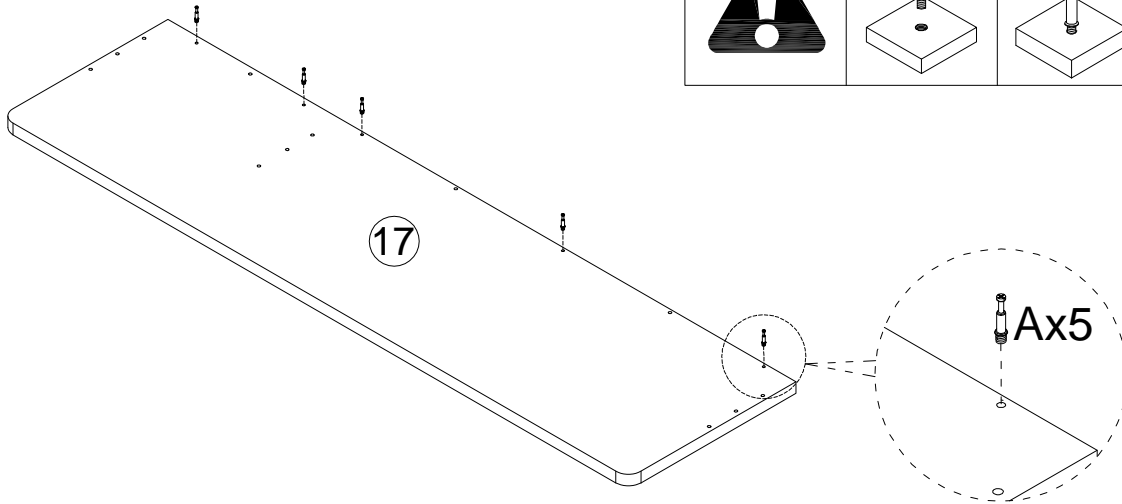
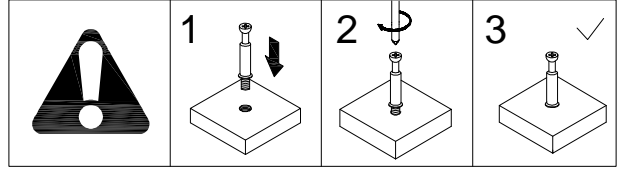

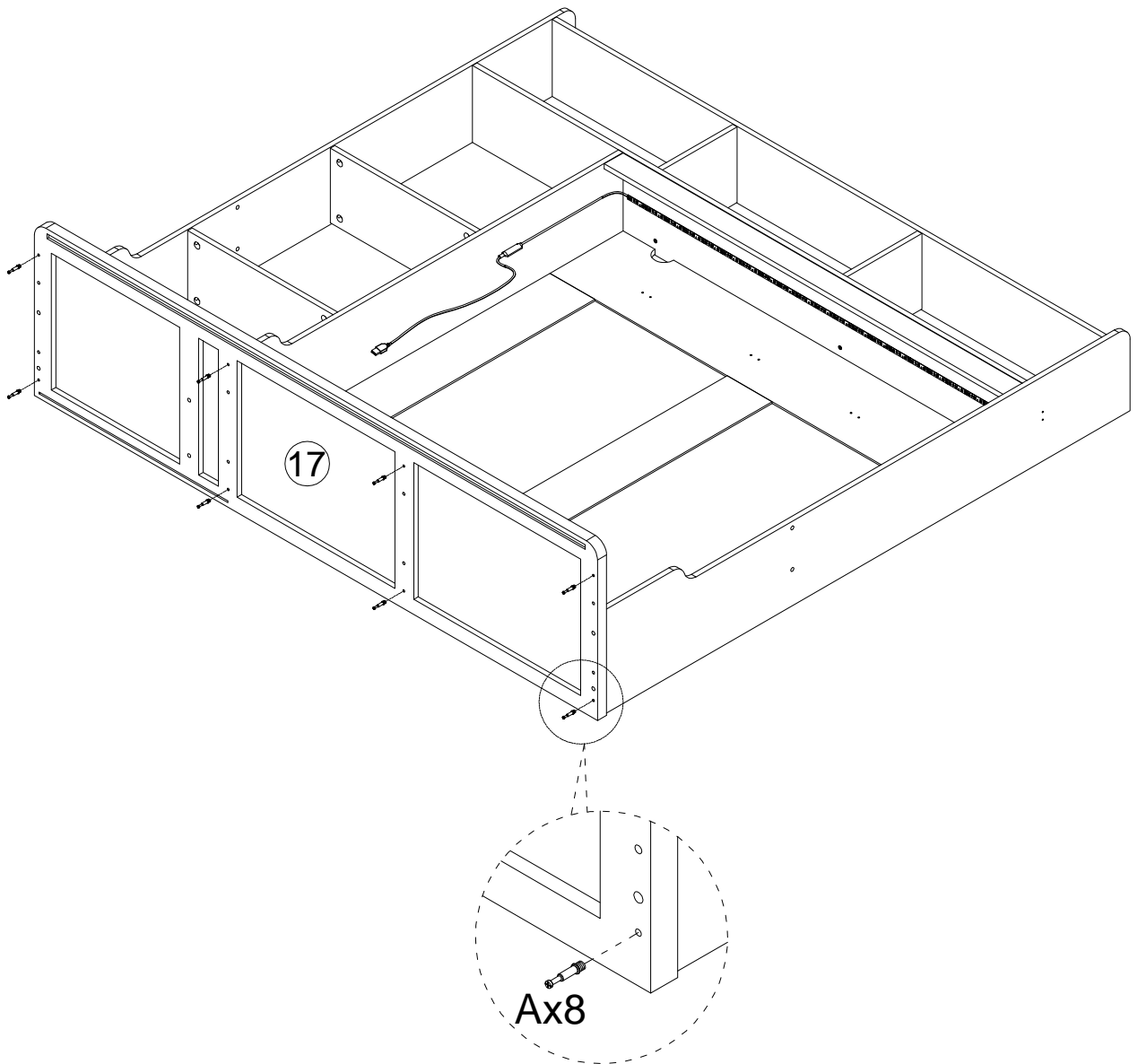
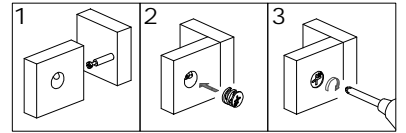
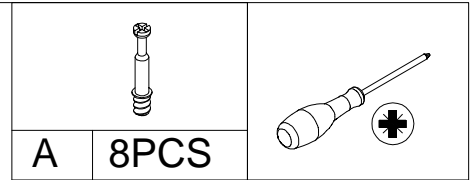

Assemble

Step 14



Assemble

Step 15

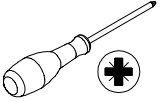
			
4PCS	B 2PCS	C 1PC	

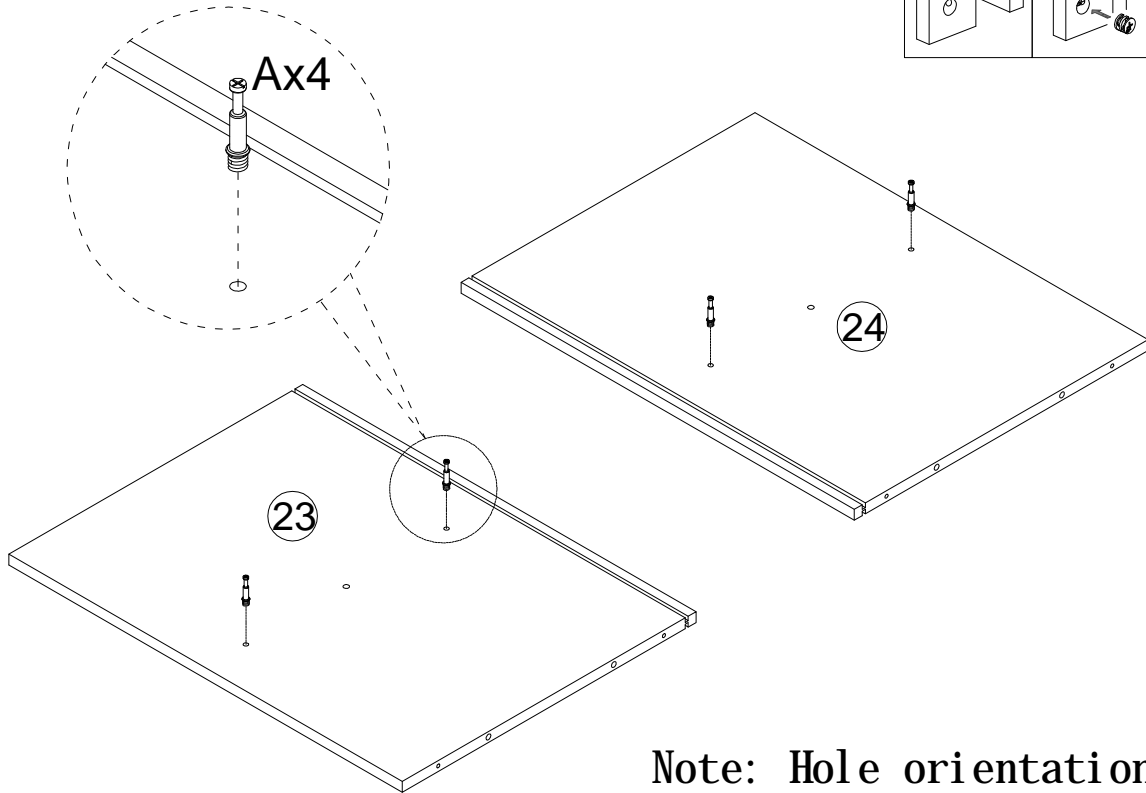
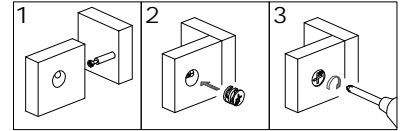

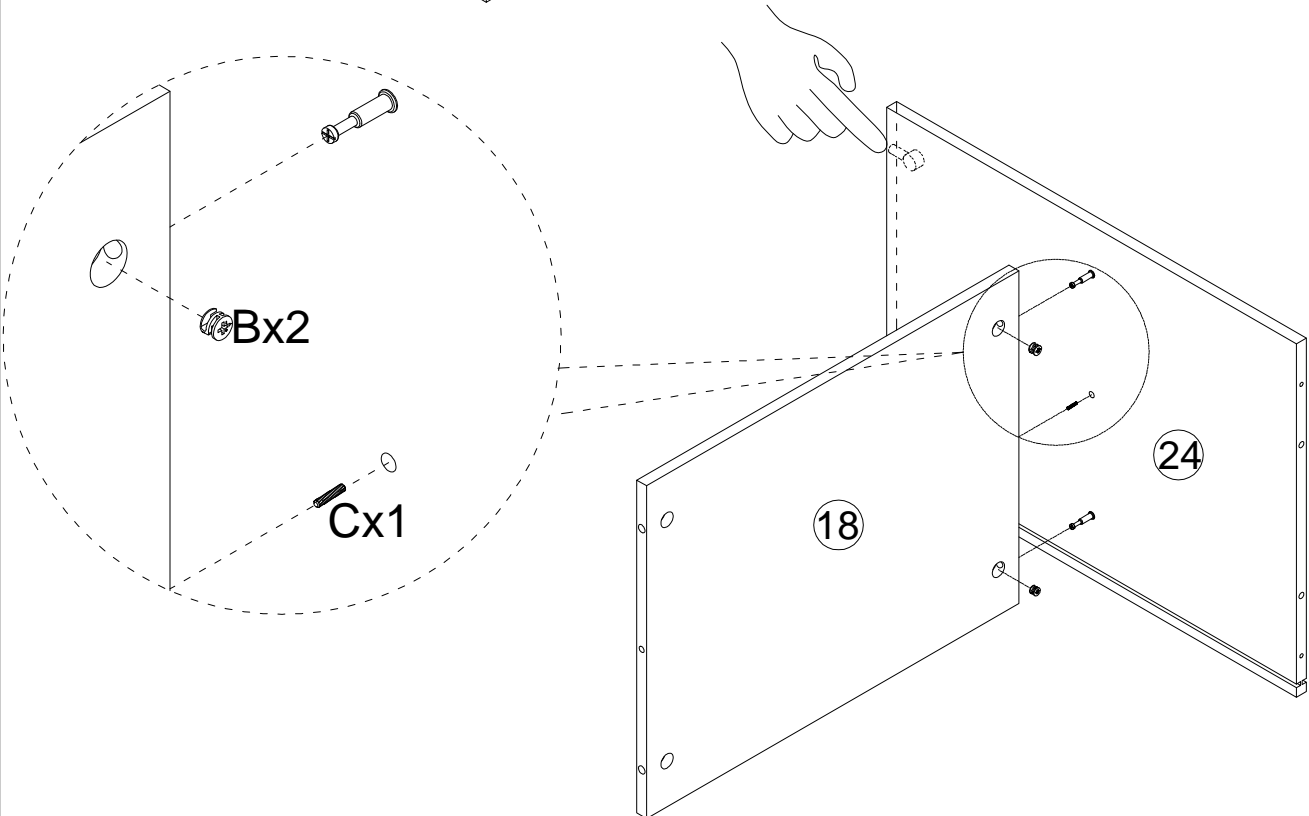

Note: Hole orientation



Assemble

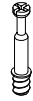

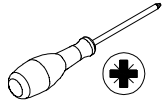
Step 16

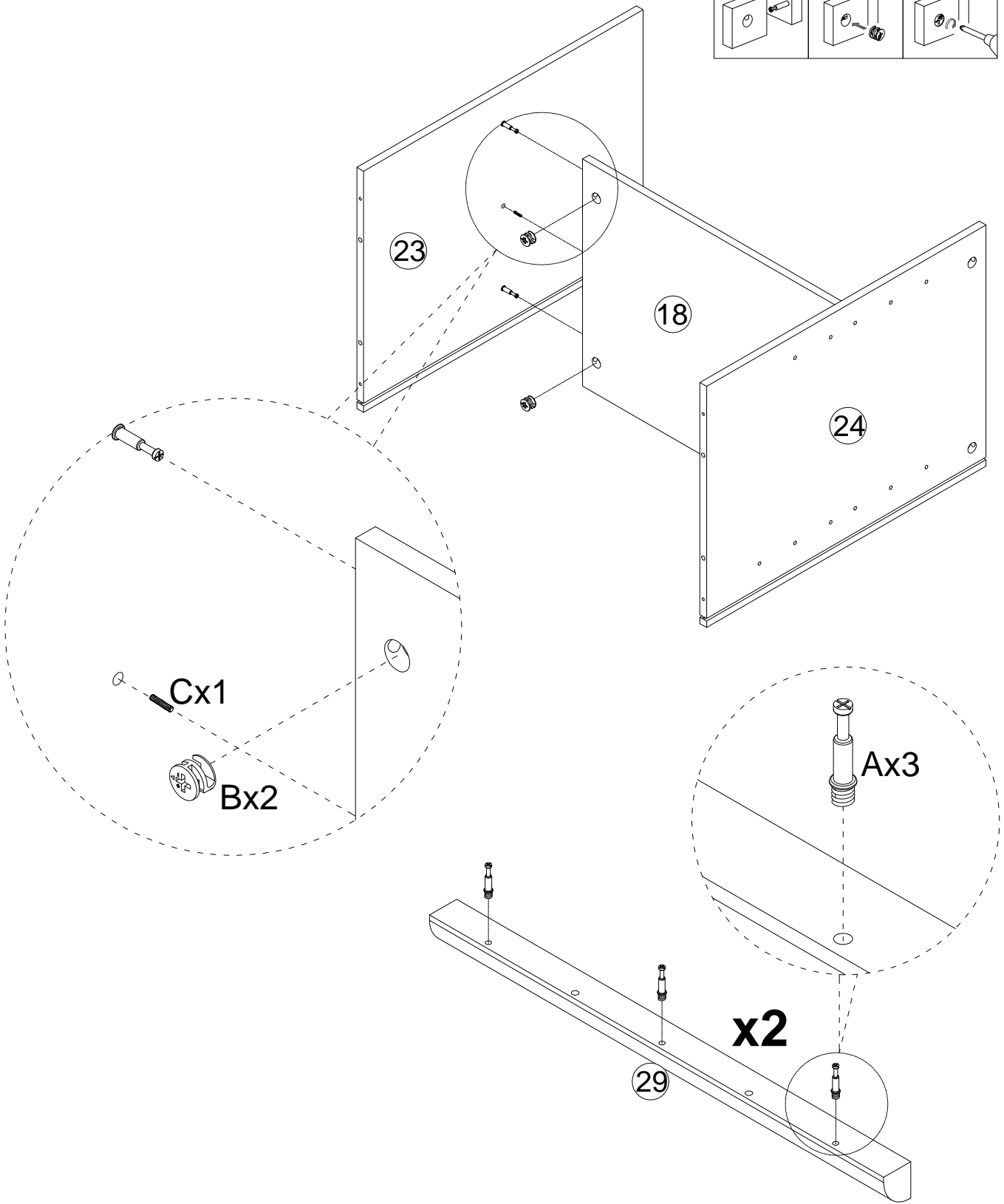
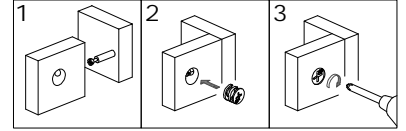
			
A 6PCS	B 2PCS	C 1PC	



Assemble

Step 17

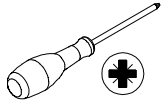
			
B	14PCS	C	12PCS

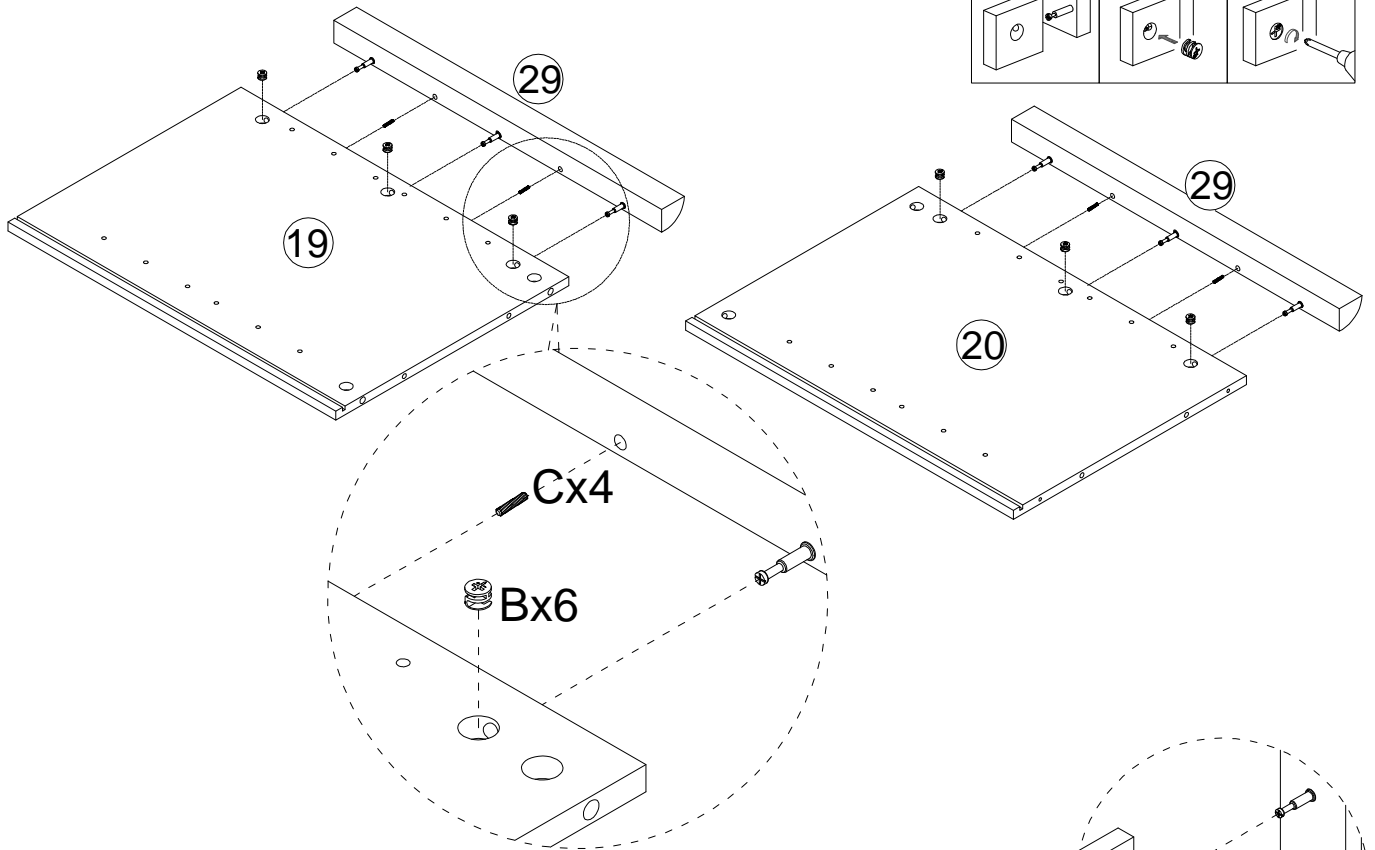
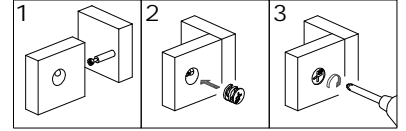

Two people are required to assemble and move this model.

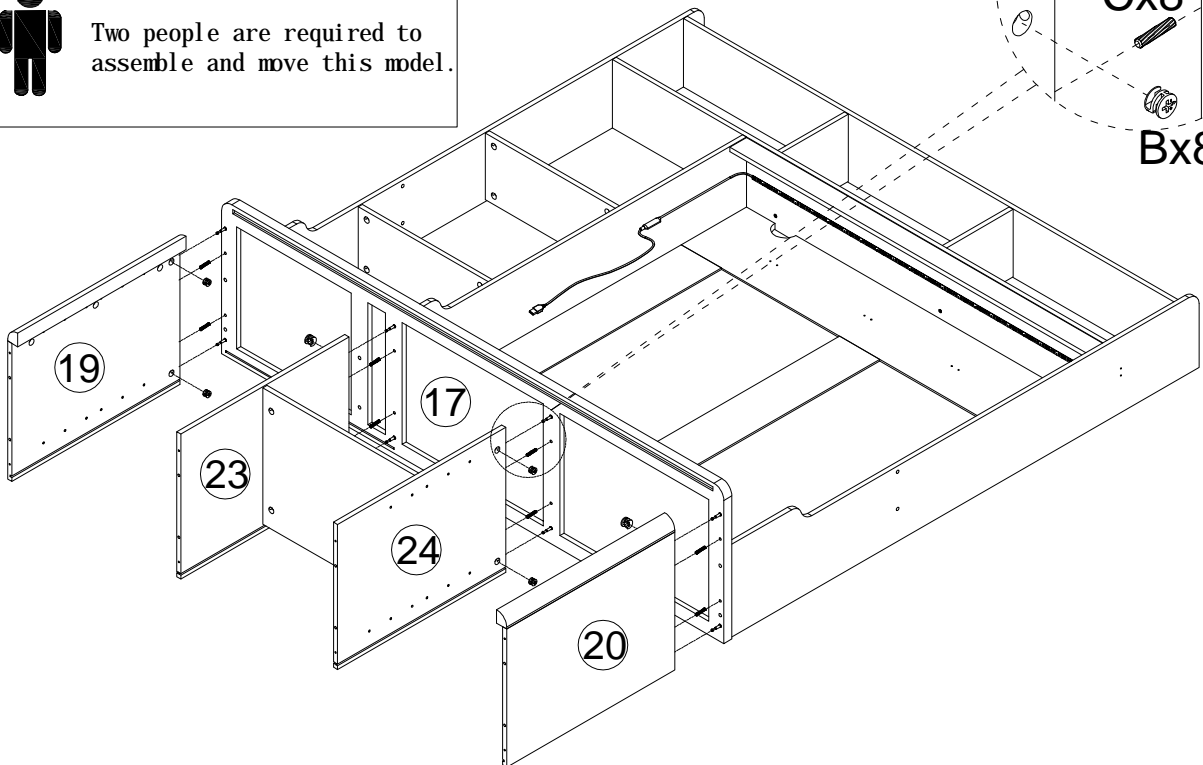
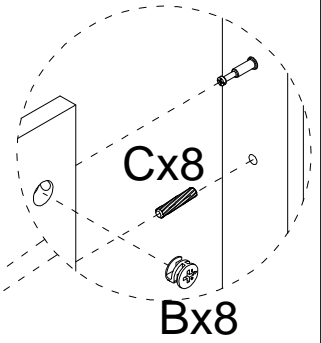

Assemble

Step 18

	
X	8PCS

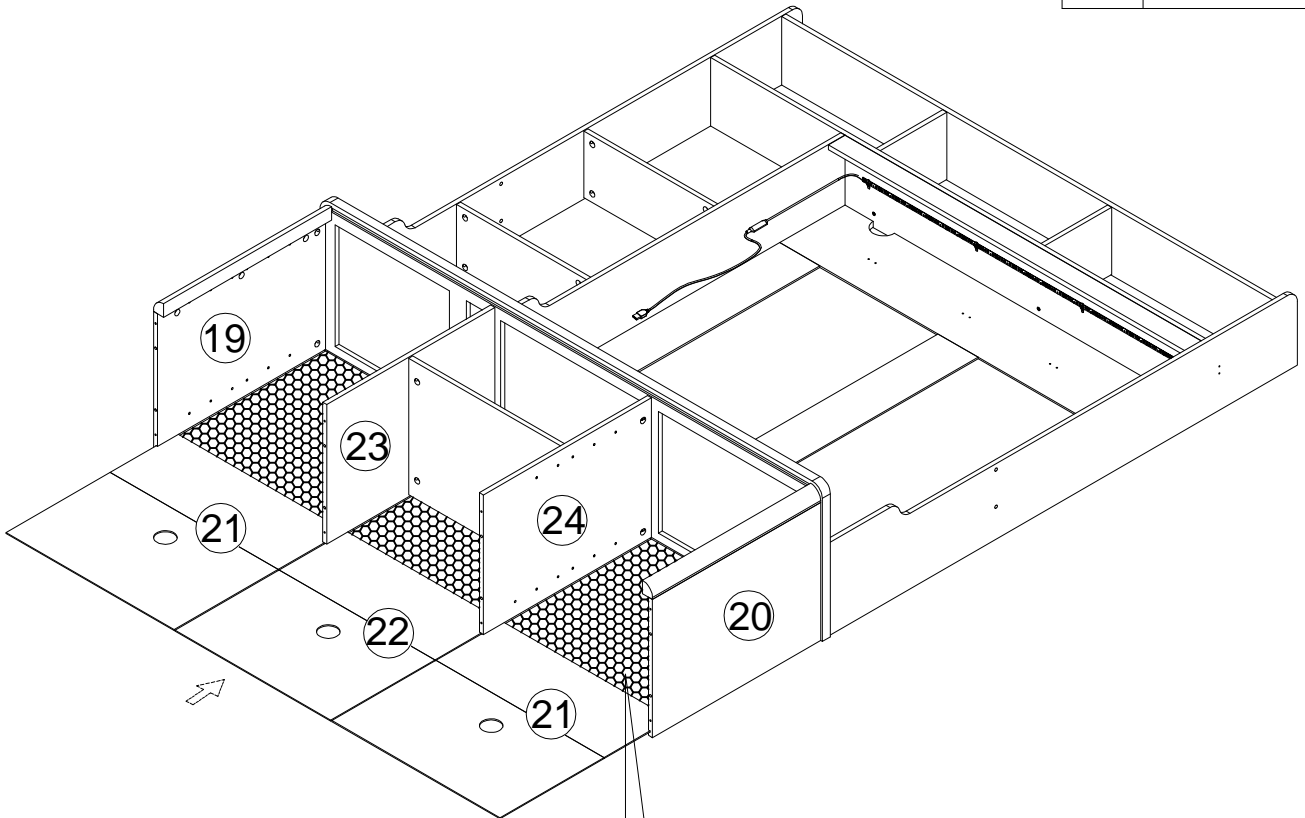

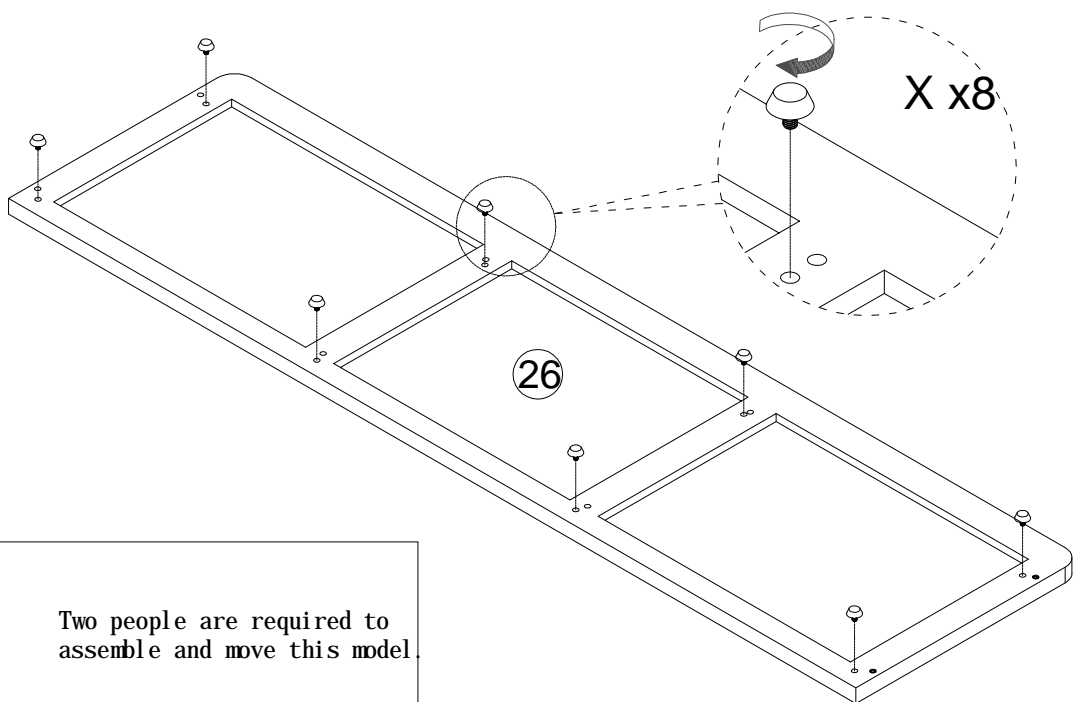

Note: Before inserting the back panel into the panel slot, place a 15mm mounting pad underneath as shown in the diagram.



Two people are required to assemble and move this model.

Assemble

Step 19

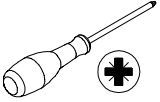

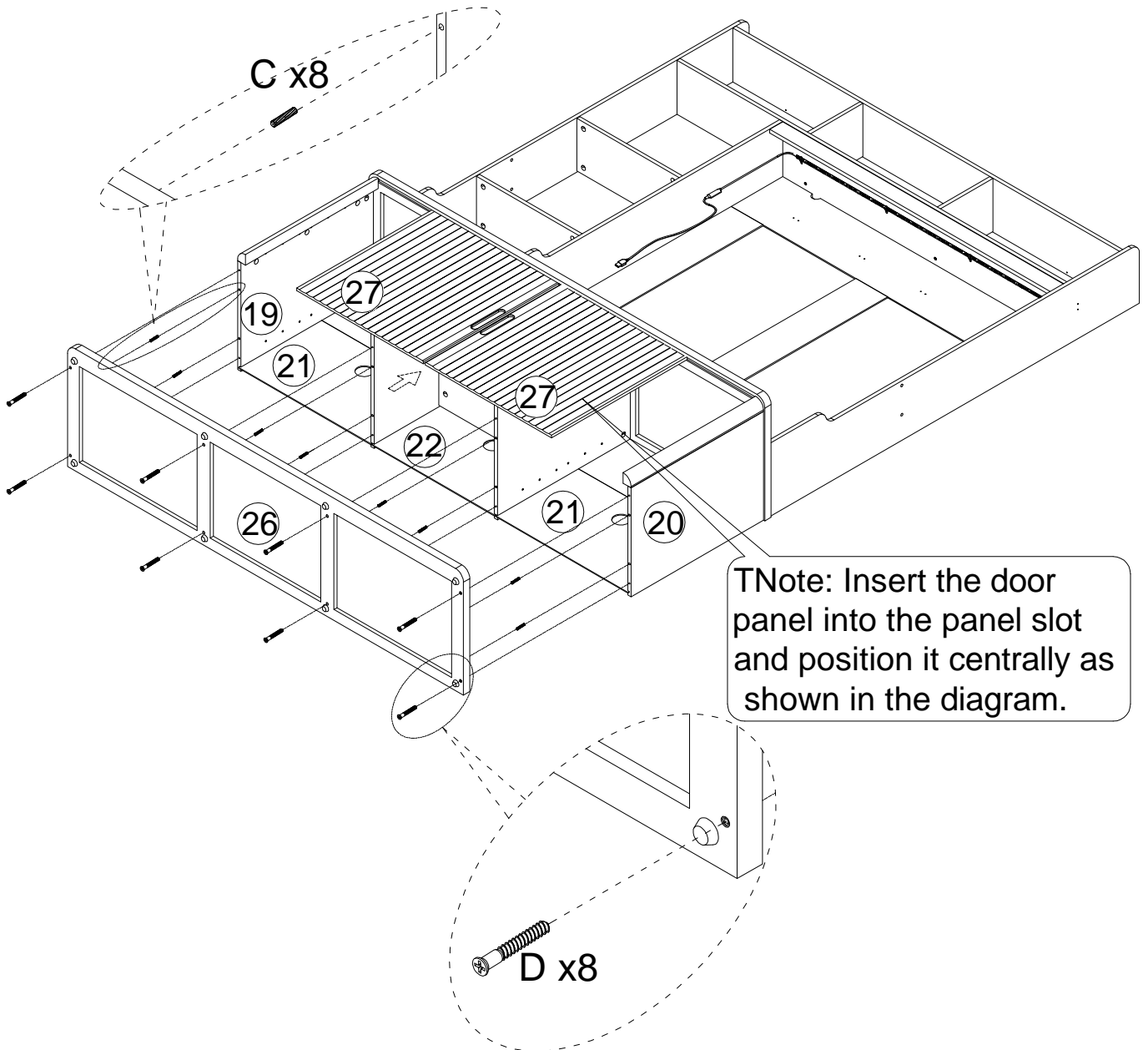



			
C	8PCS	D	8PCS



Two people are required to assemble and move this model.

Assemble

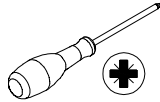
Step 20

								
F	4PCS	N	6PCS	P	12PCS	V	2PCS	
								
W	6PCS	Y	1PC					

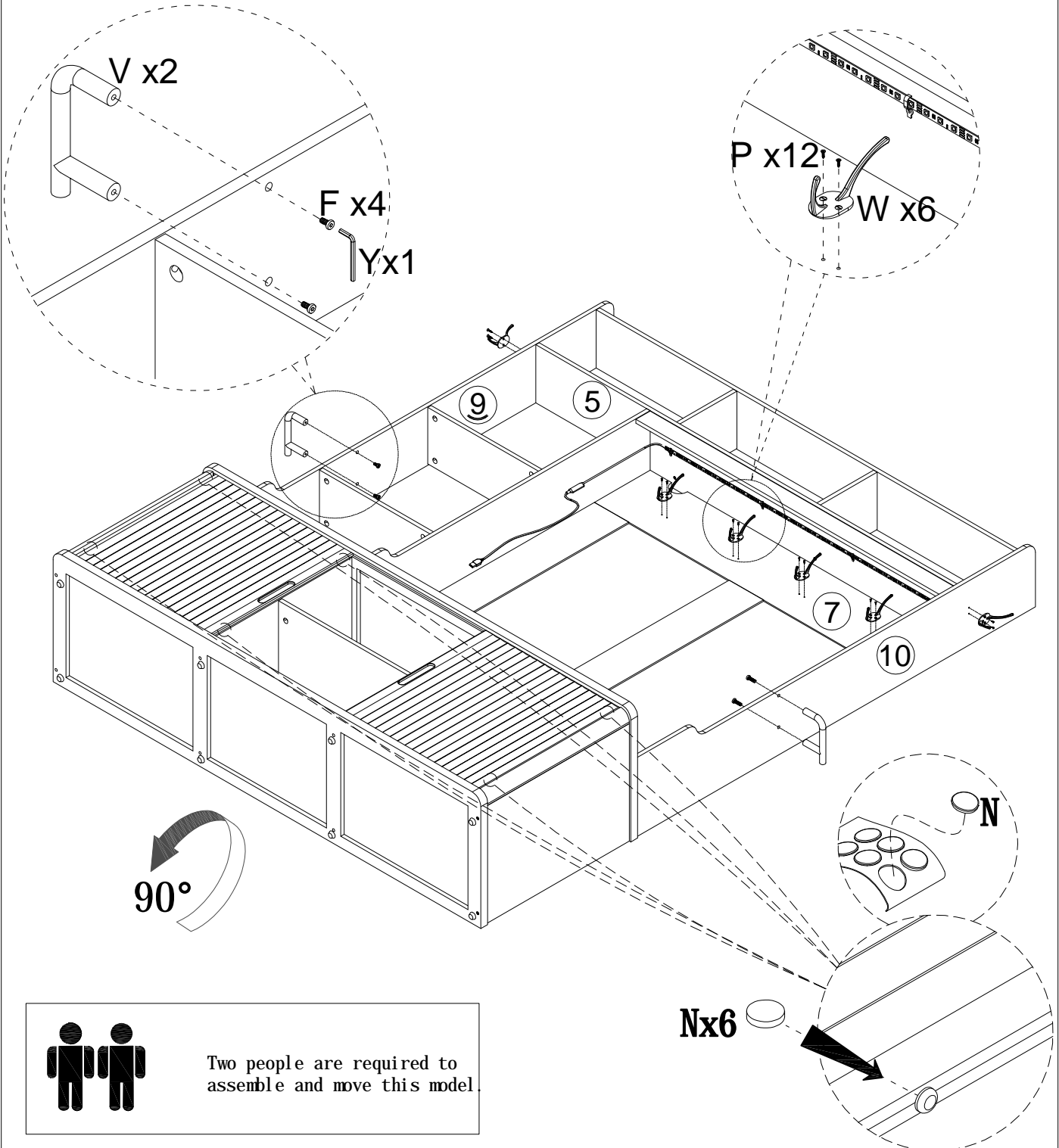

Two people are required to assemble and move this model.

Assemble

Step 21

	
E	8PCS

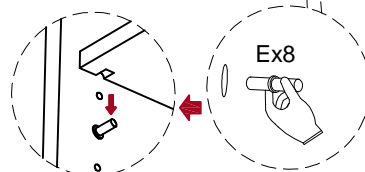
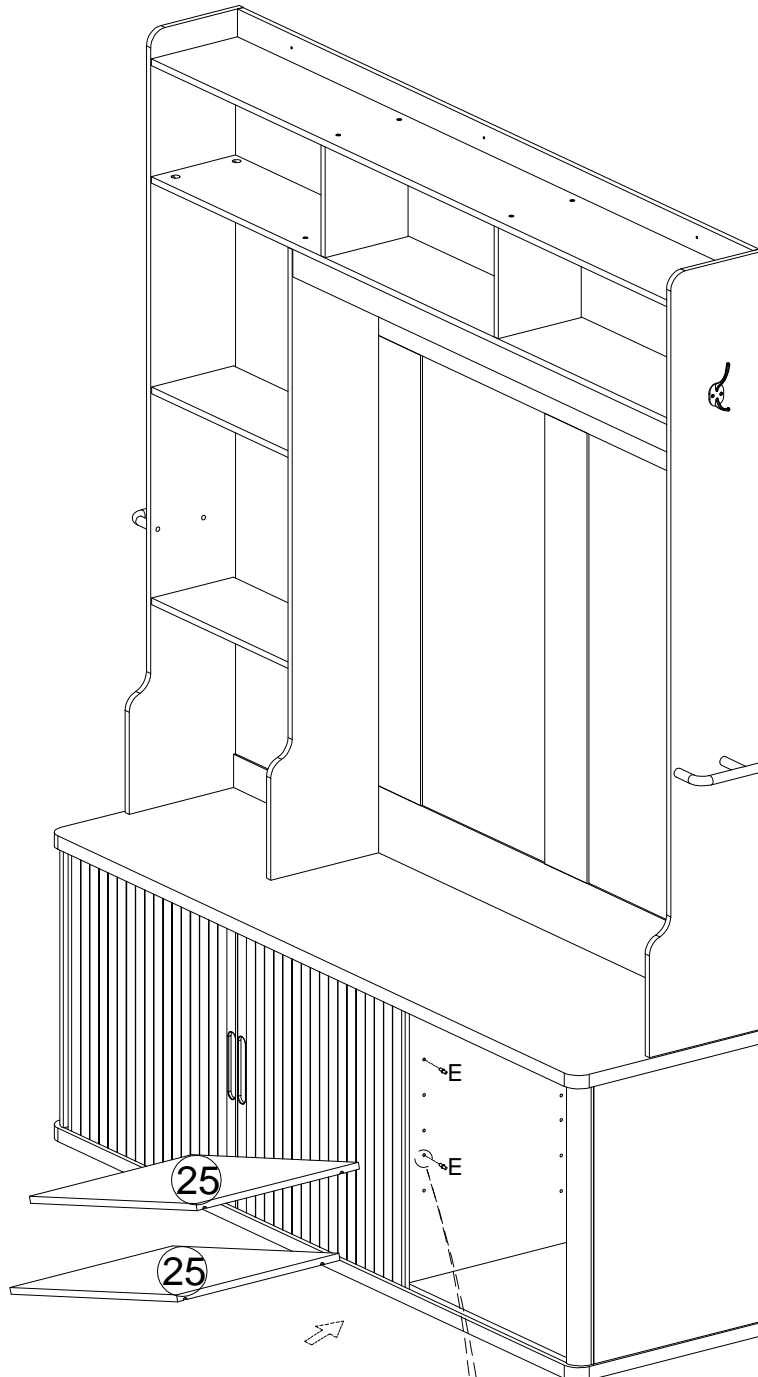





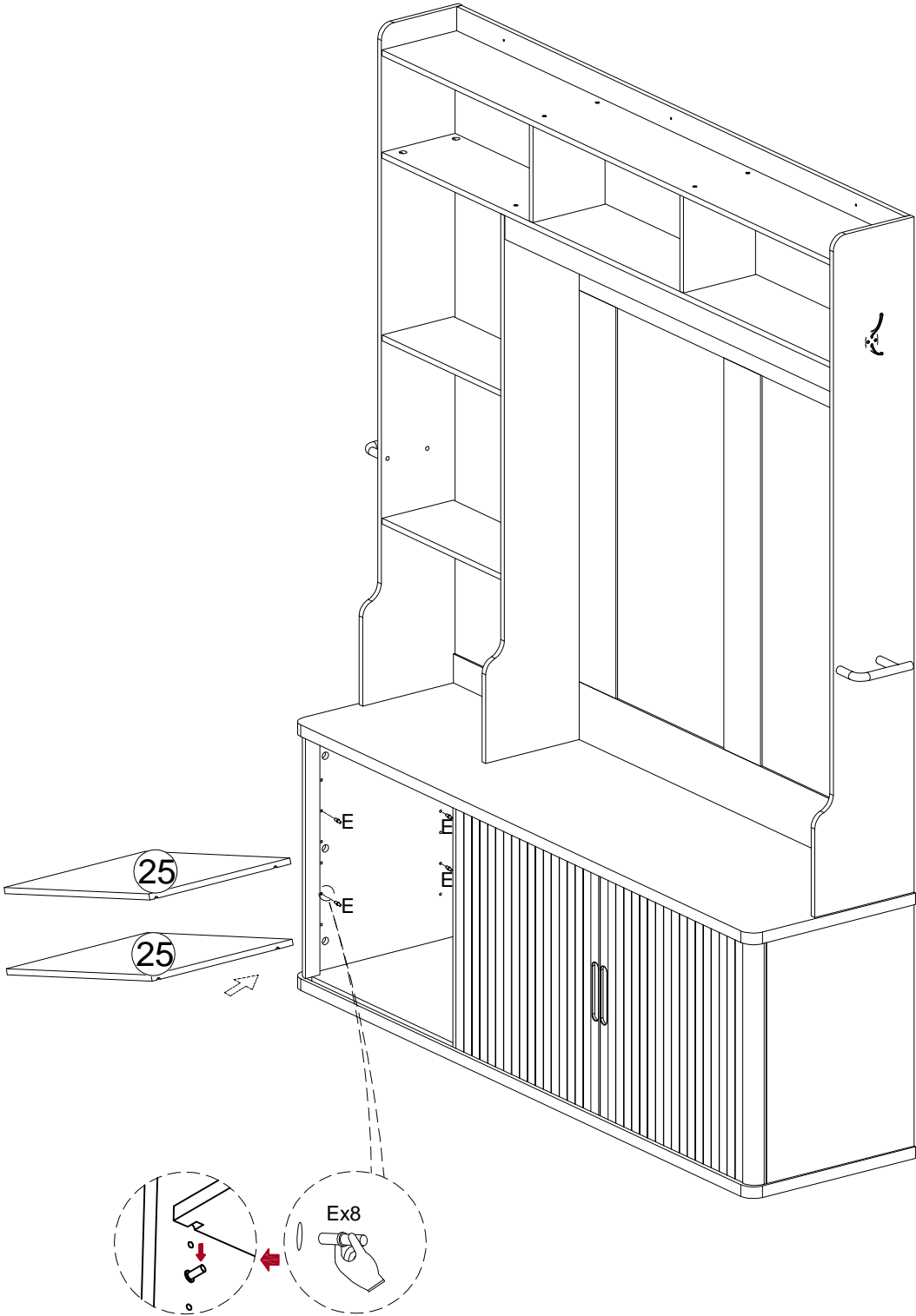

Step 22

	
E	8PCS



Assemble

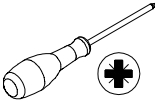

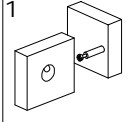
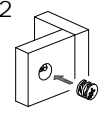
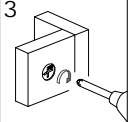
Step 23

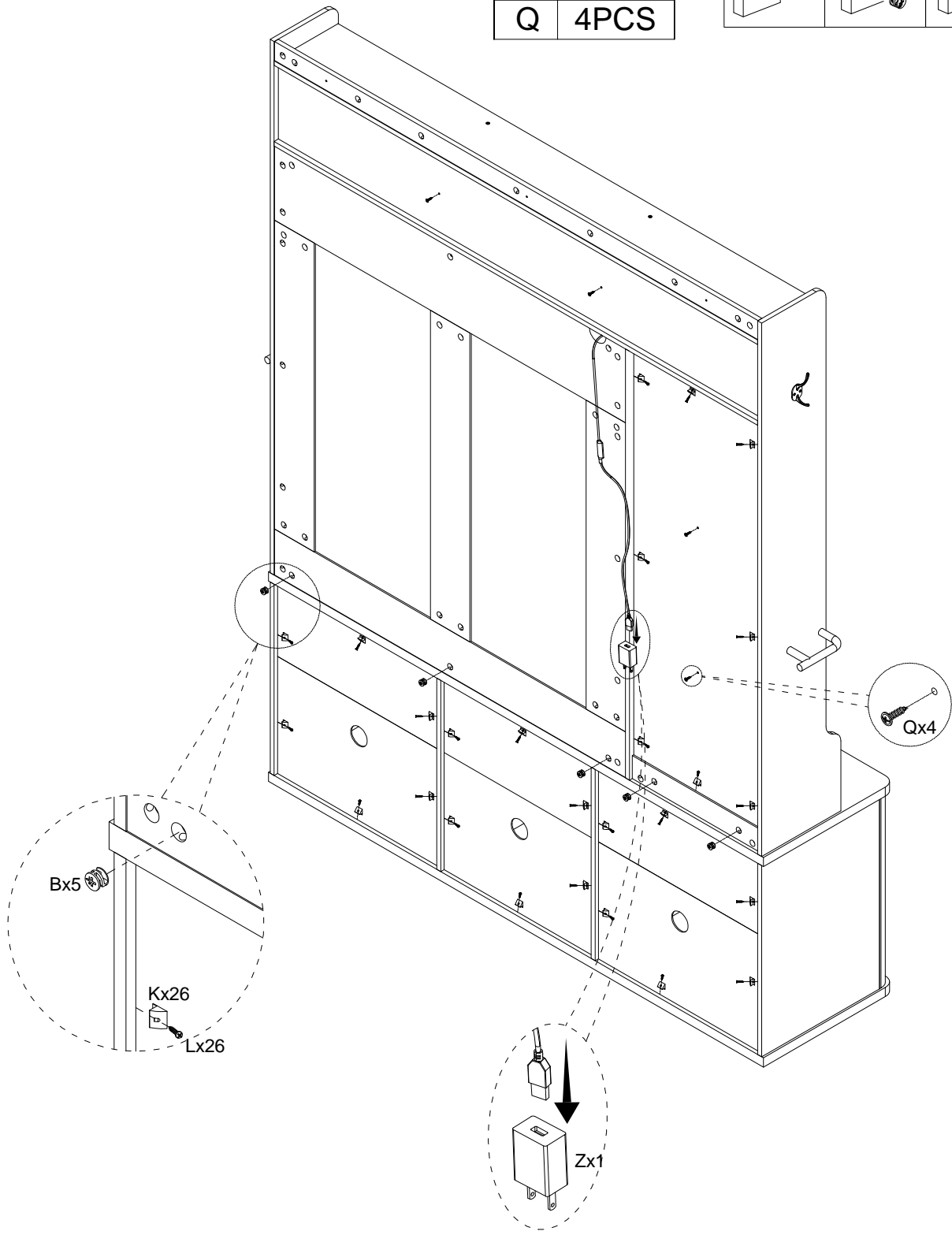
				
B 5PCS	K 26PCS	L 26PCS	Z 1PC	
				
		Q 4PCS	  	

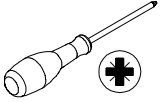

Assemble

Step 24

		 
M	84PCS	

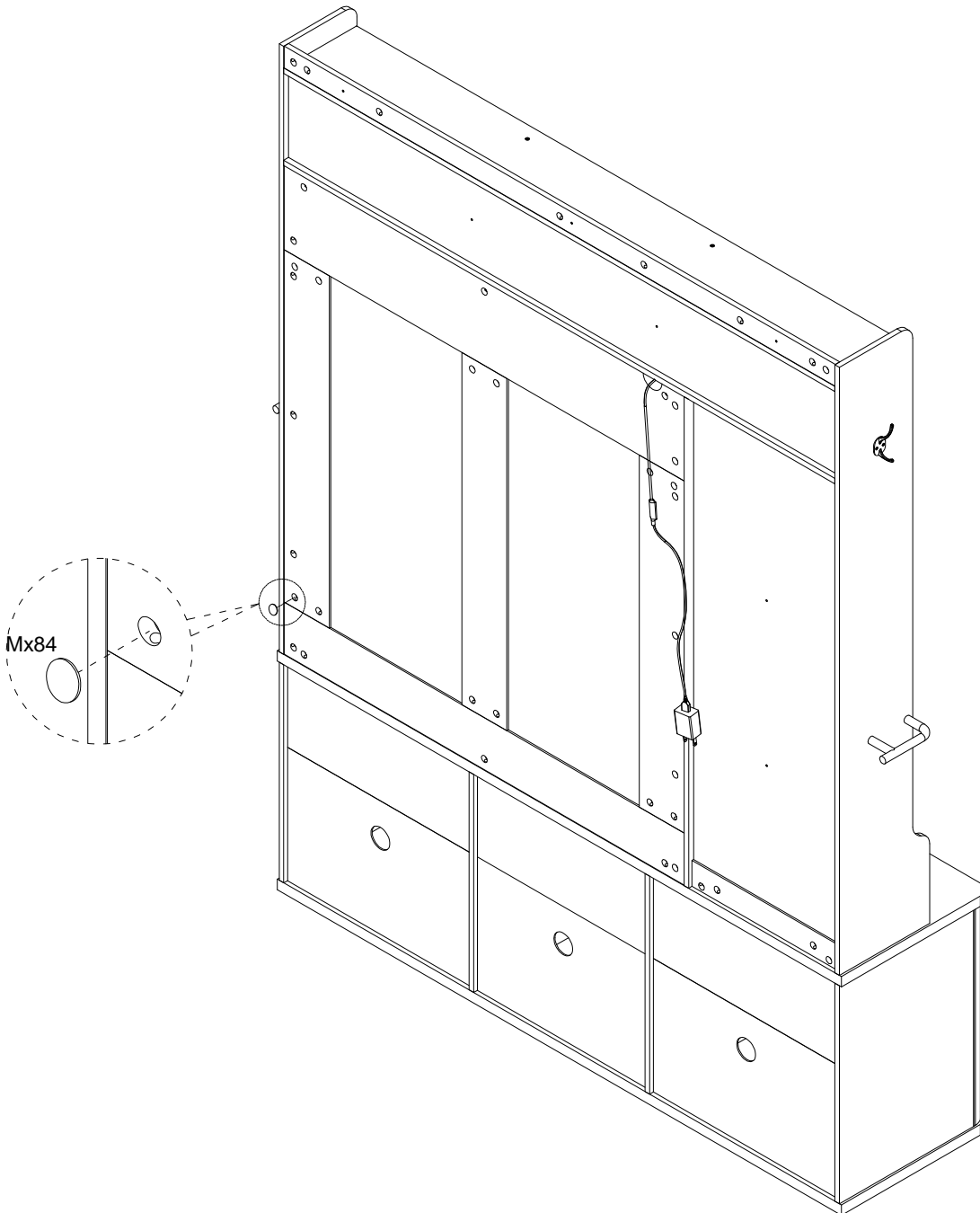

Assemble

Step 25

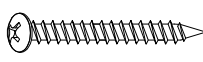
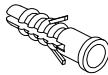
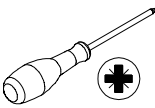
			
G 3PCS	H 3PCS	J 3PCS	

⚠ Warning: If you overturn the furniture, it may cause serious or fatal crushing injuries.

We have a wall connection device attached, please use it to hold the furniture following these instructions.

1. Mark the corresponding hole positions where you want to place the furniture;
2. Use a impact drill to drill holes and pay attention to avoid wires and water pipes;
3. Knock the expansion pipes into the wall holes;
4. Place the furniture in the corresponding position and tighten the wall connection device with screws.

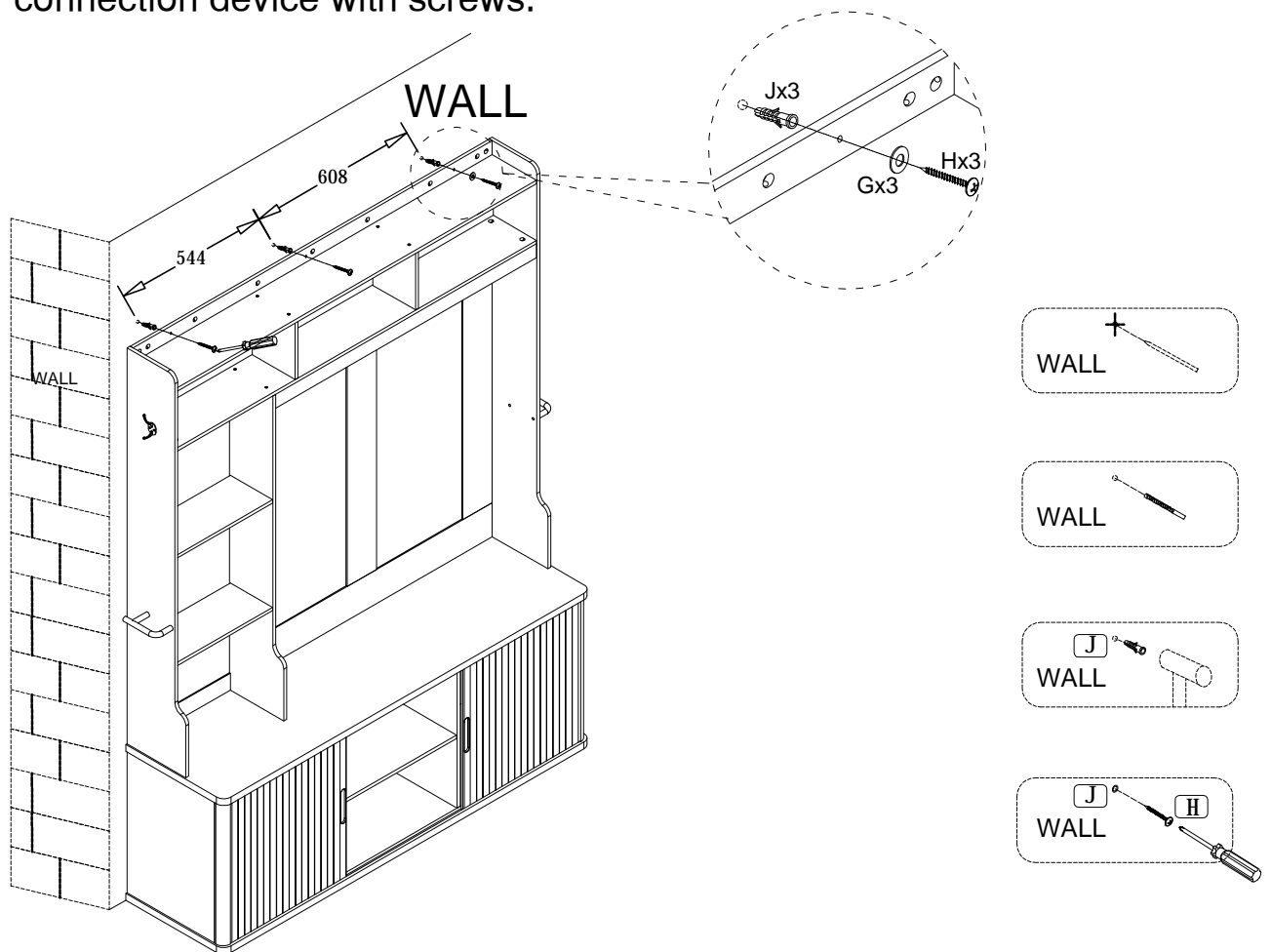

Installation Completed

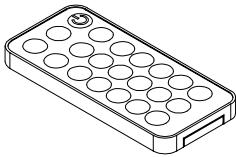

The product contains replaceable batteries.

Battery type(CR2032)

Nominal voltage: 3~5V

-
- a) The statement "Ensure the batteries are installed correctly according to polarity (+ and -)."
 - b) The statement "Do not mix old and new batteries, different brands or types of batteries, such as alkaline, carbon-zinc, or rechargeable batteries."
 - c) The statement "Remove and immediately recycle or dispose of batteries from equipment not used for an extended period of time according to local regulations."
 - d) The statement "Always completely secure the battery compartment, If the battery compartment does not close securely, stop using the product, remove the batteries, and keep them away from children."