

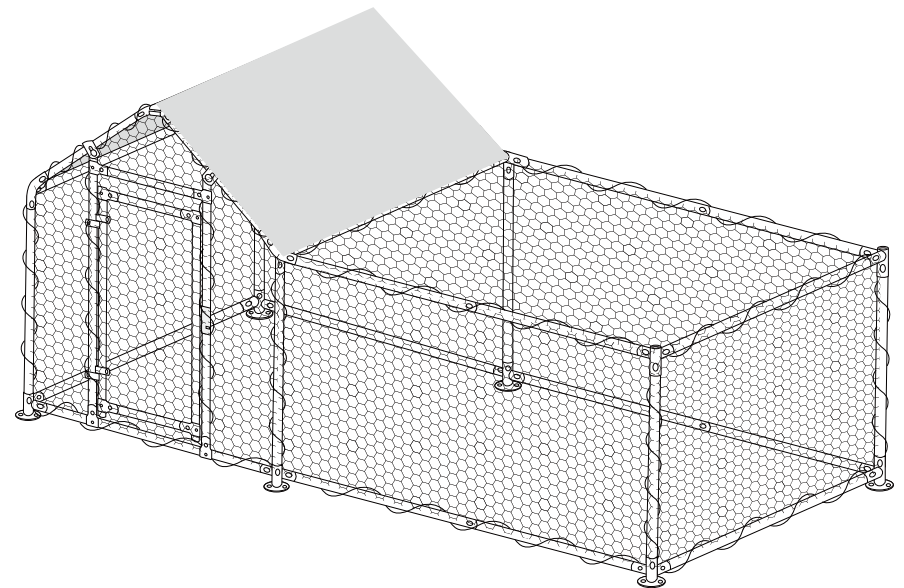

43FLAT ROOF CHICKEN COOP



Owner's Manual













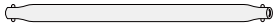















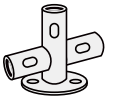
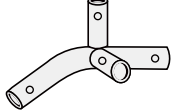
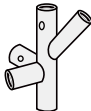

Missing parts, damages, and any problems in the installation process, please contact us by text or email. Please choose SMS or email as your first choice for communicating with us.

 +1(631)306-4783

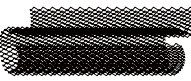
 hellovitesse@gmail.com

  Please read this manual carefully before assembly

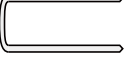
Parts list

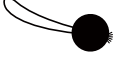
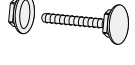
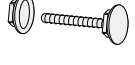
- | | | | | |
|--|--|--|--|--|
|  1 x7pcs 35.3inch pipe |  2 x4pcs 38.8inch pipe |  3 x6pcs 34.4inch pipe | | |
|  4 x4pcs 38.8inch pipe |  5 x1pcs 45.3inch pipe |  6 x1pcs 20.4inch pipe | | |
|  7 x1pcs 34.8inch pipe |  8 x4pcs 18.7inch pipe |  9 x1pcs 36.2inch pipe | | |
|  10 x1pcs 45.3inch pipe |  A x2pcs 39.4inch |  C x2pcs 16.5inch | | |
|  11 x1pcs |  12 x1pcs |  B x2pcs |  D x4pcs | |
|  E x2pcs |  F x2pcs |  G x1pcs |  H x1pcs | |
|  I x2pcs |  J x2pcs |  K x1pcs |  L x1pcs | |
|  M x1pcs |  N 13mx1 |  O x20pcs |  P x2pcs |  Q x1pcs Roof |
|  R xNpcs |  S xNpcs |  T xNpcs |  V x10pcs M8 |  W x4pcs M10 |

Please wear gloves when installing to prevent hurts

Installation steps

Step 1

- 4** x2 **E** x4
2 x2 **F** x2
1 x4

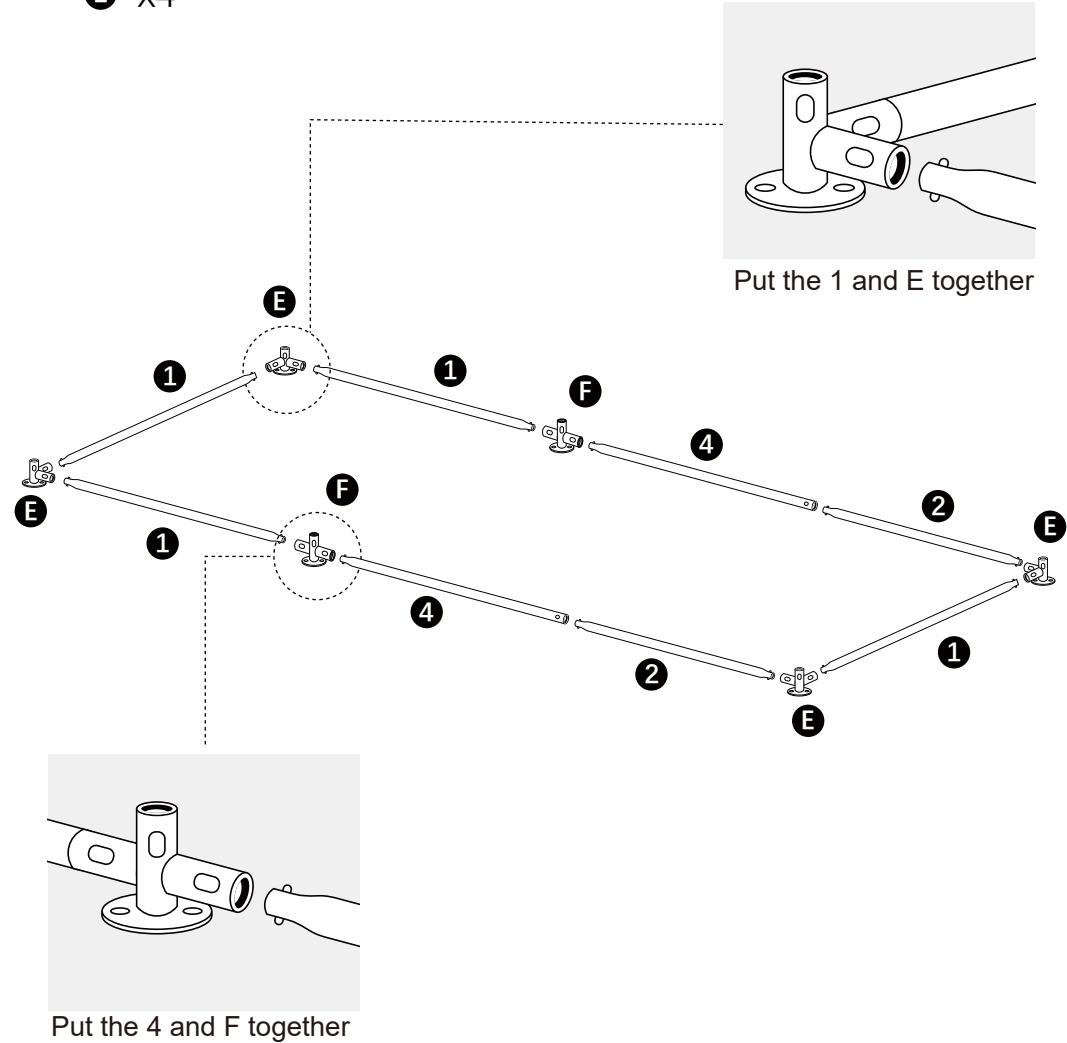

Step 2

③ x6

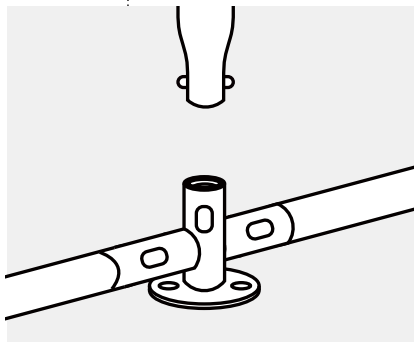
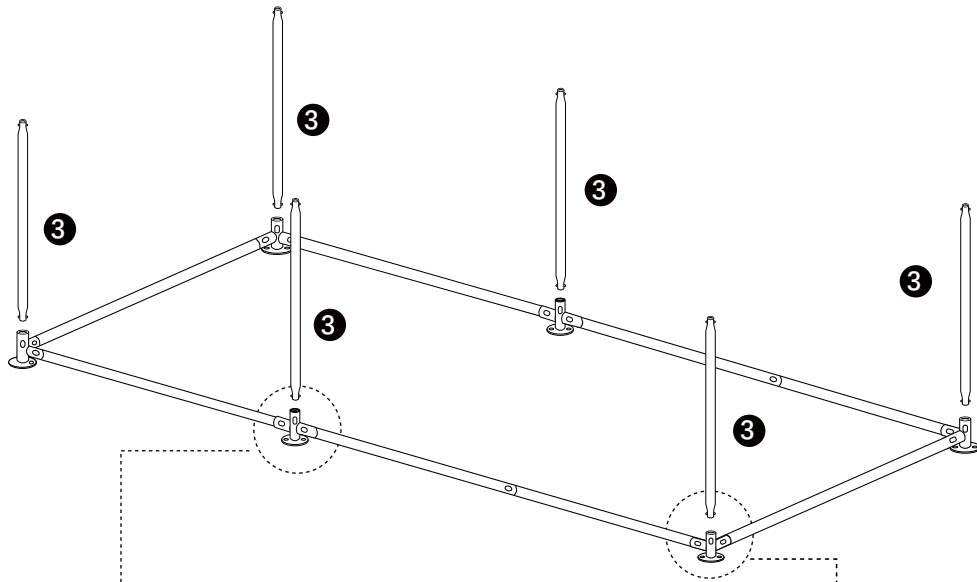

Put the 3 and F together

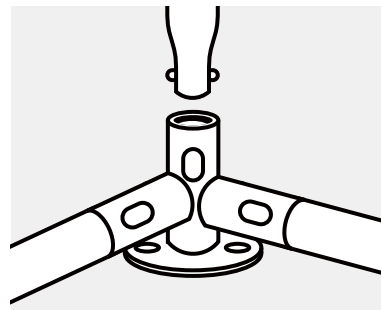

Put the 3 and E together

Step 3

② x4

H x2

D x4

Put the 11 and 1,7 together

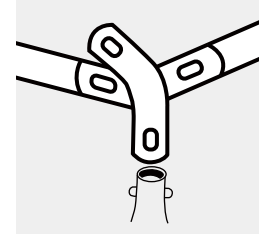

Put the H and 4,7 together

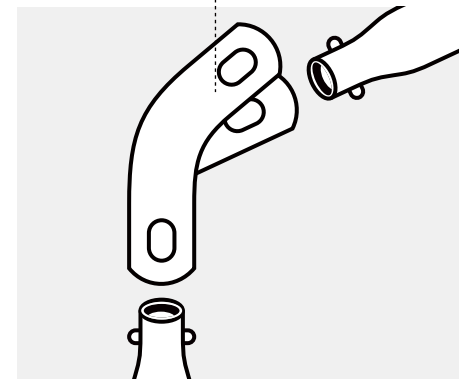
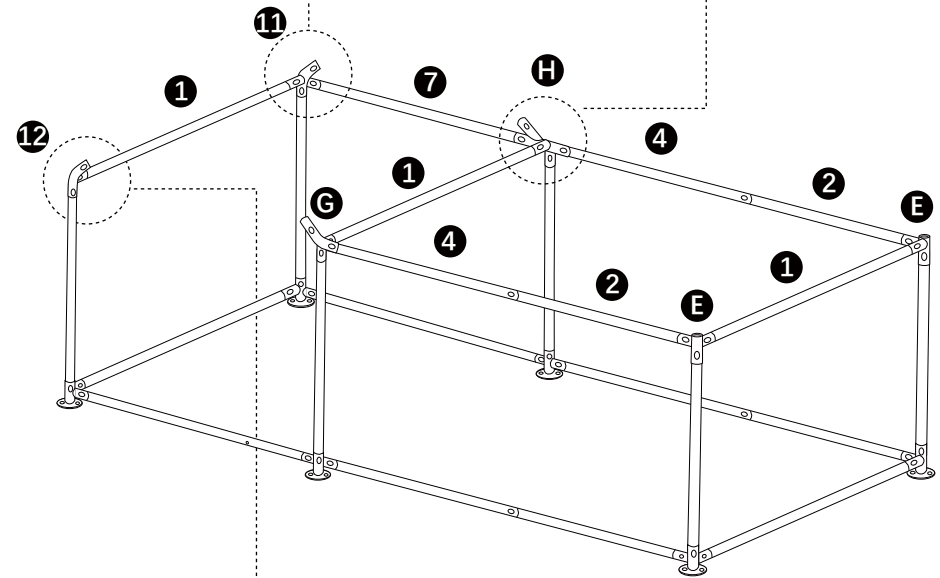
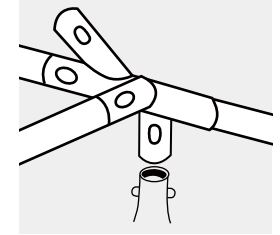

Put the 12 and 1 together

Step 4

- 3** x9
- 2** x4
- D** x4
- H** x2

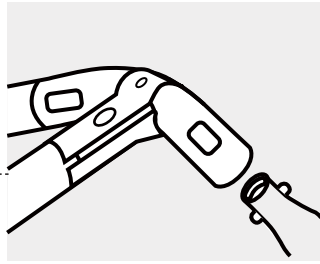

Let's put the O, B and 8 together

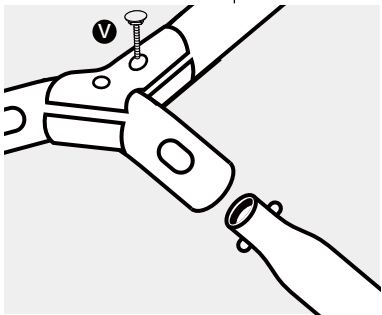
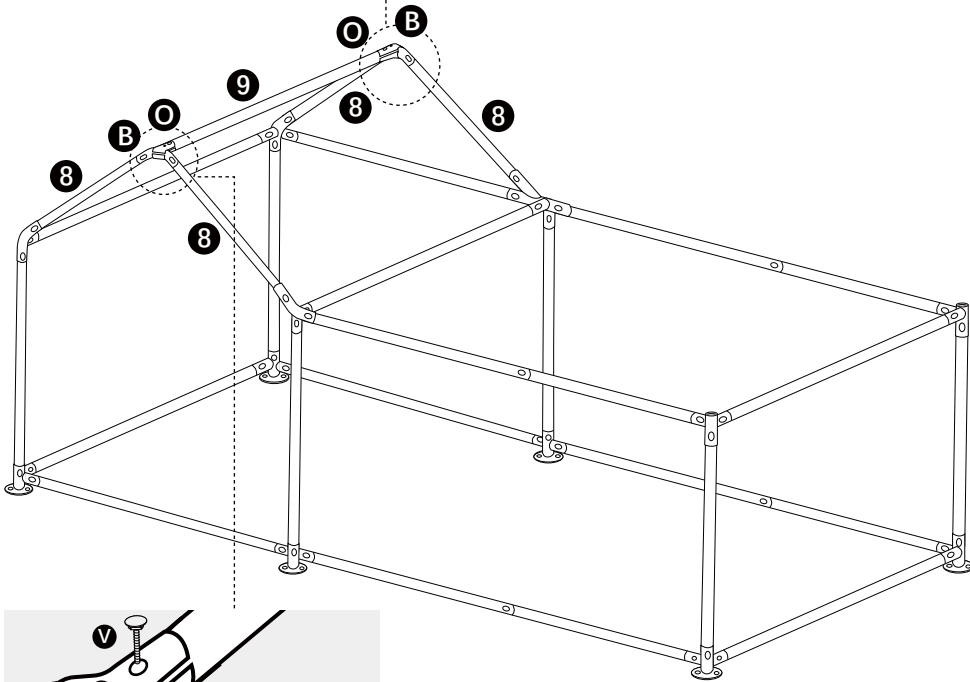

Let's put the O and 9 together

Step 5

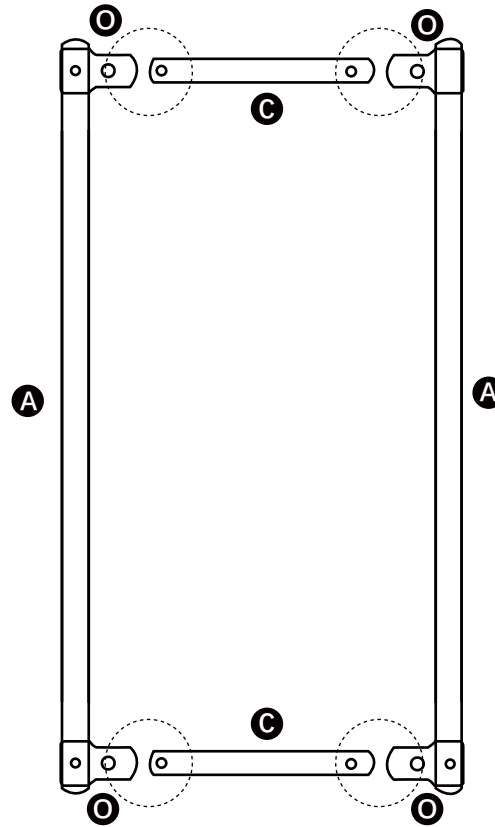

- A** x2
- C** x2
- O** x4

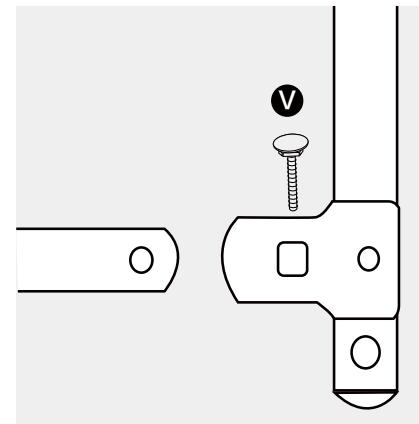

- V** x4

Put the O and C together

Step 6

- 5 x1
- 10 x1
- 0 x4
- 6 x1

- V x2

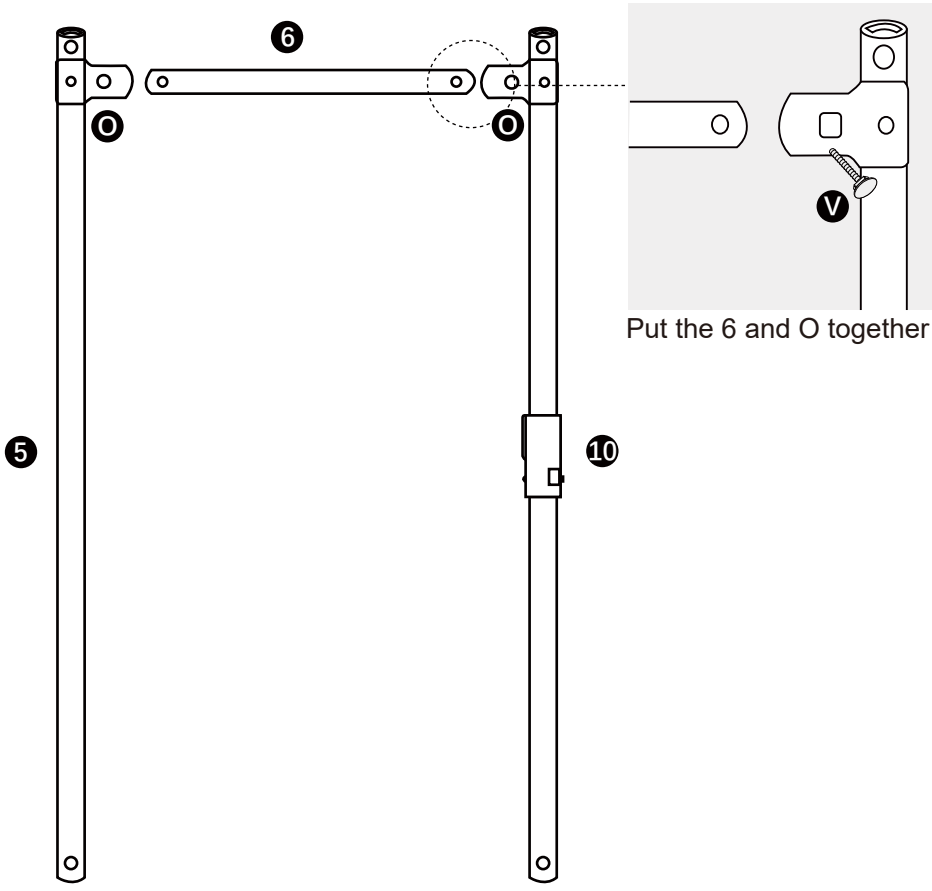

Step 7

- I x2
- J x2

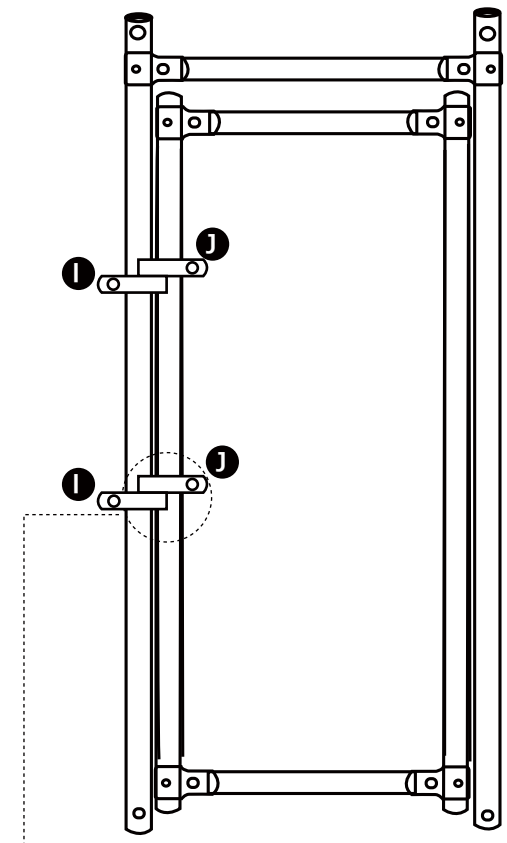

- W x4

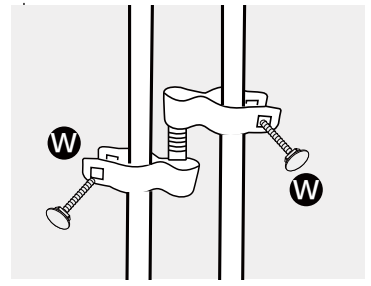

Put the J and I together

Step 8

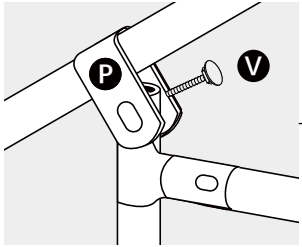

V x4

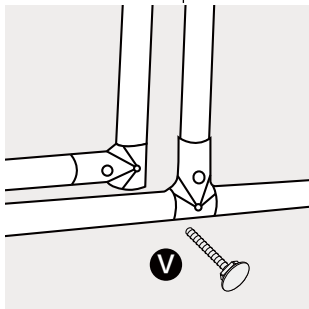
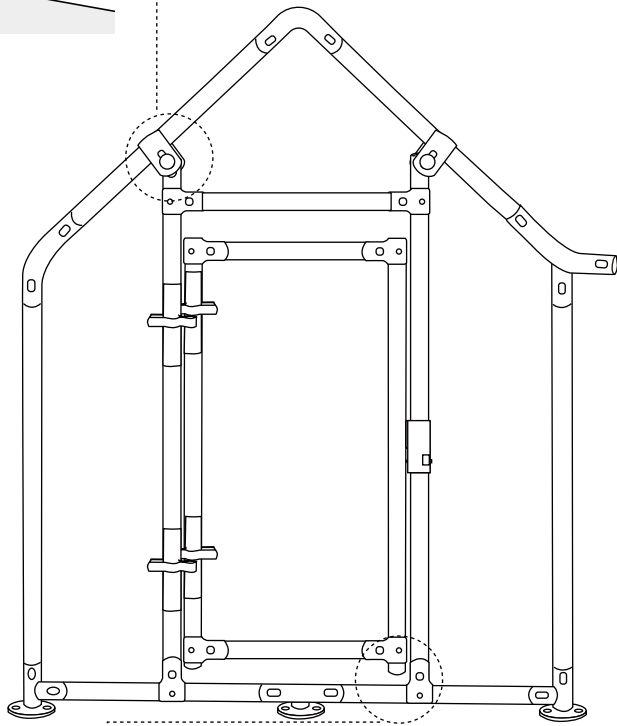

Secure the door with the V screws

Step 9

2. Then forcefully straighten the part N to make the chicken coop stable

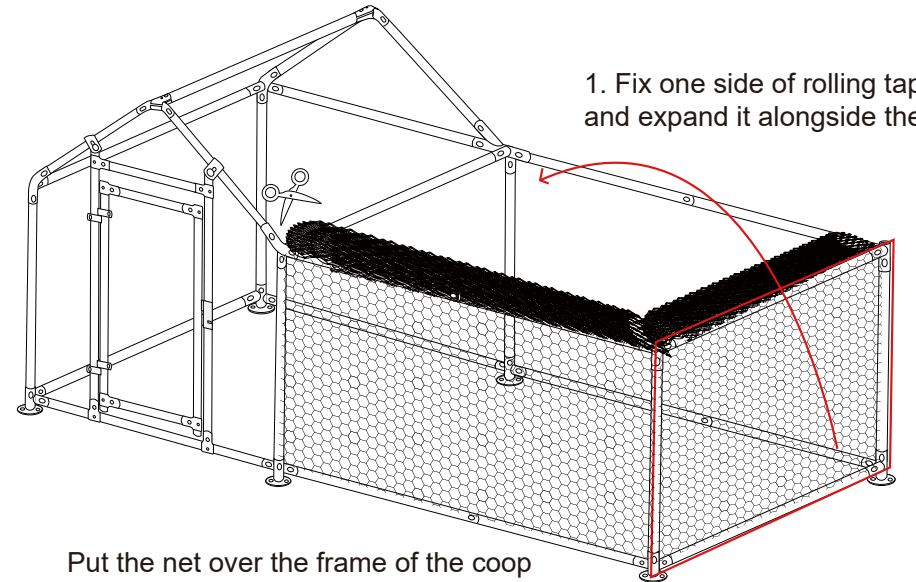

1. Fix one side of rolling tape and expand it alongside the roof

Put the net over the frame of the coop

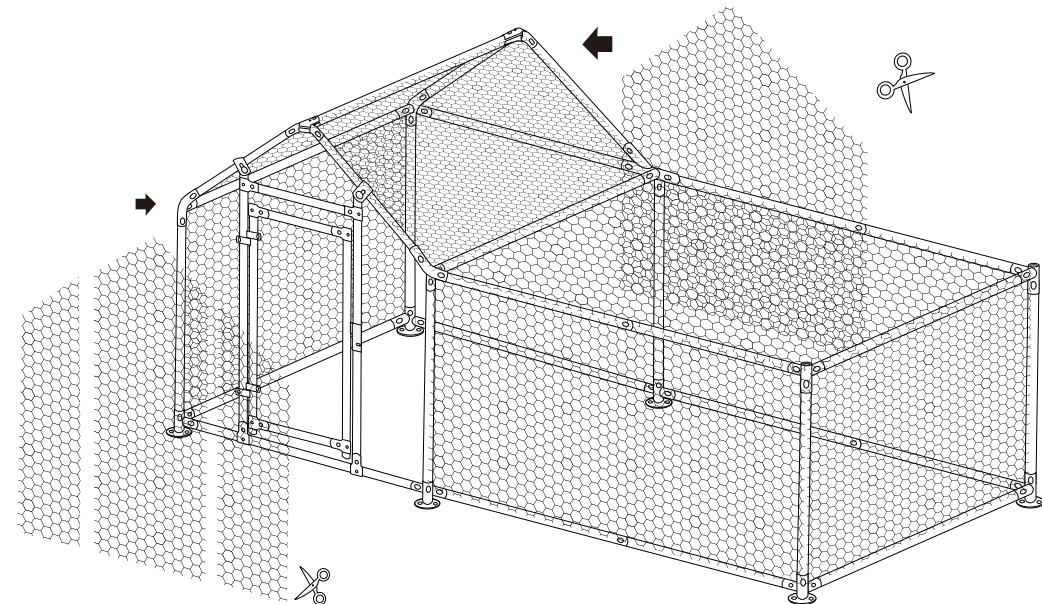

Cut off the extra chicken coop mesh

Then fix the part shown in the picture with rolling tape

Step 10

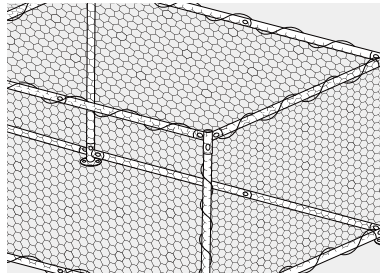
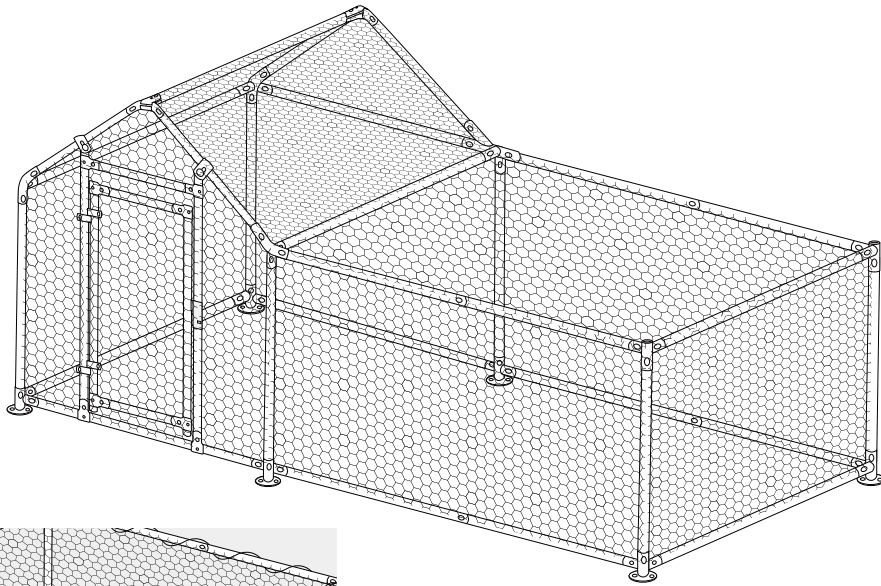

Lock the net cover to the coop via tie straps

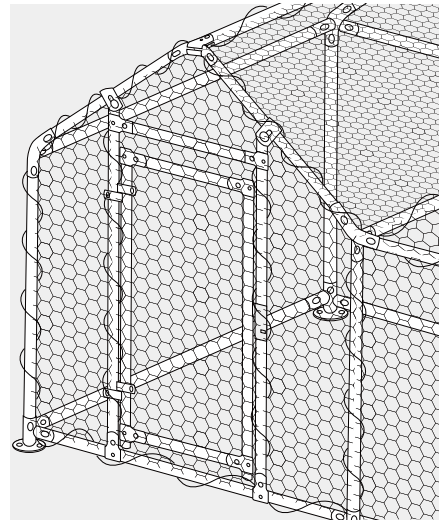
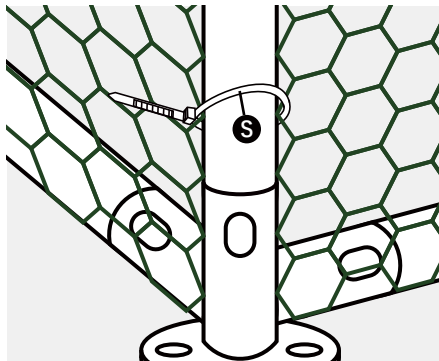

Secure the whole net cover was locked with tie straps

Step 11

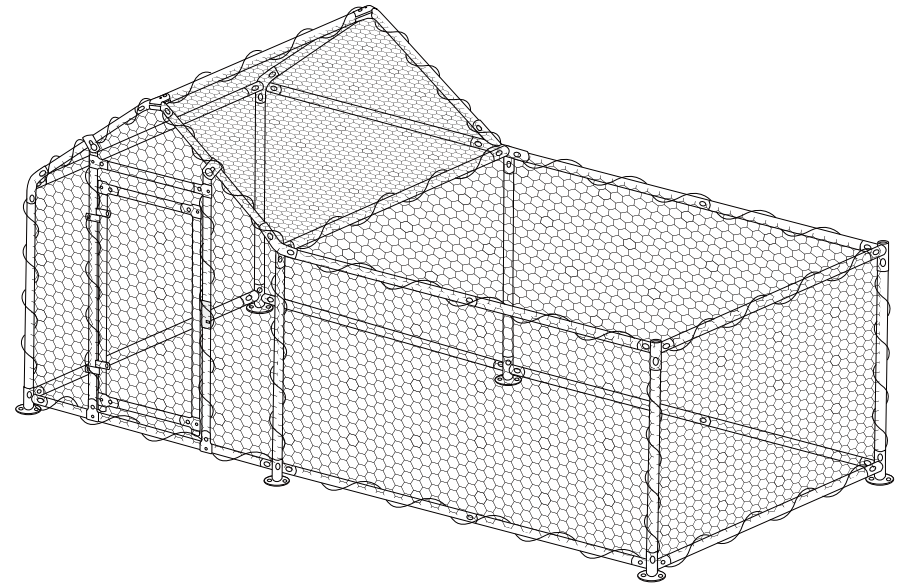

Secure all coop nets with cable ties

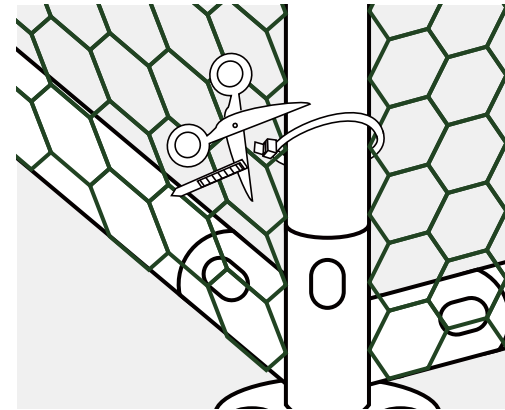

Cut the excess off the cable ties

Step 12

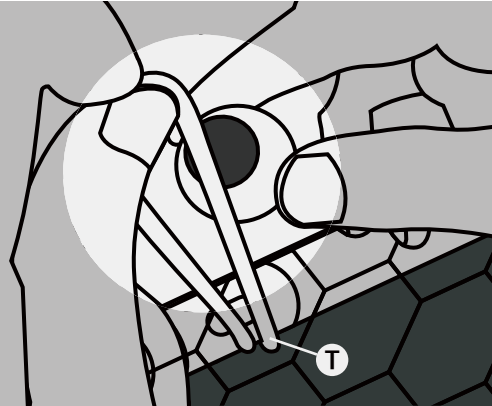
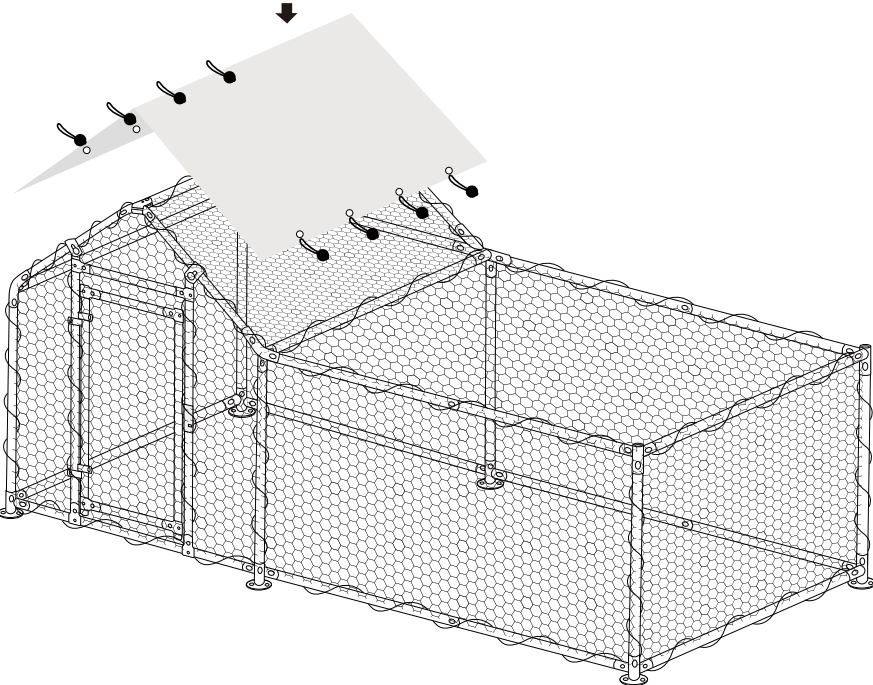

Step 13

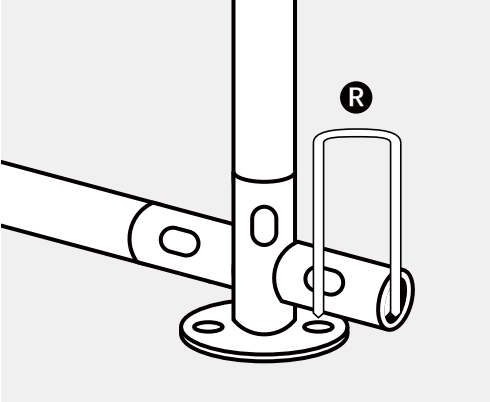
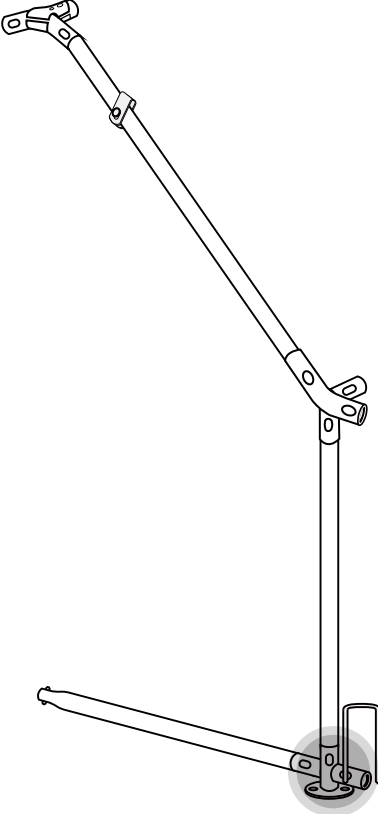

Q&A

1.

Q: I received an incomplete product, and the product package is broken, what should I do?

A: Please contact us and tell customer service the name and quantity of the missing parts you need. We will provide the replacement for you after confirm. If the package was damaged, please send some pictures to us, we will do the same things. Thank you!

2.

Q: I checked the instructions but it is difficult to put the coop up. Can you help me?

A: Please find our YouTube channel (vitesse gaming), we uploaded the installation video of the coop (named: Vitesse Chicken Coop Assemble Video Manual). If you still cannot assemble after viewing the video, please contact us and we will provide solutions for your installation steps.

Contact us



+1(631)306-4783



hellovitesse@gmail.com

Please feel free to **send us the text or email**. We will reply to you within 24 hours. Also please feel free to contact us if you have received the defective items. Due to time zone differences, please use email as your first choice to communicate with us.



Instagram: vitesse gaming



YouTube : vitesse gaming

Follow our YouTube Channel then you will be able to find our **assembling video** as a pinned video.