

ASSEMBLY INSTRUCTION

INSTRUCTIONS DE MONTAGE

Caution: You must read this before you proceed
Attention: Vous devez lire ceci avant de continuer

(N737P416361/N737P416362)

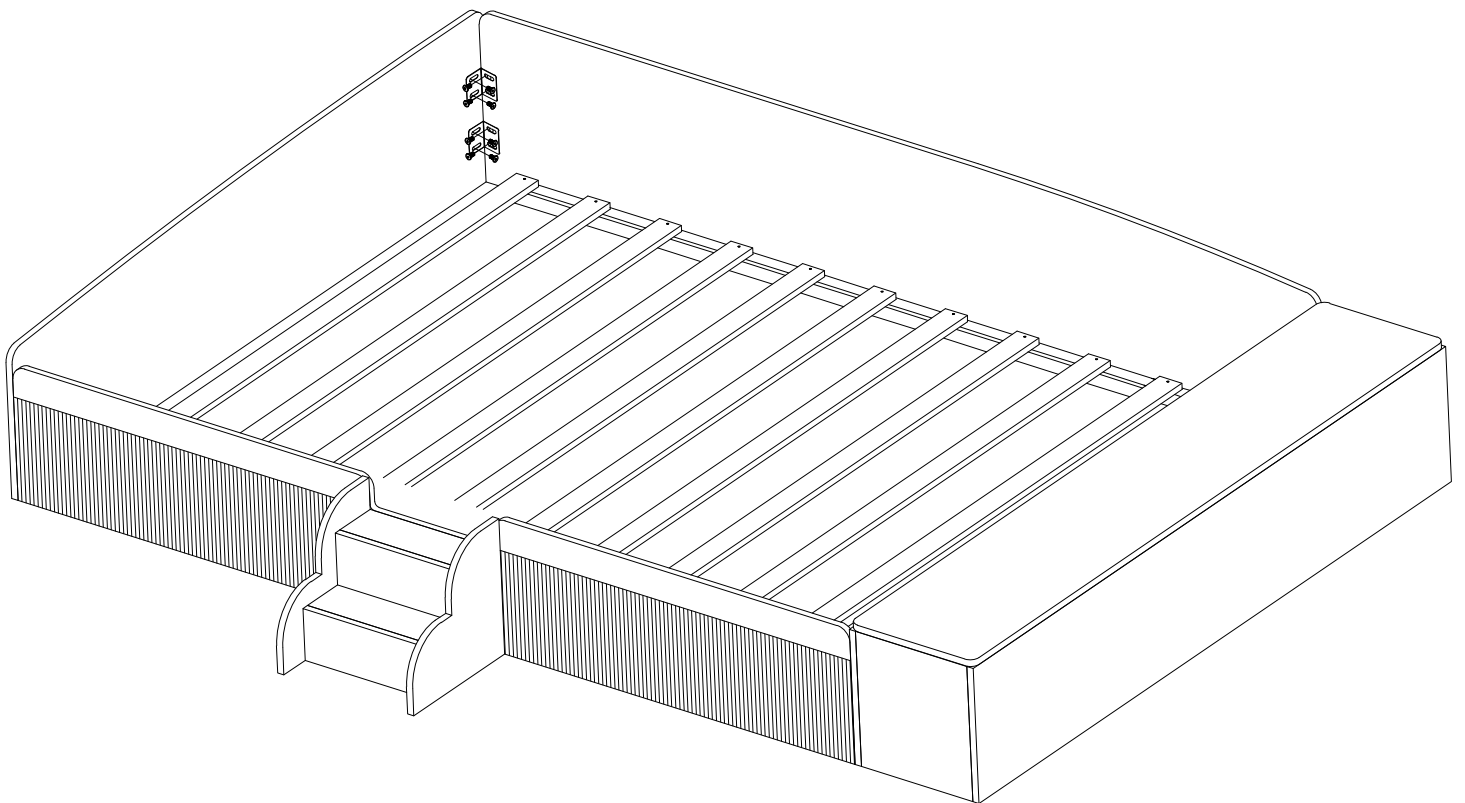

Assembly Step / Étape d'assemblage

Overview

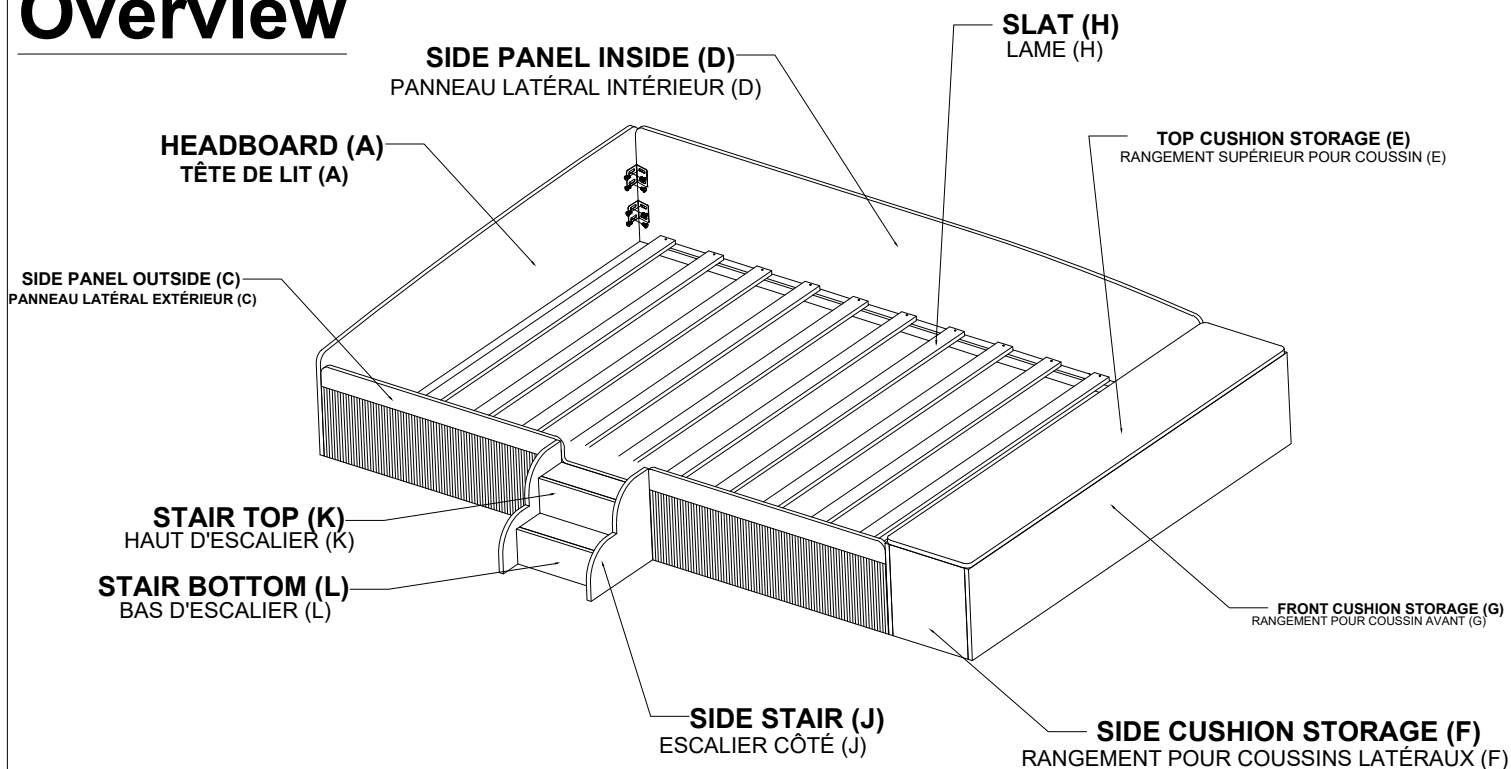

This N737P416361/N737P416362 has multiple parts and may require up to 50 minutes to assemble. To give you an overview of the N737P416362 parts, the above picture is to help you put the various parts into perspective. Please read through the instructions below to familiarize yourself with the part and steps before assembly.

Ce N737P416361/N737P416362 comporte plusieurs pièces et peut nécessiter jusqu'à 50 minutes pour l'assembler. Pour vous donner un aperçu des pièces N737P416362, l'image ci-dessus est destinée à vous aider à mettre les différentes pièces en perspective. Veuillez lire les instructions ci-dessous pour vous familiariser avec la pièce et les étapes avant l'assemblage.

Part List / Liste des pièces(N737P416361)

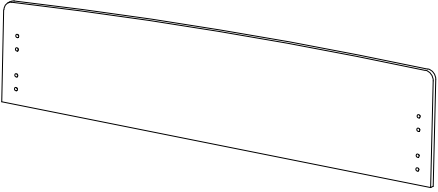
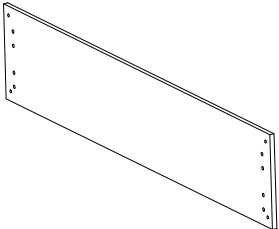
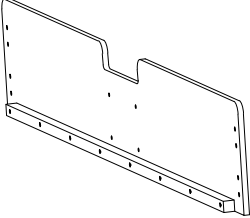
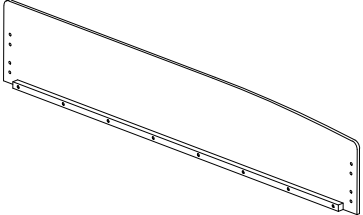
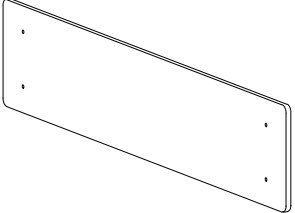
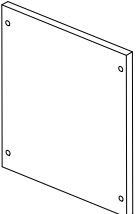
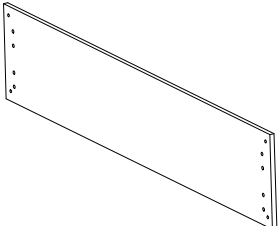
Label/ Étiquette	Picture/ Image	Description	QTY/ Quantité
A		HEADBOARD / TÊTE DE LIT	1
B		FOOTBOARD / PIED DE LIT	1
C		SIDE PANEL OUTSIDE / PANNEAU LATÉRAL EXTÉRIEUR	1
D		SIDE PANEL INSIDE / PANNEAU LATÉRAL INTÉRIEUR	1
E		TOP CUSHION STORAGE / RANGEMENT SUPÉRIEUR POUR COUSSIN	1
F		SIDE CUSHION STORAGE / RANGEMENT POUR COUSSINS LATÉRAUX	2
G		FRONT CUSHION STORAGE / RANGEMENT POUR COUSSIN AVANT	1

Part List / Liste des pièce(N737P416362)

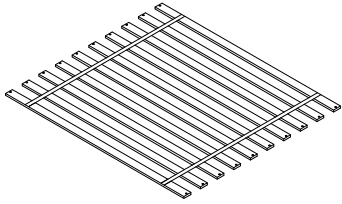
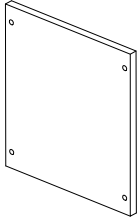
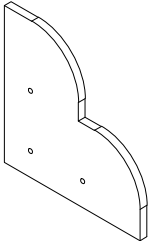
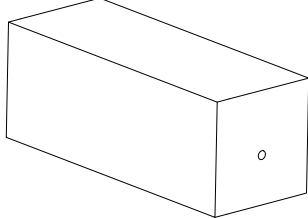
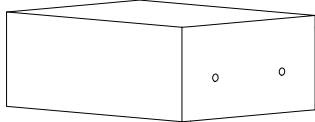
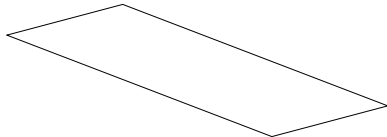
Label/ Étiquette	Picture/ Image	Description	QTY/ Quantité
H		SLAT / LAME	1SET/ 10pcs
I		PARTITION	1
J		SIDE STAIR / ESCALIER CÔTÉ	2
K		STAIR TOP / HAUT D'ESCALIER	1
L		STAIR BOTTOM / BAS D'ESCALIER	1
M		FABRIC / TISSU	1

Part List / Liste des pièces (N737P416361)

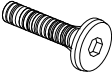
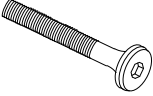
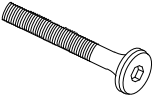
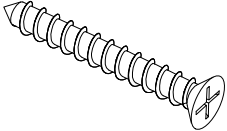
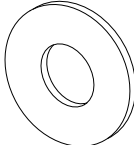
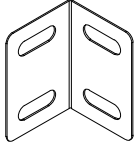
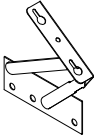
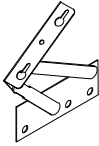
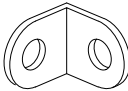
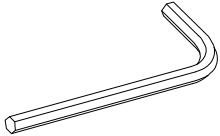
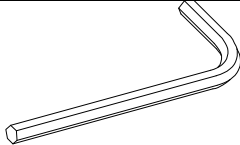
Label/ Étiquette	Picture/ Image	Description	QTY/ Quantité
①		JCBB M8 x 16mm	32
②		JCBC M6 x 16mm	32
③		JCBC M6 x 30mm	10
④		CSK SCREW M4 x 30mm / VIS CSK M4x30mm	6
⑤		Flat Washer M6 / Rondelle Plate M6	10
⑥		BED BRACKET / SUPPORT DE LIT	8
⑦		ANGLE BRACKET-R / Équerre de fixation -R	1
⑧		ANGLE BRACKET-L / Équerre de fixation -L	1
⑨		L-BRACKET (2 HOLE) / SUPPORT EN L (2 TROUS)	12
⑩		Allen Key M4 / Clé Allen M4	1
⑪		Allen Key M5 / Clé allen M5	1

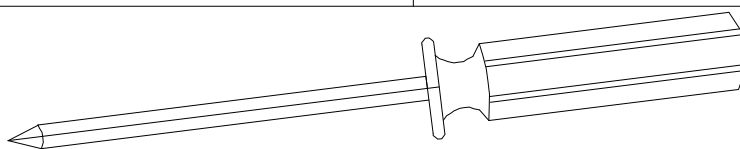

Assembly Tools
Required (Not Included)

Assembly Preparation / Préparation de l'assemblage

Before
Beginning
Assembly
/
Avant de
commencer
l'assemblage

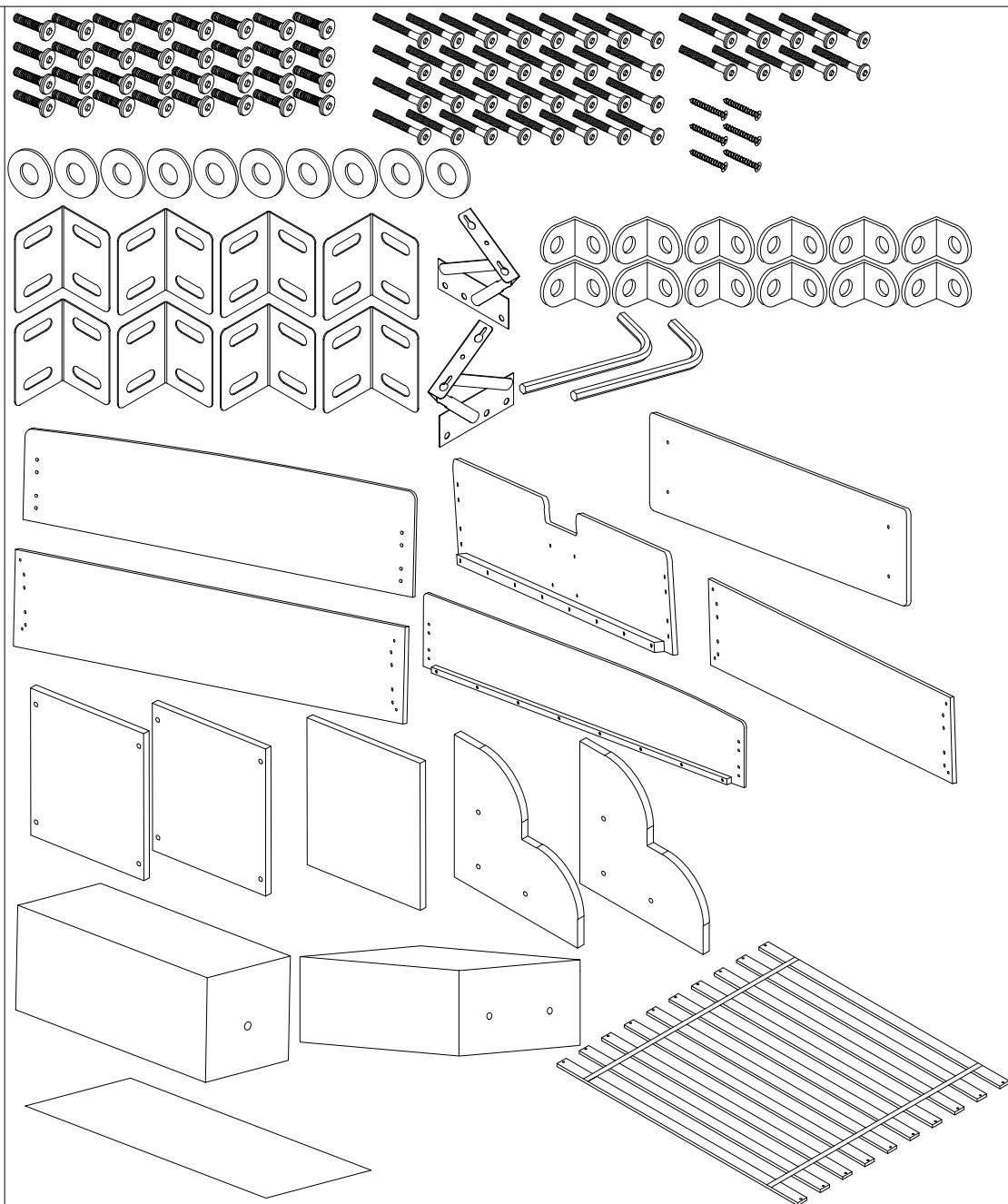

- Read instructions, cover to cover-



- Have 2 adults on hand for assembly-



- Do not assemble on flooring or carpet-



- Assemble on a clean non-marring surface (packing foam)-



- Save all packaging until finished-



- Lire les instructions, de bout en bout



- Avoir 2 adultes à portée de main pour l'assemblage



- Ne pas assembler sur un sol ou un tapis



- Assembler sur une surface propre ne marquant pas (mousse d'emballage)



- Conservez tous les emballages jusqu'à la fin

Assembly Step / Étape d'assemblage

Step 1

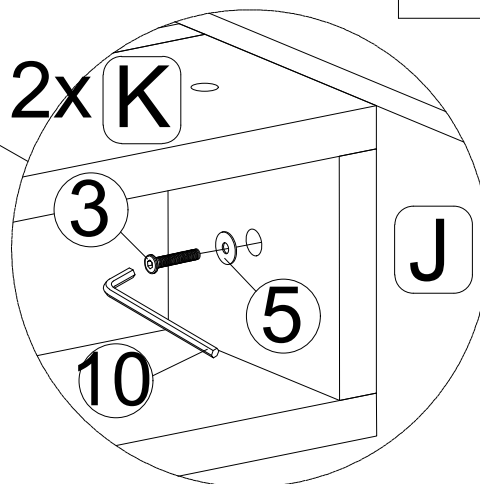
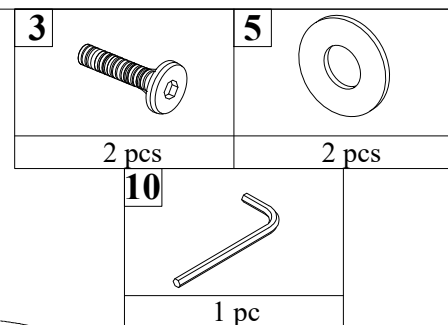
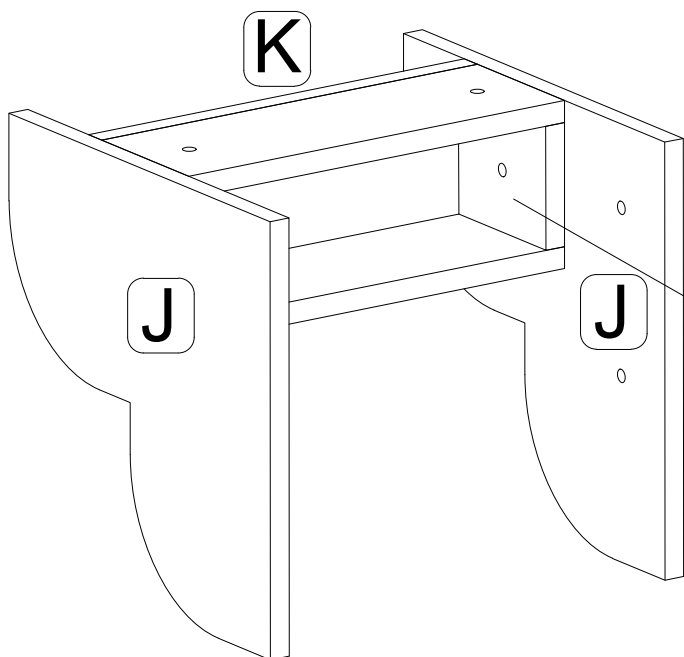

Connect the Side stair (J) to the Stair top (K) by placing JCBC M6 x 30mm (3) 2 pieces and flat washer (5) 2 pieces tie up by using the Allen Key (10).
***Tighten by turning the JCBC M6 x 30mm (3) by Allen Key M4 (10) clockwise.**

Connectez Escalier latéral (J) au Dessus d'escalier (K) en plaçant 2 pièces JCBC M6 x 30 mm (3) et 2 pièces rondelle plate (5) du tournevis Allen. Clé (10).
***Serrez en tournant le JCBC M6 x 30 mm (3) à l'aide de la clé Allen M4 (10) dans le sens des aiguilles d'une montre.**

Step 2

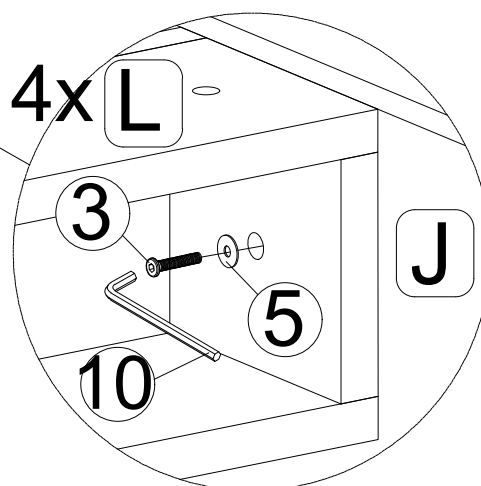
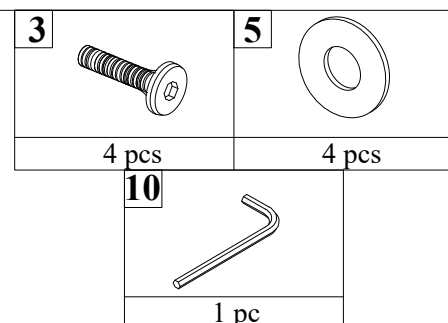
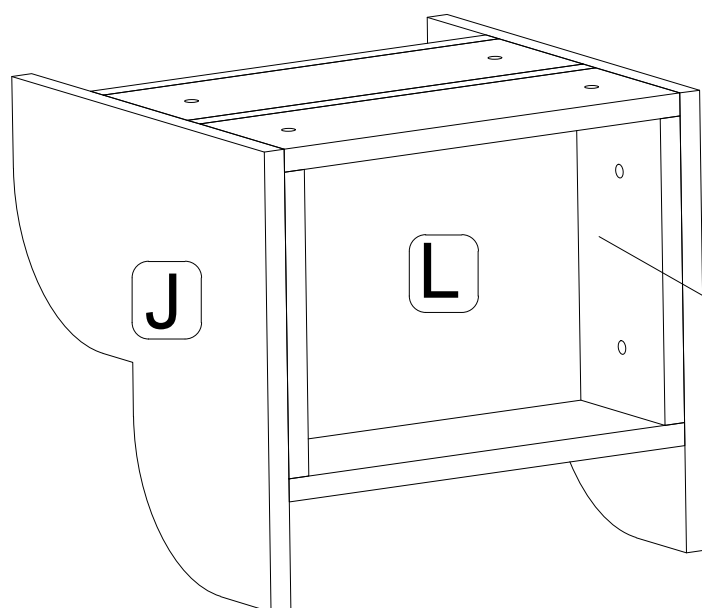

Connect the Side stair (J) to the Stair top (L) by placing JCBC M6 x 30mm (3) 4 pieces and flat washer (5) 4 pieces tie up by using the Allen Key (10).
***Tighten by turning the JCBC M6 x 30mm (3) by Allen Key M4 (10) clockwise.**

Connectez Escalier latéral (J) au Dessus d'escalier (L) en plaçant 4 pièces JCBC M6 x 30 mm (3) et 4 pièces rondelle plate (5) du tournevis Allen. Clé (10).
***Serrez en tournant le JCBC M6 x 30 mm (3) à l'aide de la clé Allen M4 (10) dans le sens des aiguilles d'une montre.**

Assembly Step / Étape d'assemblage

Step 3

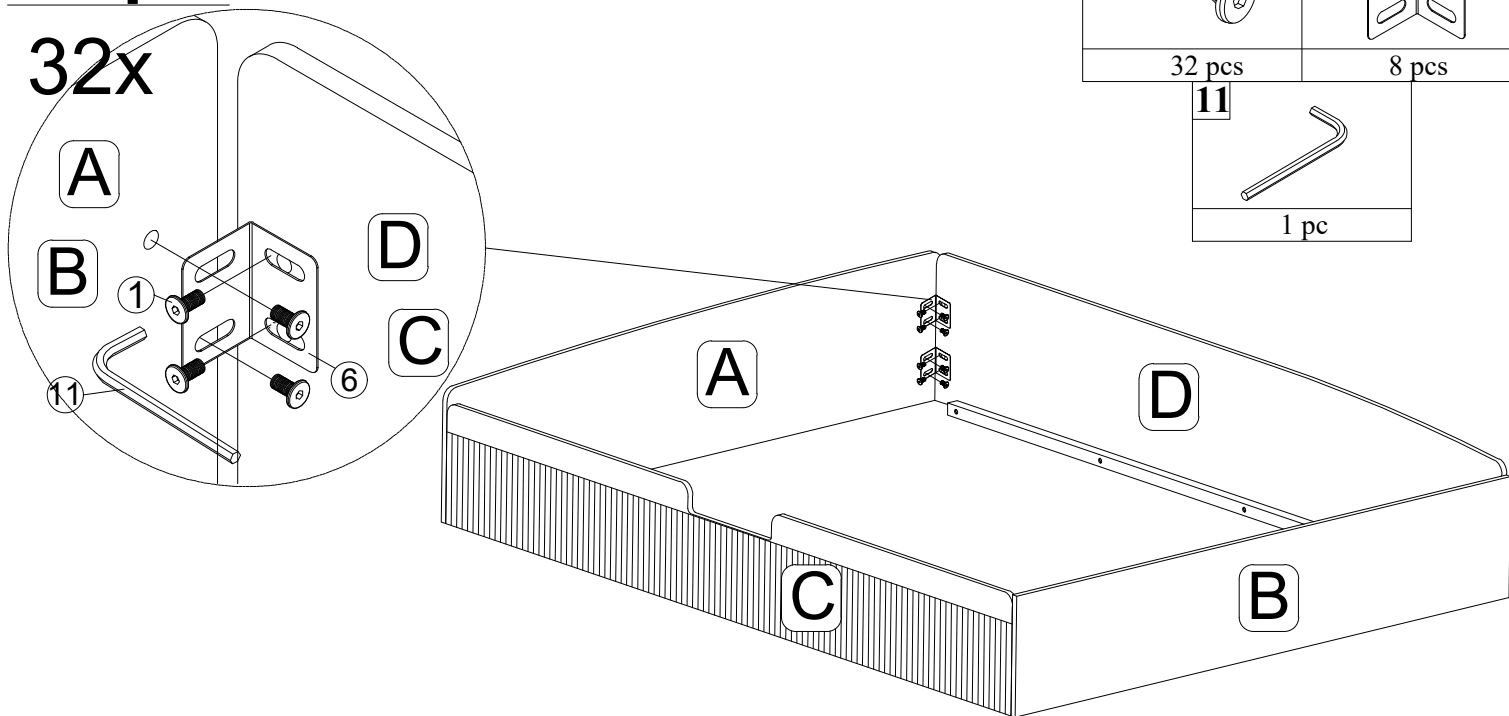

Connect the Headboard (A) to the Side Panel Inside(D) and Side Panel Outside(C) by placing JCBB M8 x 16mm (1) 8 pieces and bed bracket (6) 2 pieces on every corner and tie up by using the Allen Key (11).
***Tighten by turning the JCBB M8 x 16mm (1) by Allen Key M5 (11) clockwise.**

Connectez la tête de lit (A) au panneau latéral intérieur (D) et au panneau latéral extérieur (C) en plaçant 8 pièces JCBB M8 x 16 mm (1) et le support de lit (6) 2 pièces à chaque coin et attachez-les à l'aide du tournevis Allen. Clé (11).
***Serrez en tournant le JCBB M8 x 16 mm (1) à l'aide de la clé Allen M5 (11) dans le sens des aiguilles d'une montre.**

Step 4

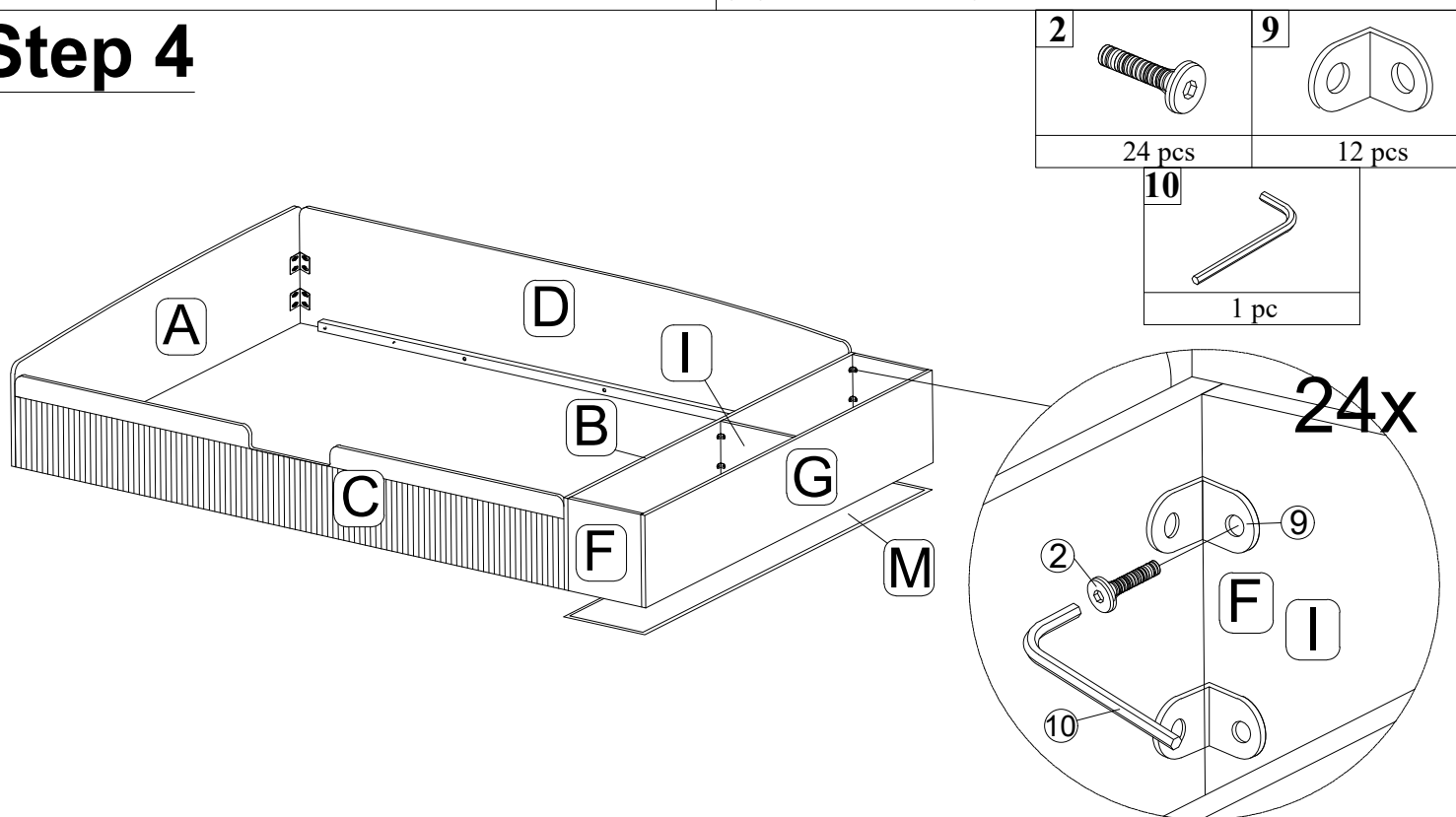

Attach the Side cushion storage (F) and Partition (I) to the Footboard (B) and Front cushion storage (G) by placing JCBC M6 x 16 mm (2) 24 pieces and L-bracket (2 hole) (9) 12 pieces tie up by using the Allen Key (10).
***Tighten by turning the JCBC M6 x 16mm (2) by Allen Key M4 (10) clockwise.**

Fixez le compartiment de rangement latéral (F) et la cloison (I) au pied de lit (B) et au compartiment de rangement avant (G) à l'aide des vis JCBC M6 x 16 mm (2) 24 pièces et des équerres (2 trous) (9) (12 pièces), en les serrant avec la clé Allen (10).
***Serrez les vis JCBC M6 x 16 mm (2) en tournant la clé Allen M4 (10) dans le sens horaire.**

Assembly Step / Étape d'assemblage

Step 5

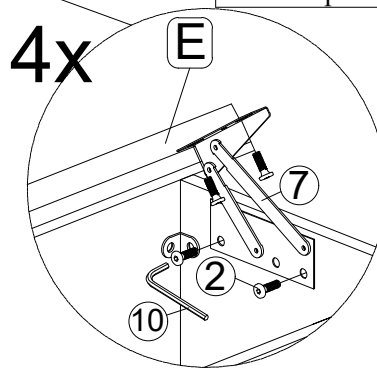
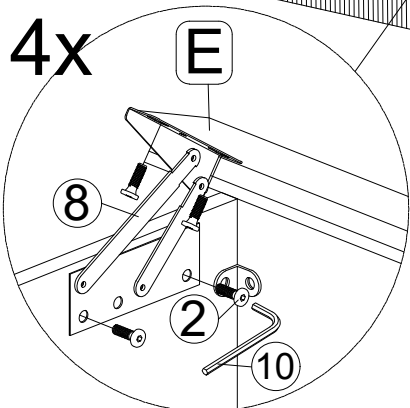
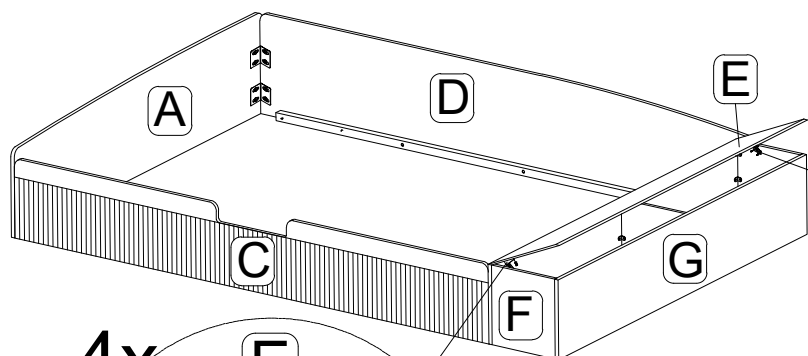

2		7	
	8 pcs		1 pc
8		10	
	1 pc		1 pc

Attach the Top cushion storage (E) to the Side cushion storage (F) and by placing JCBC M6 x 16 mm (2) 8 pieces and Angle bracket (L) (8) 1 and Angle bracket (R) (7) 1 pieces tie up by using the Allen Key (10).
***Tighten by turning the JCBC M6 x 16mm (2) by Allen Key M4 (10) clockwise.**

Fixez le compartiment de rangement du coussin supérieur (E) au compartiment de rangement latéral (F) à l'aide des vis JCBC M6 x 16 mm (2) (8 pièces), des équerres (L) (8) (1 pièce) et des équerres (R) (1 pièce) (1 pièce).
***Serrez ensuite les vis JCBC M6 x 16 mm (2) à l'aide de la clé Allen M4 (10) dans le sens horaire.**

Step 6

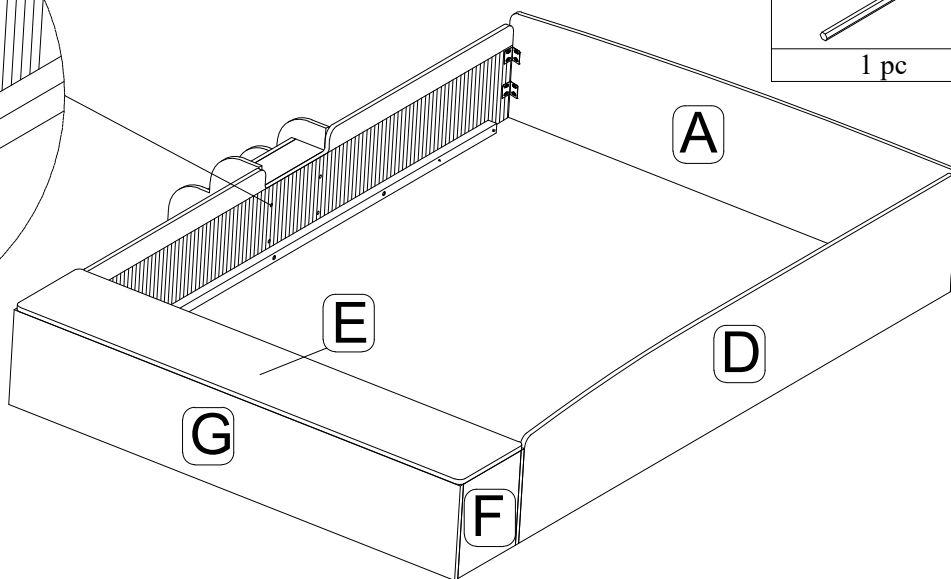
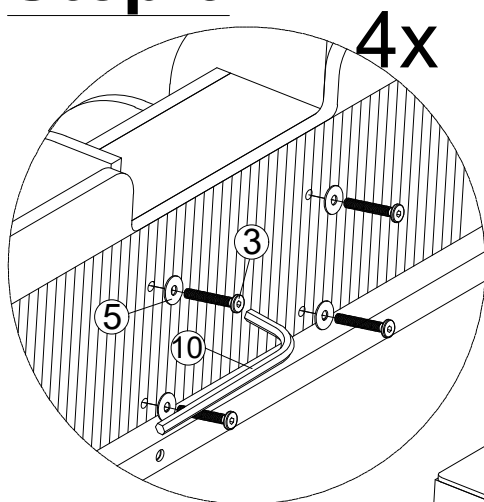

3		5	
	4 pcs		4 pcs
		10	
			1 pc

Attach the Stair to the Side Panel Outside (C). The Stair position can be set using JCBC M6x30mm(3)4 pieces and flat washer M6(5)4 pieces tie up by using Allen key (10).
***Tighten by turning JCBC M6 x 30mm(3) using Allen key (10)**

Fixez l'escalier au panneau latéral extérieur (C). La position de l'escalier peut être réglée à l'aide de 4 vis JCBC M6 x 30 mm (3) et de 4 rondelles plates M6 (5), serrées avec une clé Allen (10).
***Serrez les vis JCBC M6 x 30 mm (3) à l'aide de la clé Allen (10).**

Assembly Step / Étape d'assemblage

Step 7

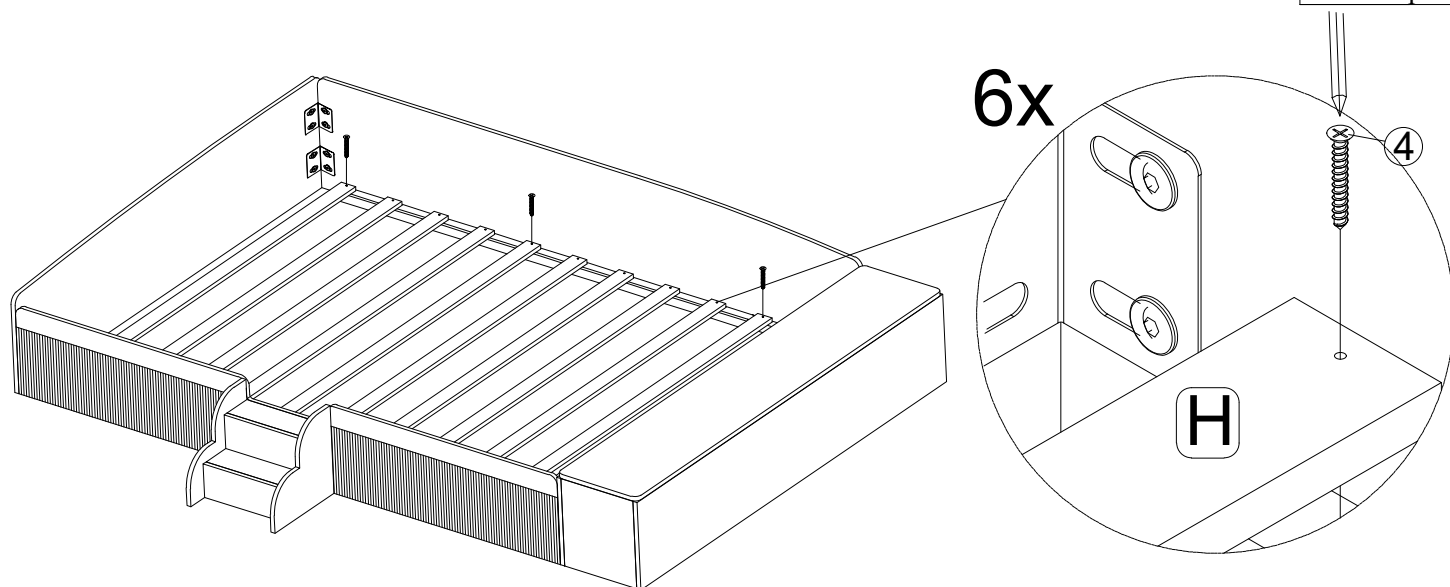

Install the Slat (H) on the base of the side wood already attached to the Inside Panel (D) and Outside Panel (C).

*Slat position (H) can be fixed by using CSK M4 x 30mm Screws (4) 20 (TWENTY) pieces, each slat(H) uses 2 (TWO)2 pieces.

Installez la latte (H) sur la base du bois latéral déjà fixé au panneau intérieur (D) et au panneau extérieur (C).

*La position des lattes (H) peut être fixée à l'aide de vis CSK M4 x 30 mm (4) 20 (VINGT) pièces, chaque latte(H) utilise 2 (DEUX)2 pièces.

Step 8

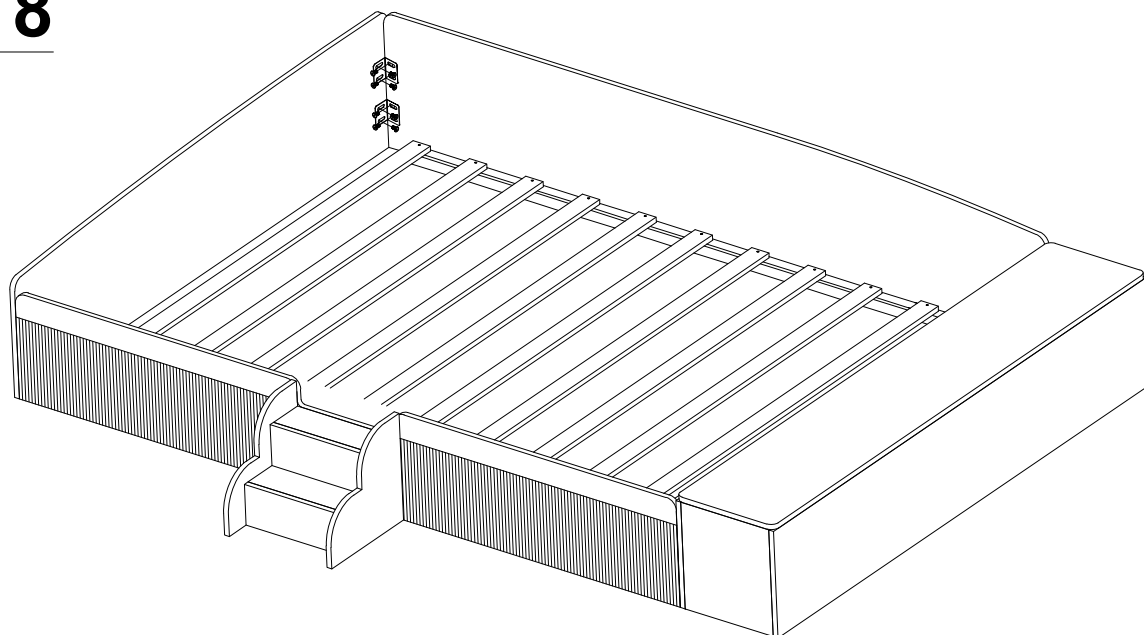

FULLY COMPLETED ASSEMBLY / ASSEMBLAGE ENTIÈREMENT COMPLÉTÉ

Place the Bed right side up and it is ready for use.
This N737P416361/N737P416362 can only be used on a flat, level surface.

Placez le lit à l'endroit et il est prêt à l'emploi.
Ce N737P416361/N737P416362 ne peut être utilisé sur une surface plane et nivelée.