

Bathroom Storage Cabinet
Armoire de Salle de Bain

THIS INSTRUCTION BOOKLET CONTAINS **IMPORTANT** SAFETY INFORMATION.
PLEASE READ AND KEEP FOR FUTURE REFERENCE.

EN



Before You Start

- ⚠ Please read all instructions carefully.
- ⚠ Retain instructions for future reference.
- ⚠ Separate and count all parts and hardware.
- ⚠ Read through each step carefully and follow the proper order.
- ⚠ We recommend that, where possible, all items are assembled near to the area in which they will be placed in use, to avoid moving the product unnecessarily once assembled.
- ⚠ Always place the product on a flat, steady and stable surface.
- ⚠ Keep all small parts and packaging materials for this product away from babies and children as they potentially pose a serious choking hazard.

FR



Avant de Commencer

- ⚠ Veuillez lire attentivement toutes les instructions.
- ⚠ Conservez les instructions pour vous y référer ultérieurement.
- ⚠ Vérifiez toutes les pièces et les accessoires.
- ⚠ Lisez attentivement chaque étape et suivez l'ordre correct.
- ⚠ Nous recommandons que, dans la mesure du possible, tous les produits soient assemblés à proximité de la zone où ils seront utilisés, afin d'éviter tout déplacement inutile du produit une fois assemblé.
- ⚠ Placez toujours le produit sur une surface plane et stable.
- ⚠ Conservez toutes les petites pièces de ce produit et les matériaux d'emballage hors de portée des bébés et des enfants, car ils pourraient présenter un risque d'étouffement.

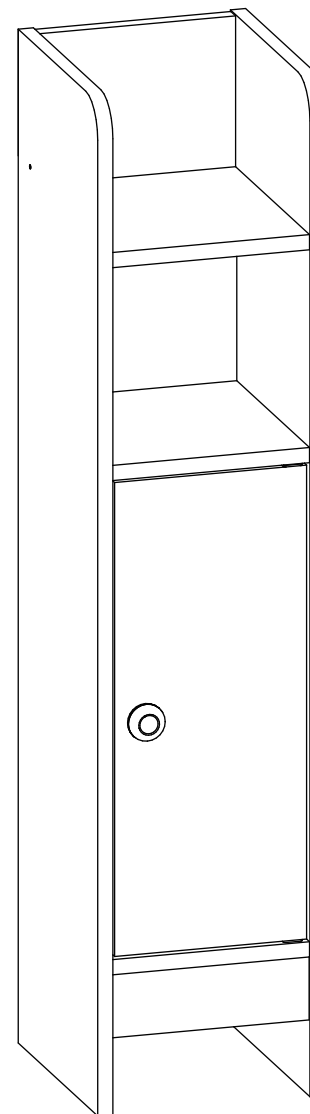

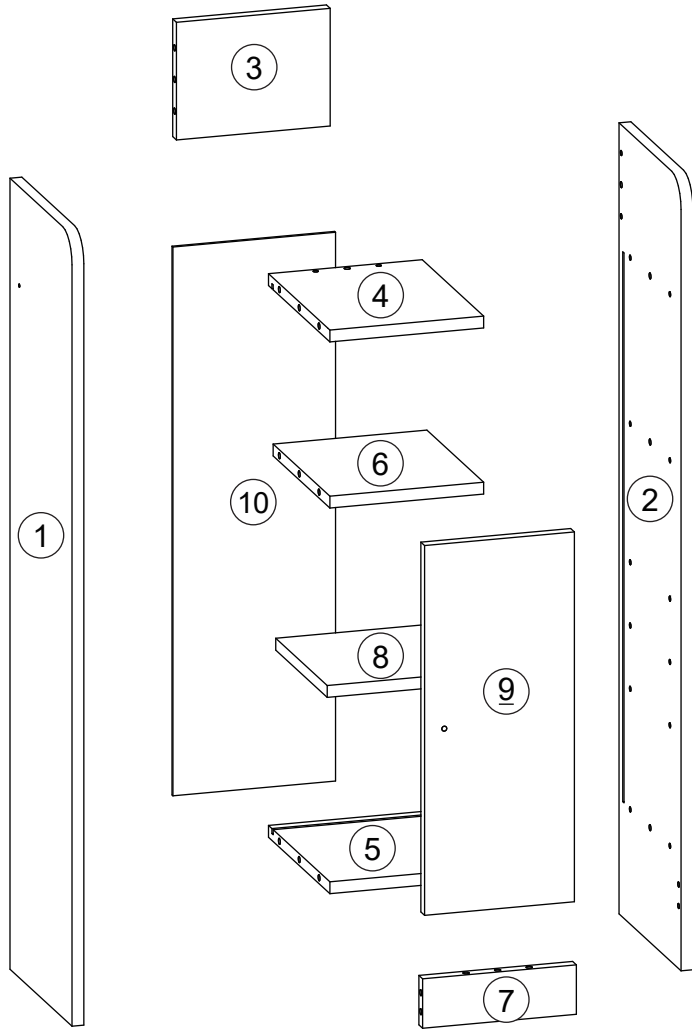

① x1

② x1

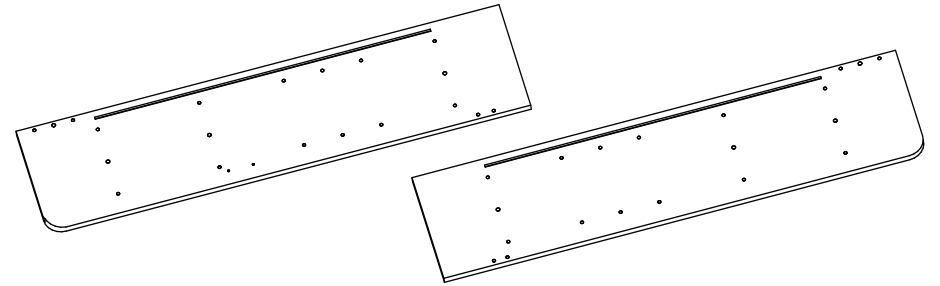

③ x1

④ x1

⑤ x1

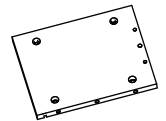
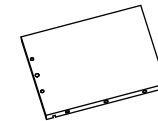
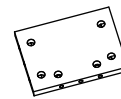

⑥ x1

⑦ x1

⑧ x1

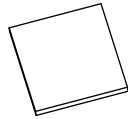
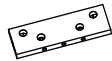
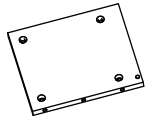

⑨ x1

⑩ x1

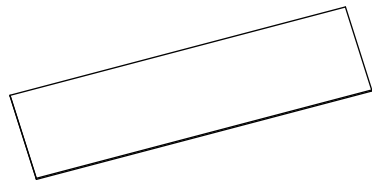
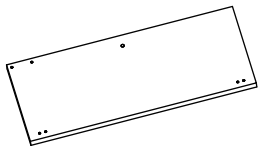

F

H

N

O

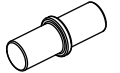
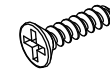
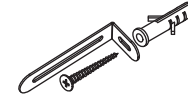

3.5*12mm

x1

x2

x16

x4

X

Y

Z

An

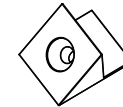
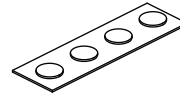

300mm

x1

x6

x22

x22

Ao

Bk

Bn

Es

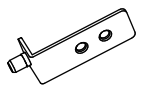
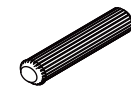
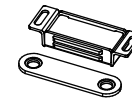

Φ6*30mm

x22

x1

x12

x2

1

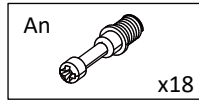

① x1

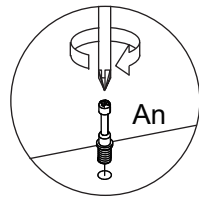
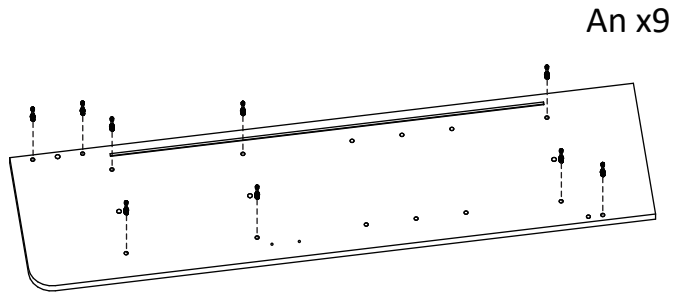

② x1

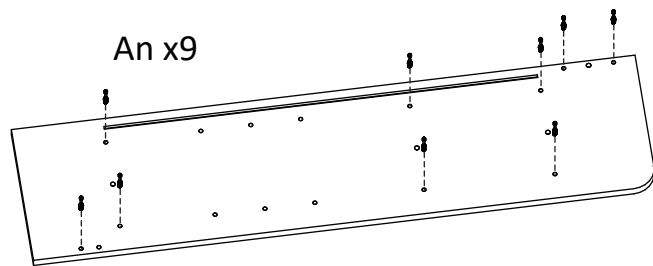

2

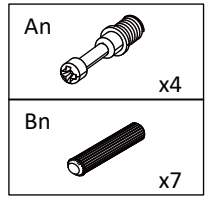

③ x1

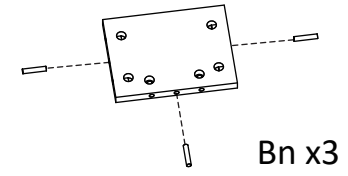

④ x1

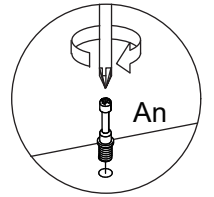
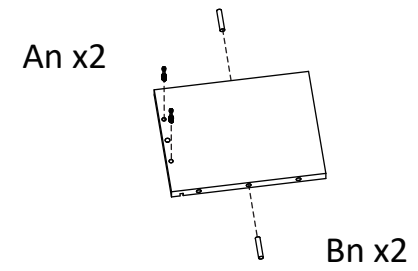

⑤ x1

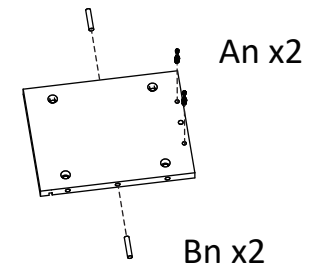

3

⑥ x1

Bn x2

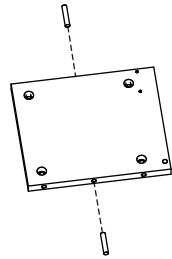

⑦ x1

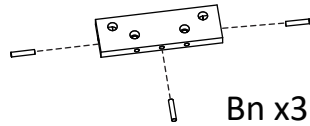

Bn x3

⑨ x1

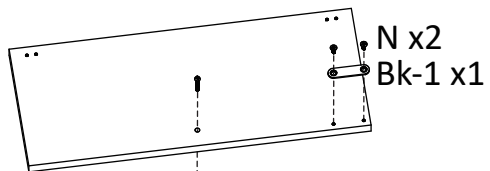

N x2

Bk-1 x1

F x1

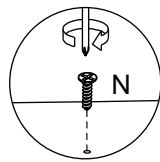

F		x1
N		x2
Bk-1		x1
Bn		x5

4

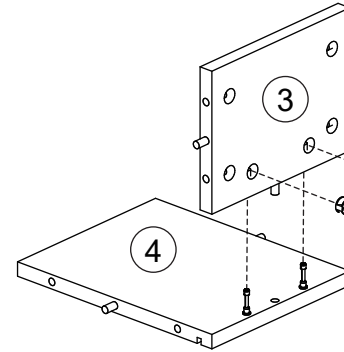

Ao x2

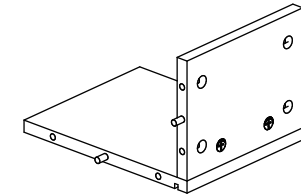

Ao		x2
----	--	----

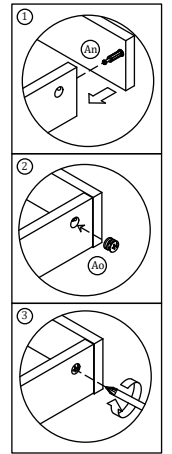

5

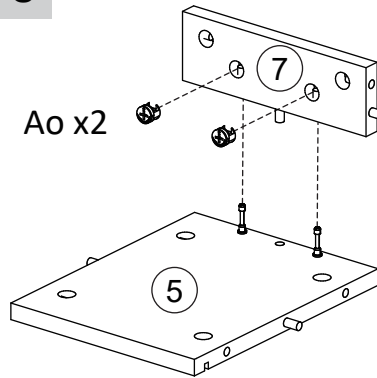

Ao x2

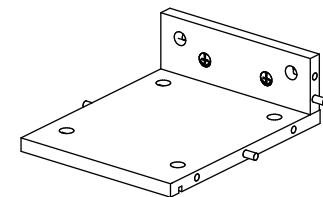

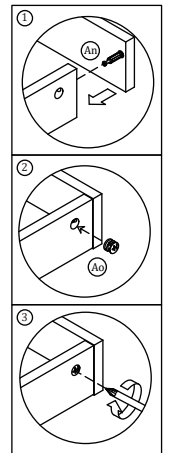

Ao		x2
----	--	----

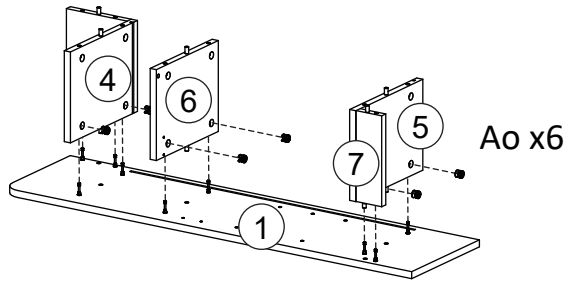

6



N		x2
Ao		x9
Bk-2		x1

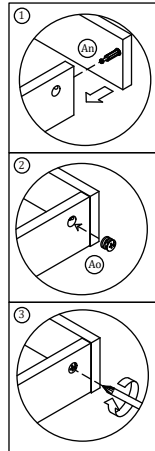
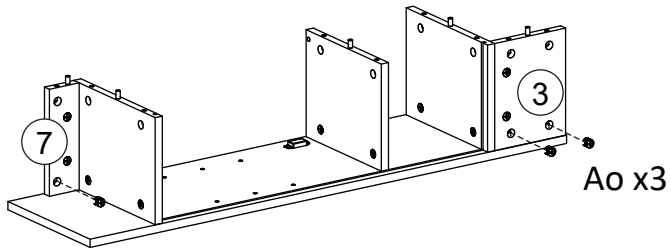
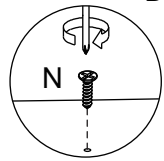
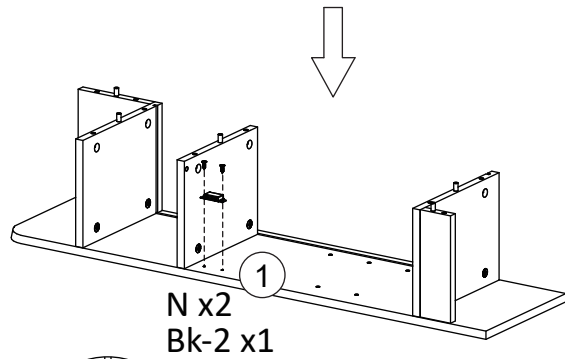

7

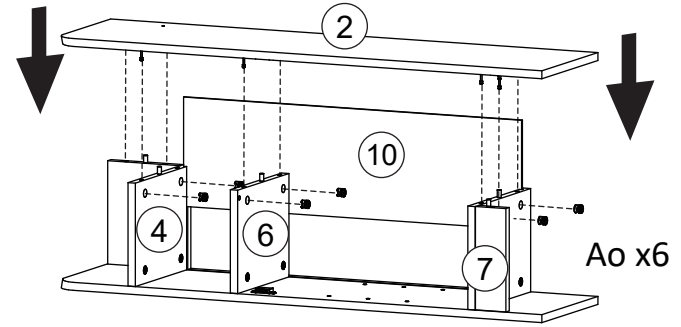

Ao		x9
----	---	----

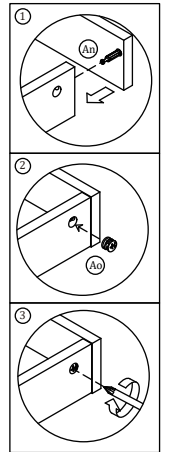
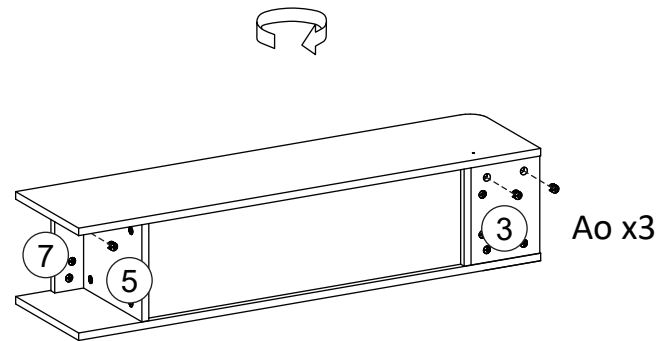
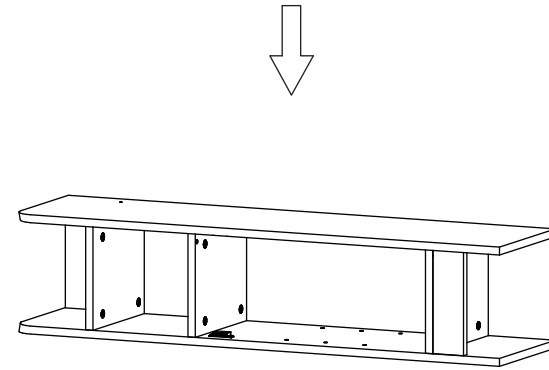

8

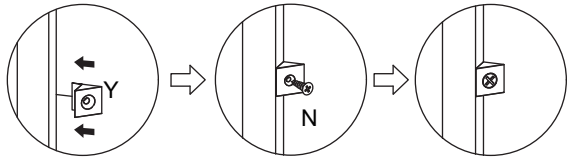
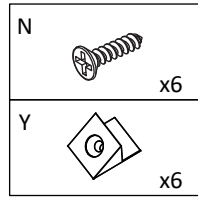
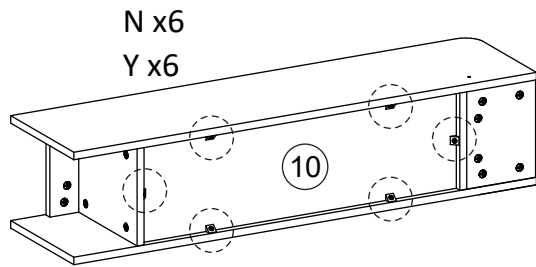

9

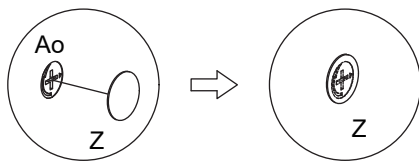
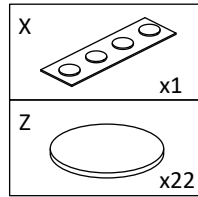
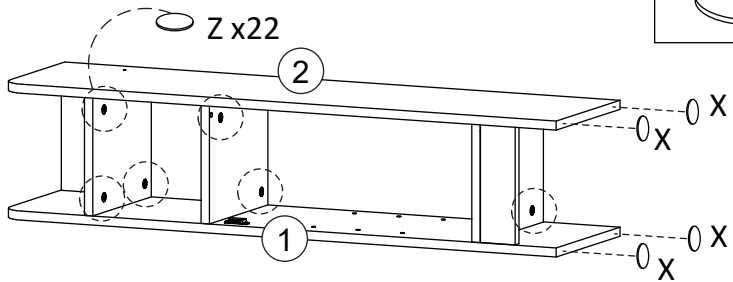

10

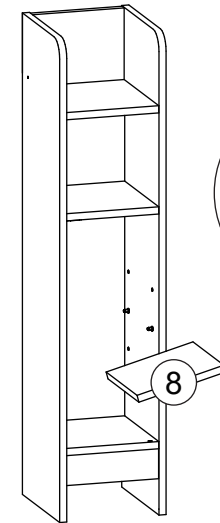
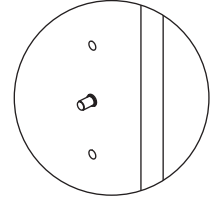
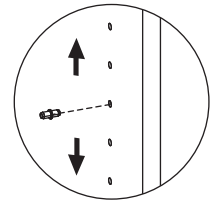
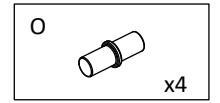
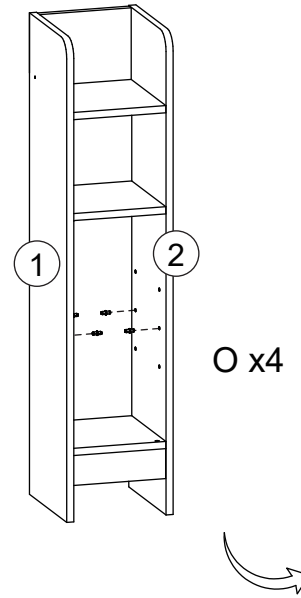

11

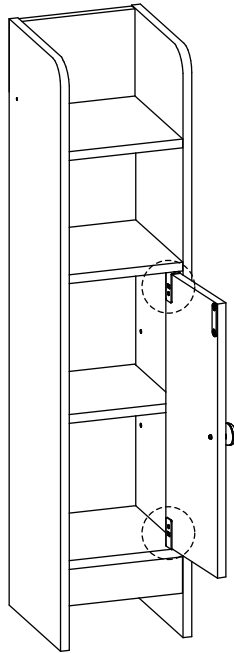

N x4
Es x2

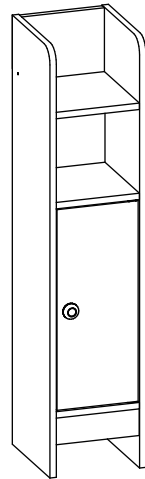
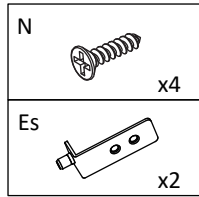
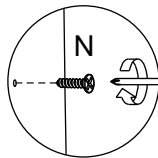

12

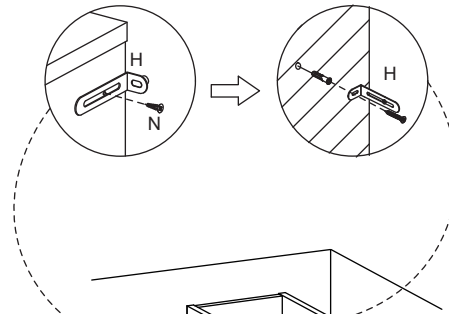

N x2
H x2

