

Assembly Instructions







Your sofa comes packaged in one box. DO NOT use any sharp object to open plastic wrapped components, as damage to product or components may result.

Carefully remove all of the components from the packaging and set aside for assembly.

Assemble on a soft surface to prevent scratching the finish.

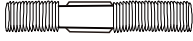
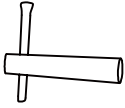
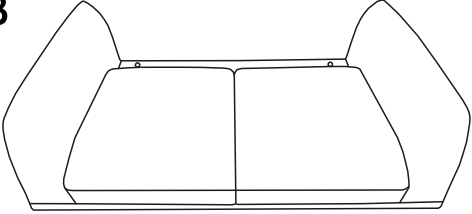
Your sofa style may differ from images. Care for your furniture by periodically tightening all legs. Fabric will fade or discolor in direct sunlight.

Minimize exposure to direct sunlight to extend the life of your furniture.

A  1 PC	C  4 PCS	E  M8*80mm 4 PCS	G  1 PC	
B  1 PC	D  4 PCS	F  30mm 4 PCS	H  15mm 4 PCS	L  M8 4 PCS

Step 1

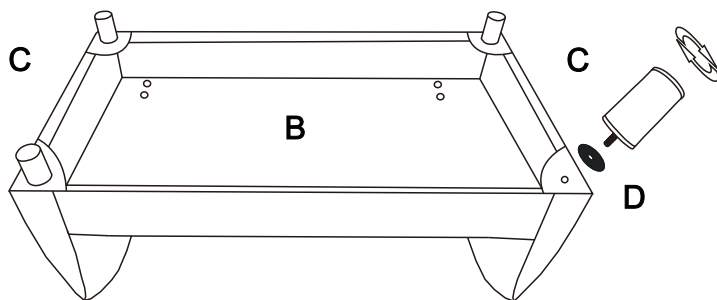

Step 2

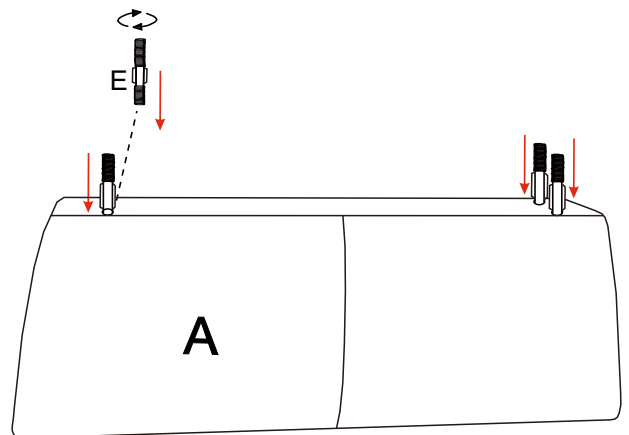

PLEASE READ "VELVET MAINTENANCE INSTRUCTIONS" BACK SIDE IF THE PRODUCT YOU BUY IS IN VELVET FABRIC

Step 3

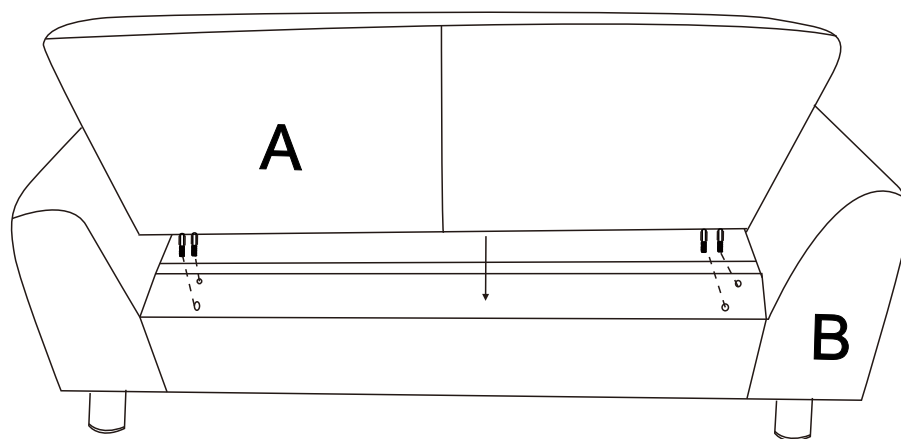

Step 4

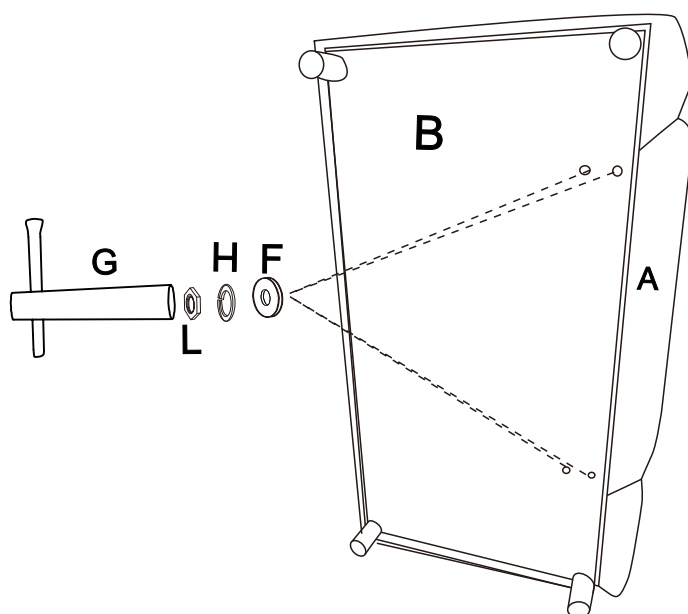

Step 5

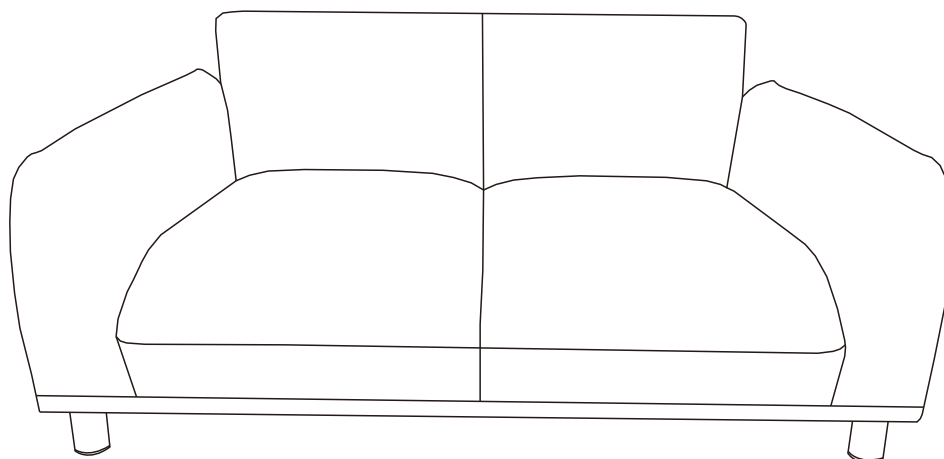

Your item is upholstered in soft plush velvet fabric, and must be brushed once the packaging is removed to get rid of any creases and give the fabric a smooth look.

Pressure marks may occur on velvet items due to the nature of the pile. The pile of velvet reflects the light in different directions, which gives it its characteristic soft look and sheen.

Pressure marks occur when the pile is compressed in one direction, which causes the light to reflect differently and can create visible marks on the surface of the velvet. These marks often look more dire than they actually are and will typically come off on their own with time, or can be removed by steam ironing or brushing.

BRUSHING:

We recommend to purchase a soft velvet fabric brush which will help to maintain your furniture and keep the fabric in excellent condition. You can use a different brush with soft bristles, but please do not use a brush that has stiff bristles as this may damage the fabric (avoid plastic, hard, thick, animal hair bristles). To brush the item, you must determine which way the fabric fibres are woven, and then brush the item following this direction.

STEAM IRONING INSTRUCTIONS:

To steam iron the mark, you can either use a regular iron or a hand steamer. Bring your appliance of choice 20-30 cm away from the mark to slightly increase the temperature of the fabric surface, and then gently steam the surface the mark is on. The fabric should never be hot, and to prevent heating, you can start steaming from further away on lower setting and increasing this as needed, or put neutral-coloured towel on top of the mark to give extra protection. Once the pile relaxes, please brush the mark while steam ironing with a soft brush in the direction of the pile and after finishing the steam ironing process brush through again.

DAILY CARE AND MAINTENANCE

Vacuum your velvet items regularly using a soft brush attachment to remove any dust, dirt, or debris that may accumulate on the surface. Avoid using a beater bar or any attachments that may damage the pile of the velvet. Avoid wetting the pile directly to prevent clumping. Avoid exposing your velvet items to direct sunlight or heat sources, as this can cause fading or discoloration over time. Additionally, avoid placing sharp or pointed objects on the surface of the velvet, as this can damage the pile.

STAIN REMOVAL

Blot up spills immediately with a clean, dry cloth. Do not rub the stain, as this can cause it to spread. For stubborn stains, you can use a specialized velvet cleaner designed specifically for use on polyester velvet items. Always test any cleaning product on a small, inconspicuous area of the item before applying it to the entire surface. After cleaning a stain, be sure to condition the velvet material to keep it soft and supple.

DIRT MARK REMOVAL INSTRUCTIONS:

Please use lukewarm or room temperature water and add a few drops of washing up liquid. Stir with fast motions to make a foam and use ONLY the bubbly foam to clean the velvet upholstery. Blot the stain gently using a white cleaning cloth. Keep blotting until it is no longer visible. Now leave the upholstery to air and dry. After it has dried out completely, use a vacuum to clean the surface to make it look smooth and make sure the spot blends in with the rest of the velvet sofa.