

Sleeper Sofa

Owner's Manual

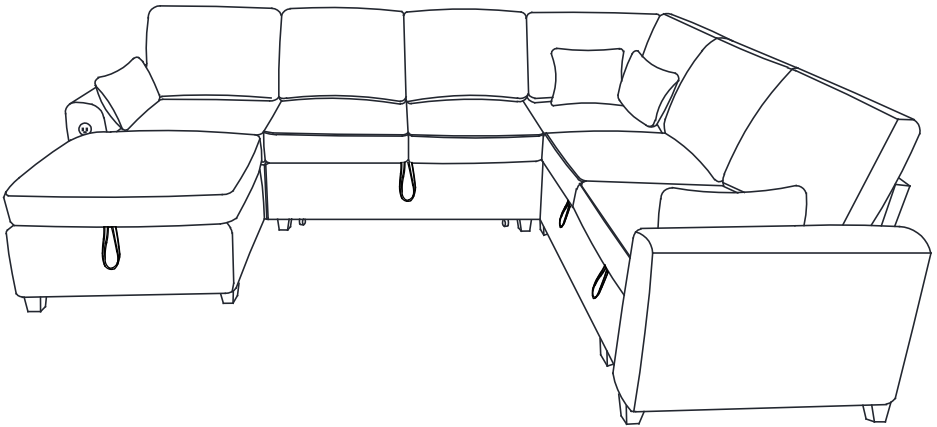

FAQ :

Q1:Missing parts when received.

A1:If you find some parts are missing from the box, please kindly send us messages to let us know the name of missing part regarding of the parts list of the instuction, we will send you the replacement asap.

Q2: Assemble Diffcult.

A2:It is best for two people to install the sofa. If there are any problems during the installation process, you can take photos and send them to us, and we will reply promptly. There are also installation videos on our Amazon page that you can view online.

Q3:Some parts damaged when arrived.

A3:Please send us the clear photo about damaged part to us as attachment, we will check and offer you the best solution soon.

Q4:Only received one box.

A4:We normally ship all the boxes on the same day, but the boxes may be not delivered togther because of carrier.The delivery time interval between two packages will not exceed two days normally.And you can also contact seller and ask for the delivery time of other box.

Q5:Want to return the product.

A5:Before returning the item, please contact us about return issue, please make sure that the box packaging is complete, the product is not damaged, stained and not affecting secondary sales. Return product that do not use the original packaging may be rejected, and the pictures may be requested to offer online.

Important Caution

Before beginning assembly of the product, make sure all parts are present. Compare parts with the package contents list and hardware contents. If any part is missing or damaged, do not attempt to assemble the product. If any part is missing or damaged, please contact customer service.

- Some parts may contain sharp edges. Wear protective gloves if necessary during assembly.
- When using power tools, please start with the minimum power setting to avoid potential damage to the parts.

Safety Guide

- For your safety and to reduce the risk of severe personal injury, the user must read and understand this Safety Guide.
- Assemble each piece only by following the instructions. Using tools or hardware not included in the original packaging, or improper assembly may cause the product to malfunction or create a risk of severe personal injury.
- Assemble on a flat and soft surface, such as carpeting, to avoid scratches or damage.

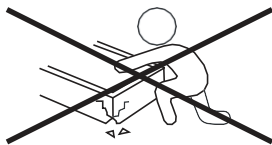

NOTICE

- Tighten all bolts and screws again within the first two weeks of assembly.
- Check the tightness of all bolts every two months; tighten them if necessary.

Care & Maintenance

- Fluff cushions regularly to maintain their shape and loft.
- Vacuum crevices weekly using a soft brush attachment to prevent dust and soil from settling into the fabric.
- Keep furniture out of direct sunlight and away from heat sources to prevent fading and deterioration.
- Spills should be wiped up immediately. Blot (do not rub) spills promptly with a clean, colorfast, absorbent cloth.
- Always pre-test cleaning agents in a small, inconspicuous area first.

Read & Save These Instructions Before Assembly

- Please separate and identify all parts, making sure you have all parts listed.
- To avoid scratches during assembly, please assemble on a soft mat or similar surface.
- Please assemble step by step and follow the instructions.
- Washers must be used.
- Do not fully tighten each screw and nut until all screws are properly aligned.

Read & Save These Instructions Before Assembly





- Two adults are required for safe assembly.



Quick Start Guide

Box Checklist

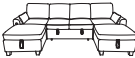
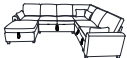
Find your variant & check boxes. Different variants ship with different boxes. Before assembly, confirm you've received all boxes. If any box or part is missing or damaged, please contact us by email or through the platform and we'll help right away.

Model Variant		Box Delivery Checklist	Key (Parts List)	
2 Seat Sleeper		G + J	Box F	2 Seat Storage Module
3 Seat Sleeper		G + I + J	Box G	2 Seat Sleeper Module (Pull out)
5 Seat Sleeper		F + G + H + J	Box H	Corner Seat Module
6 Seat Sleeper		G + I + I + J	Box I	Single Seat + Ottoman Module
7 Seat Sleeper		F + G + H + I + J	Box J	Armrests (Left & Right, as a pair)
8 Seat Sleeper		F+G+G + H+H+ J		

Cushion Decompression

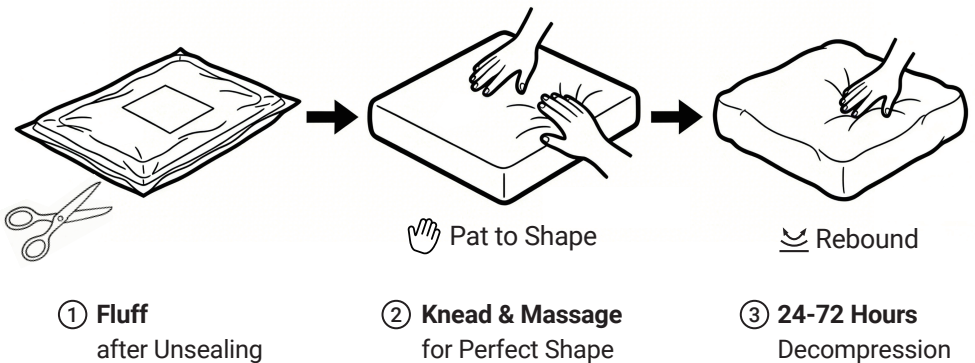

The connector tabs come pre-installed on the sofa. For different layout options, you may need to replace them during assembly. All parts are included (plus an extra pair). See the diagrams below for replacement steps.

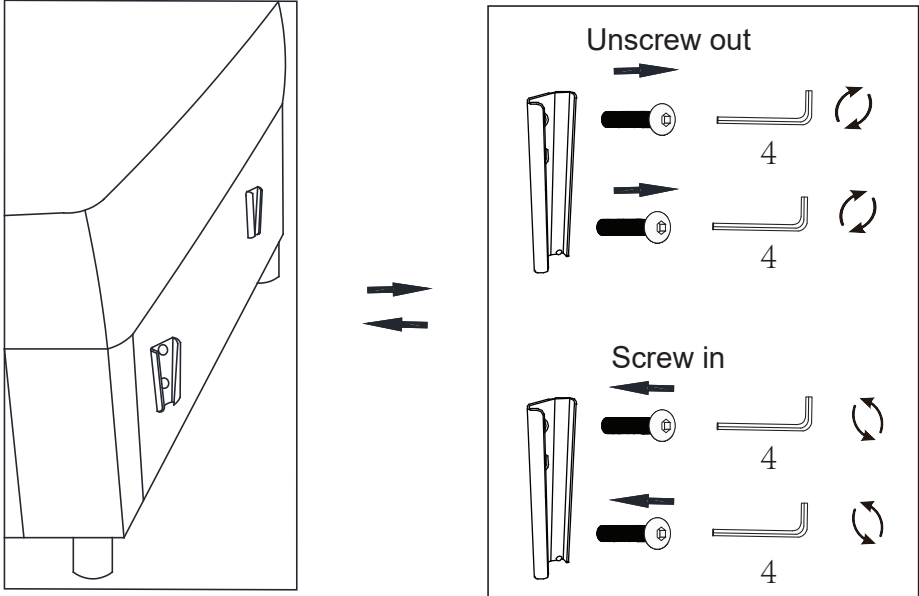

RETURN ISSUE











We offer 30-day returns, please feel free to contact us.









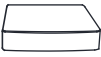

Return requirements:

1. Original carton in good condition
2. No damage to the product















Contact Customer Service Team

Parts List















Carton	Part				Hardware			
BOX F (Part B and Part L are vacuum-packed together)	A	Loveseat frame		1PC	1	Washers	 8*22mm	16PCS +1PC
	B	Seat cushion		2PCS	3	Screws	 M8*25mm	16PCS +1PC
	C	Backrest		2PCS	4	Alley key		1PC
	L	Back cushion		2PCS				
	R	Supporting feet		4PCS				
	S	Gaskets		4PCS				
	Q	metal backrest tubes		4PCS				









Carton	Part				Hardware			
BOX G (Part B and Part L are vacuum-packed together)	B	Seat cushion		2PCS	1	Washers	 8*22mm	16PCS +1PC
	C	Backrest		2PCS	2	Screws	 M6*16mm	8PCS +1PC
	L	Back cushion		2PCS	3	Screws	 M8*25mm	16PCS +1PC
	Y	Pull out Bed frame		1PC	4	Alley key		1PC
	P	Wheels		4PCS				
	Q	metal backrest tubes		4PCS				

Parts List

Carton	Part				Hardware			
BOX H	D	Corner seat frame		1PC	1	Washers	 8*22mm	16PCS +1PC
	I	Corner cushion		1PC	3	Screws	 M8*25mm	16PCS +1PC
	H	Corner backrest		2PCS	4	Alley key		1PC
	M	Corner left back cushion		1PC				
	N	Corner right back cushion		1PC				
	O	Pillows		2PCS				
	R	Supporting feet		4PCS				
	S	Gaskets		4PCS				
	W	Connector tabs		2PCS				
	X	Connector tabs		2PCS				
	Q	metal backrest tubes		4PCS				

Parts List

Carton	Part			Hardware				
BOX I (Part B and Part L are vacuum-packed together)	B	Seat cushion		1PC	1	Washers	 8*22mm	8PCS +1PC
	C	Backrest		1PC	3	Screws	 M8*25mm	8PCS +1PC
	E	Single seat frame		1PC	4	Alley key		1PC
	F	Ottoman frame		1PC				
	G	Ottoman cushion		1PC				
	L	Back cushion		1PC				
	R	Supporting feet		8PCS				
	S	Gaskets		8PCS				
	W	Connector tabs		2PCS				
	X	Connector tabs		2PCS				
	Q	metal backrest tubes		2PCS				

Carton	Part			Part				
BOX J (Hardware stored in armrests, 2 pillows vacuum-packed together.)	J	Left armrest		1PC	W	Connector tabs		2PCS
	K	Right armrest		1PC	X	Connector tabs		2PCS
	O	Pillows		2PCS				
	R	Supporting feet		4PCS				
	S	Gaskets		4PCS				
	Z	Plug		1PC				

Assembly Instructions

- Start the installation only after all corresponding boxes have been received.
- The installation steps vary depending on the different combinations.

2 Seats Include 2 Box: **Box G** + **Box J**

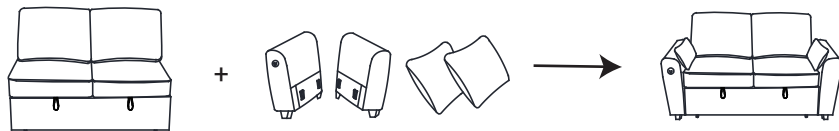

3 Seats Include 3 Box: **Box G** + **Box I** + **Box J**

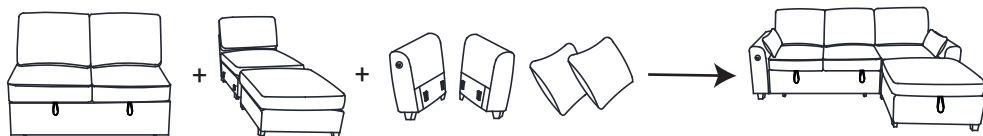

5 Seats Include 4 Box: **Box F** + **Box G** + **Box H** + **Box J**

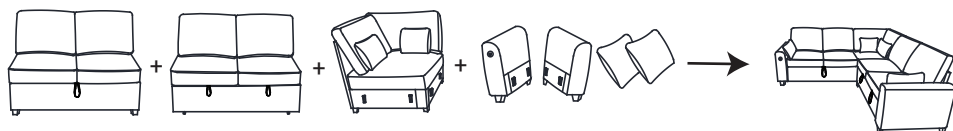

6 Seats Include 1 Box: **Box G** + **Box I** + **Box I** + **Box J**



7 Seats Include 5 Box: **Box F** + **Box G** + **Box H** + **Box I** + **Box J**

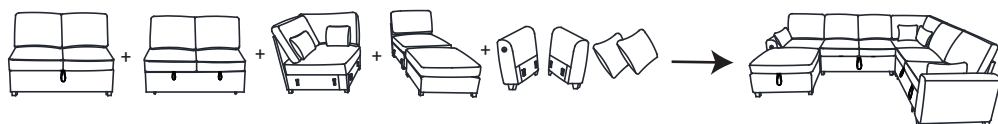

8 Seats Include 6 Box: **Box F** + **Box G** + **Box G** + **Box H** + **Box H** + **Box J**

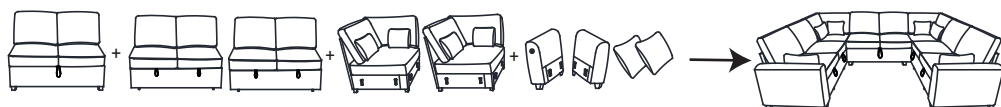

Box F

1 Install Sofa Legs.

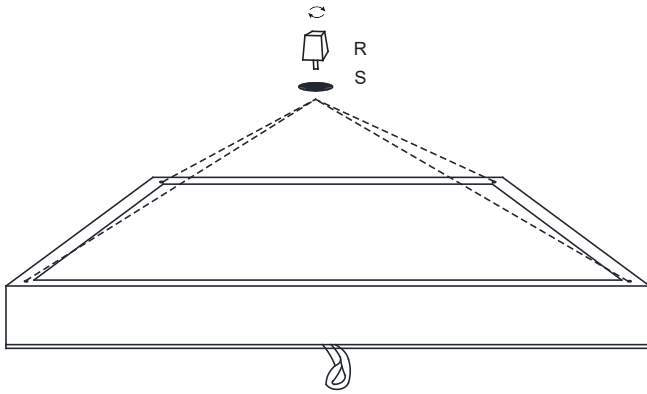

Box F

2 Install metal backrest tubes.

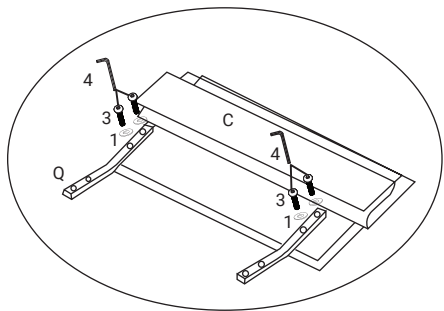
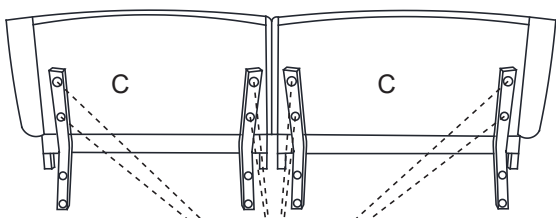
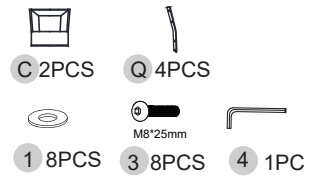

Box F

3 Connect the backrest to the seat frame.

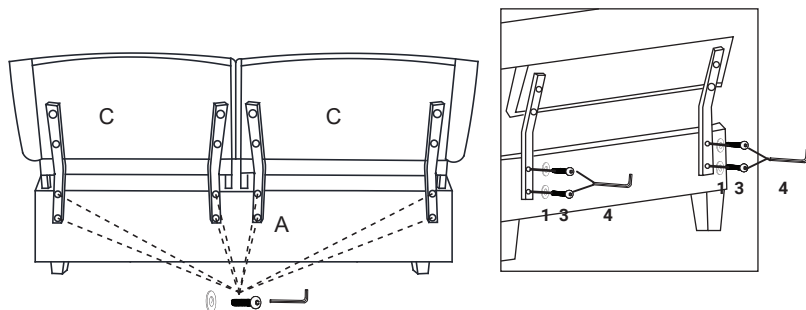
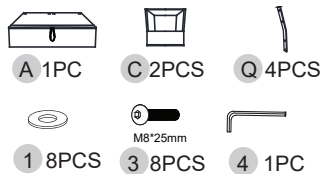

After the screw which connected to the seatframe is tightened to 100%, the screw from the previous step is also tightened to 100%.

Box F

4

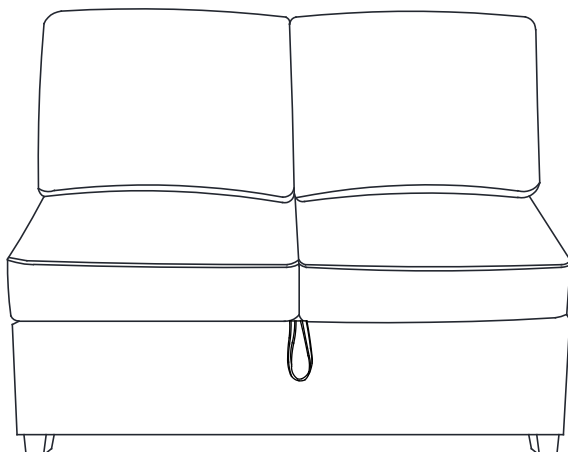

Box G

1 Install wheels on pull-out bed.

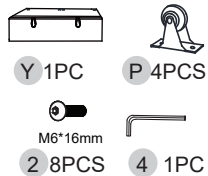
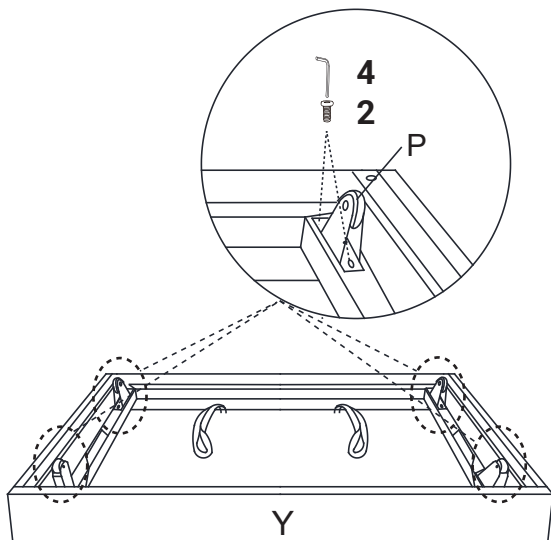

Box G

2 Install metal backrest tubes.

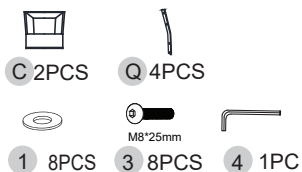
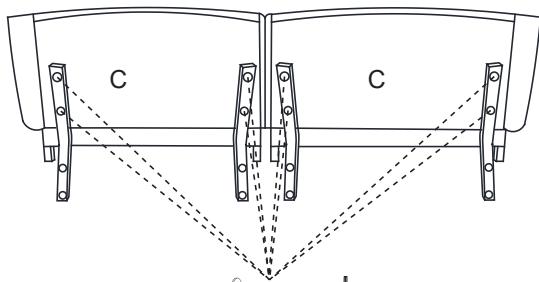

1 3 4

(tighten 80%)

Box G

3 Connect the backrest to the seat frame.



Y 1PCS



C 2PCS



Q 4PCS



1 8PCS



3 8PCS



4 1PC

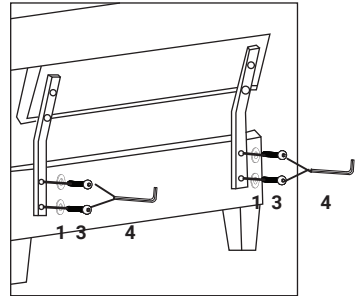
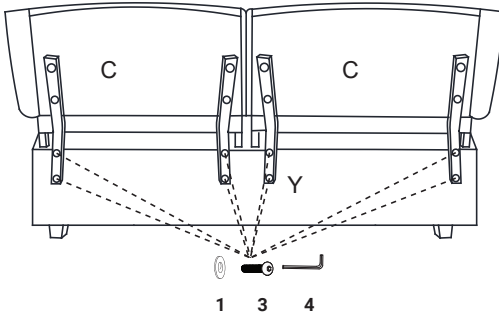

After the screw which connected to the seatframe is tightened to 100%, the screw from the previous step is also tightened to 100%.

Box G

4

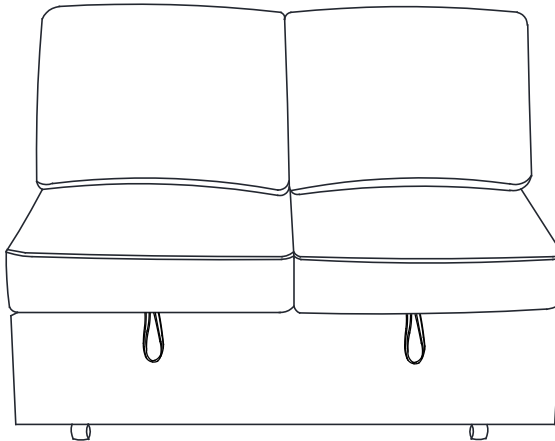

Box H

1 Install Sofa Legs.

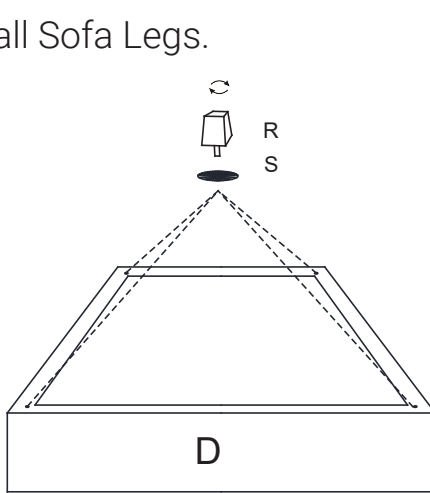

D 1PC



R 4PCS



S 4PCS

Box H

2 Install metal backrest tubes.

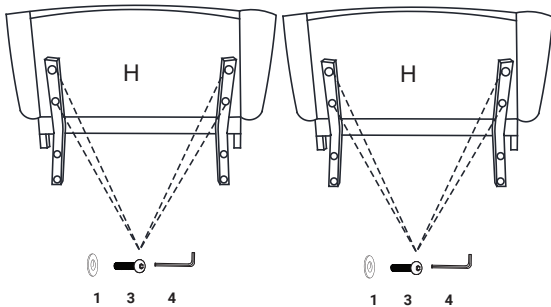

H 2PCS



Q 4PCS



1 8PCS



M8*25mm
3 8PCS



4 1PC

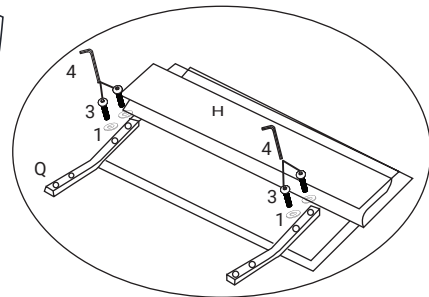

(tighten 80%)

Box H

3 Connect the backrest to the seat frame.

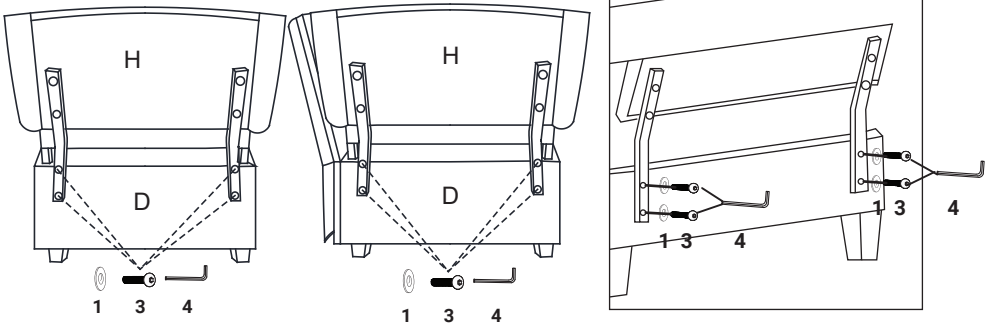
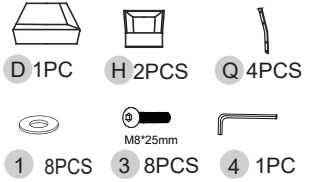

After the screw which connected to the seatframe is tightened to 100%, the screw from the previous step is also tightened to 100%.

Box H

4

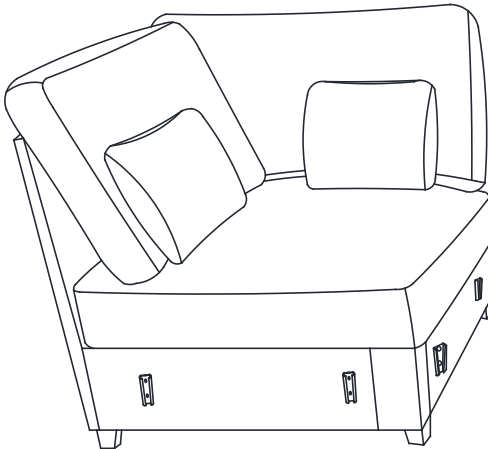

Box I

1 Install Sofa Legs.

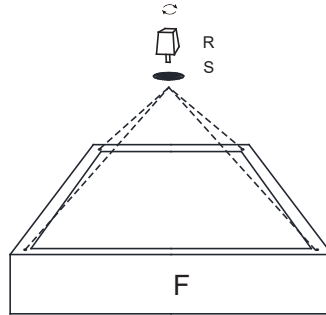
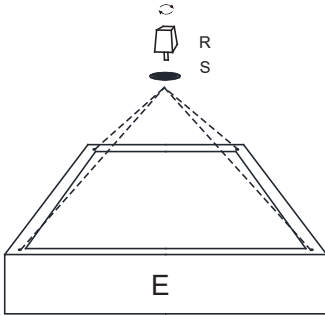
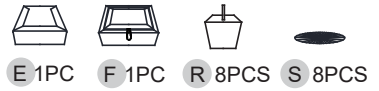

Box I

2 Install metal backrest tubes.

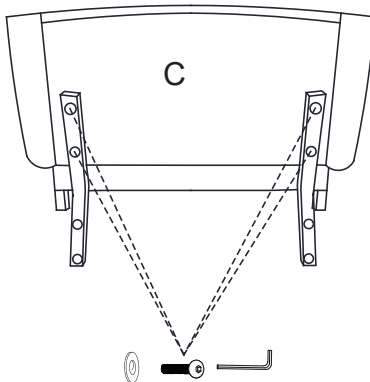
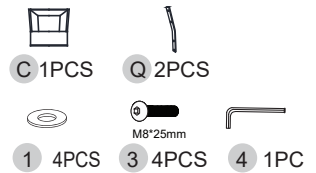

1 3 4

(tighten 80%)

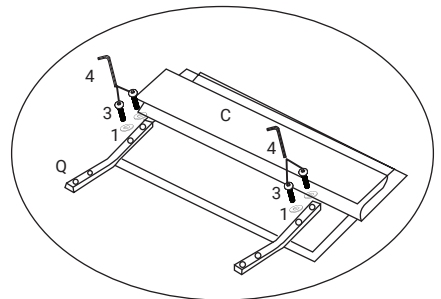

Box I

3 Connect the backrest to the seat frame.

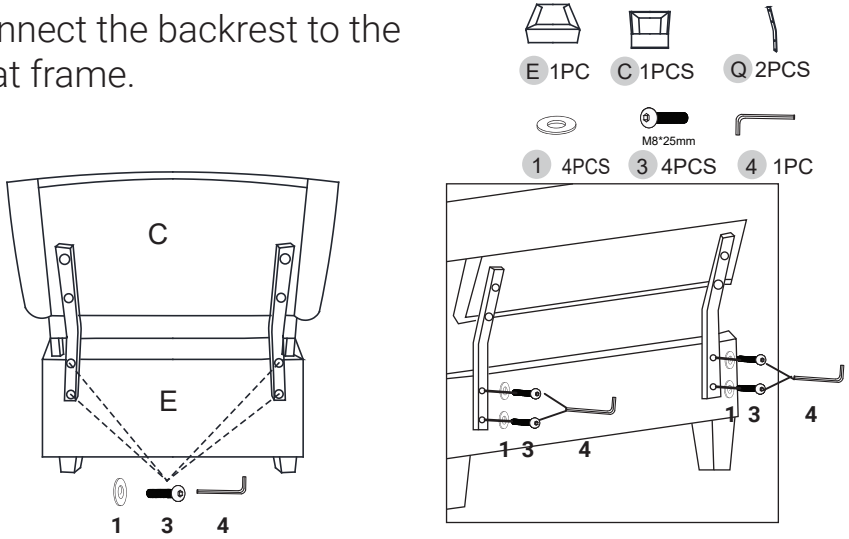

After the screw which connected to the seatframe is tightened to 100%, the screw from the previous step is also tightened to 100%.

Box I

4

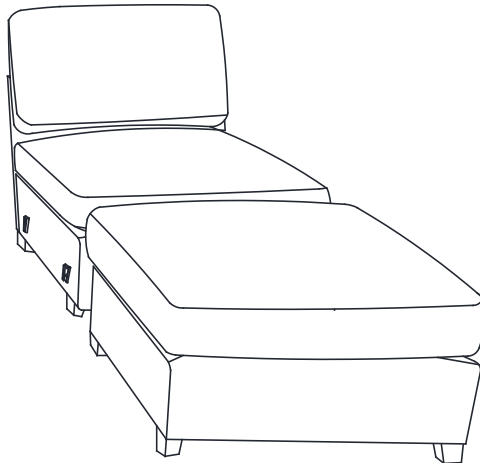

Box J

1 Installing sofa legs:

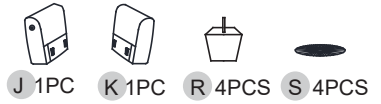

- 1.Remove partO, partR, partS and partZ from armrest:
- 2.Power cord under armrest (zipper). Unzip and connect.

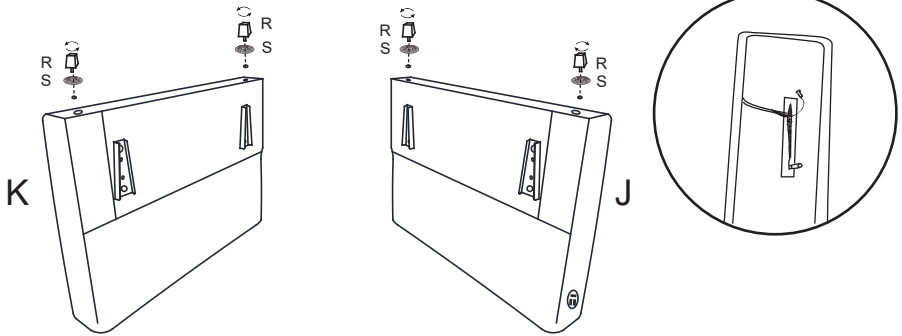

Box J

2

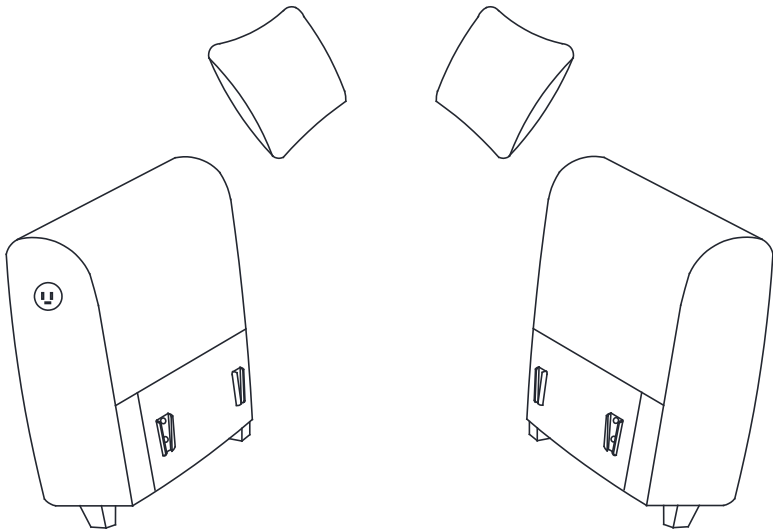

1 Before using storage, remove seat cushion, then open storage lid.

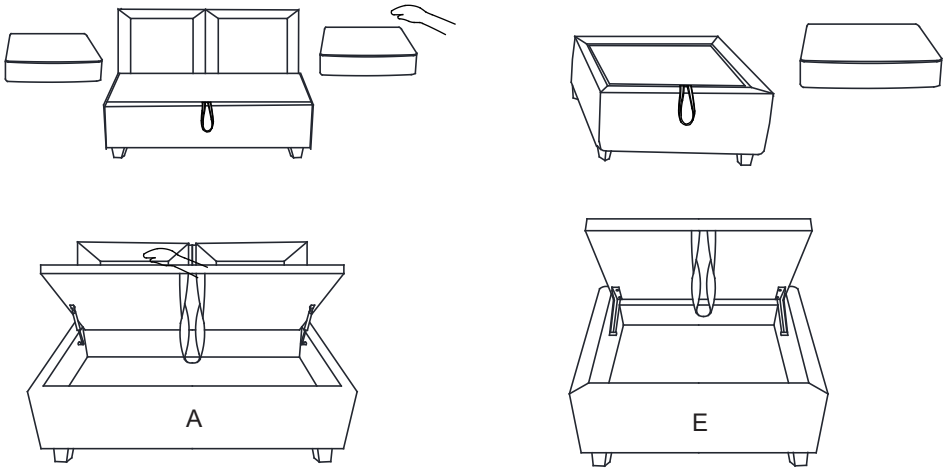

2 Connect each assembled component using the insert plates.

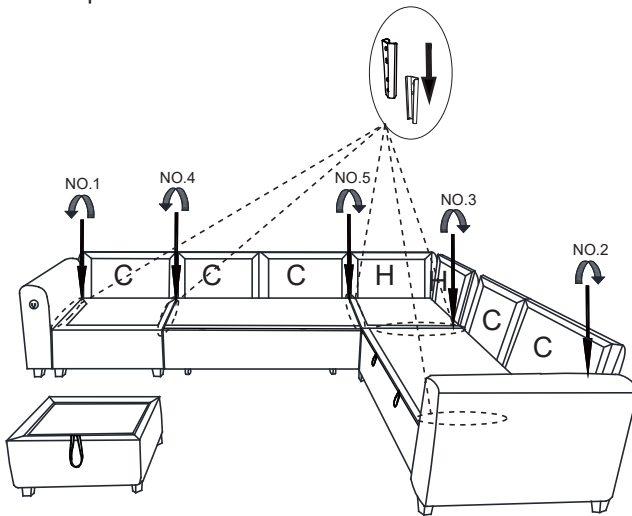

1

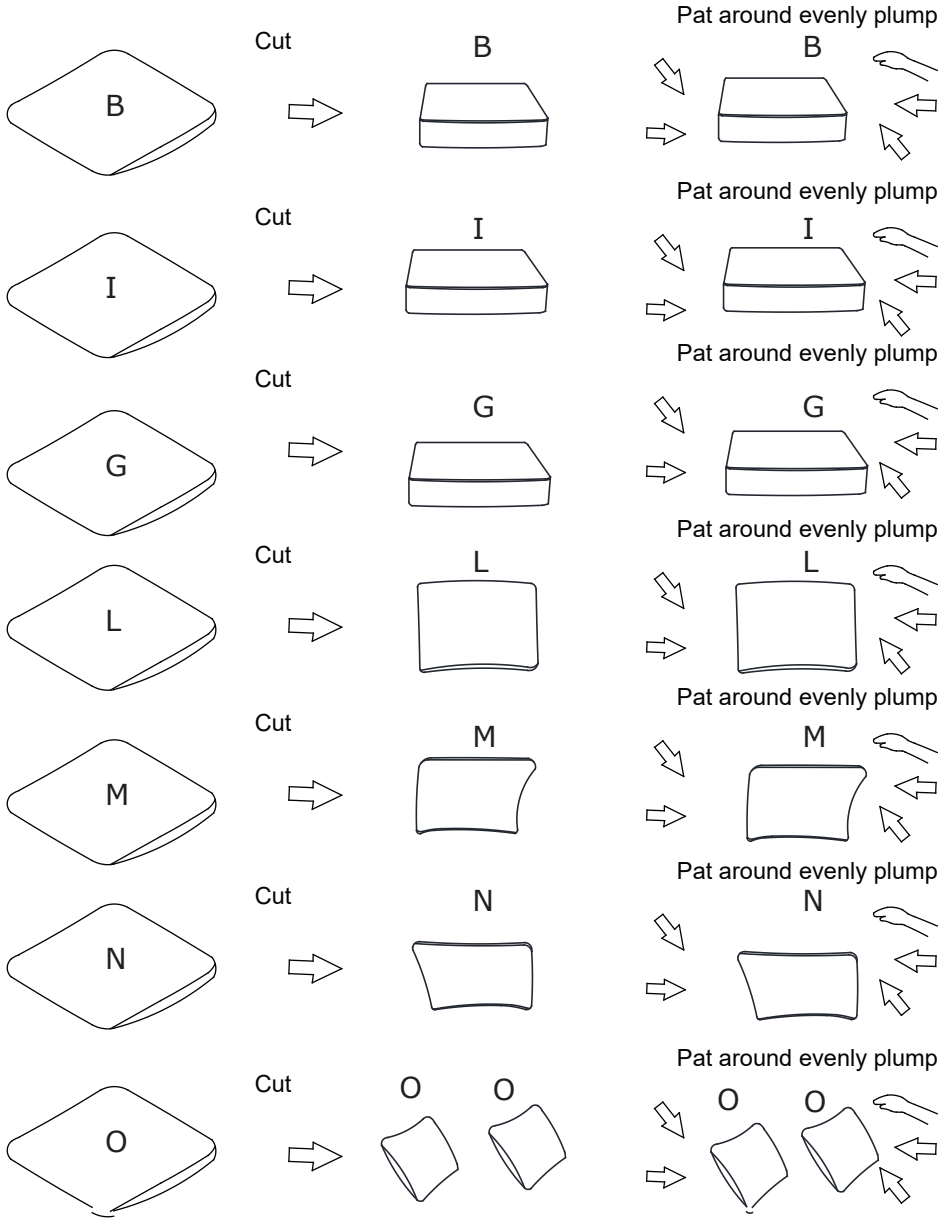

2

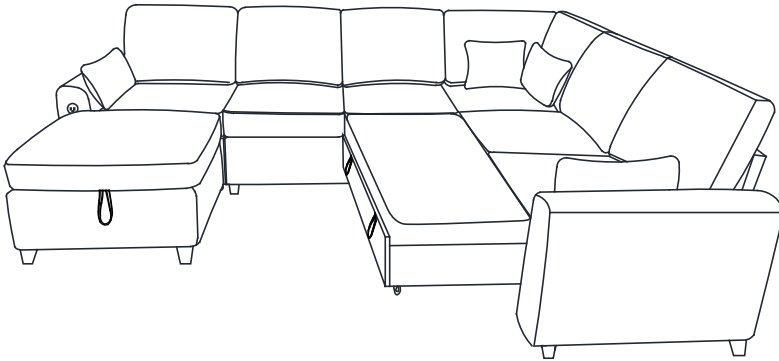
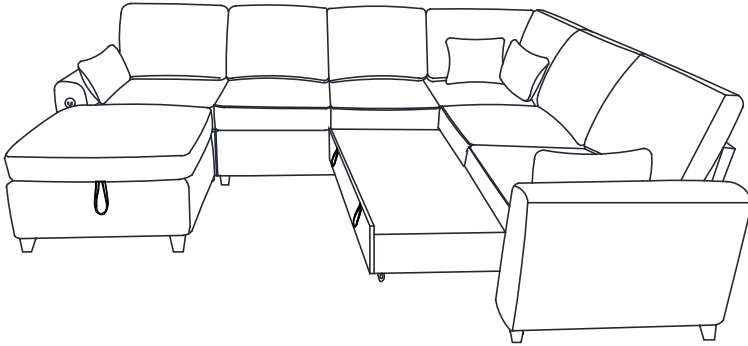
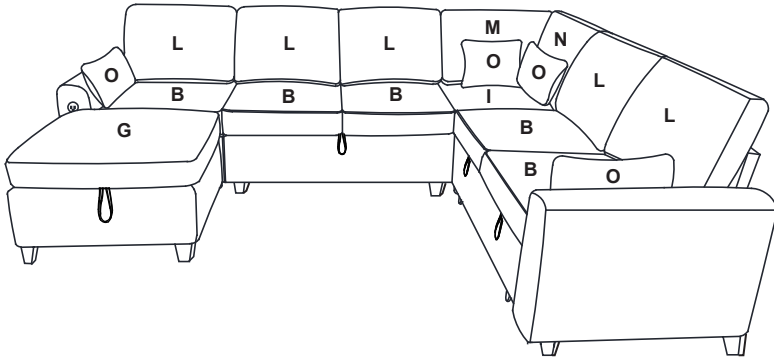

2 Seat Sleeper
Boxes:G+J

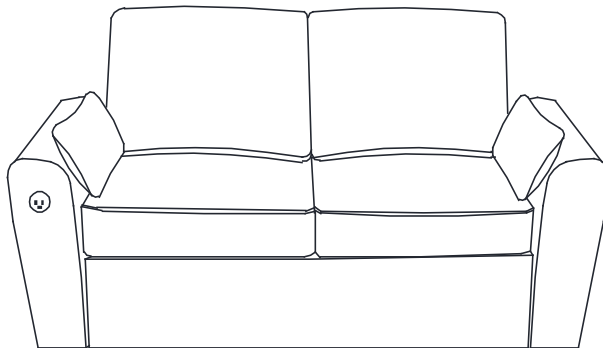
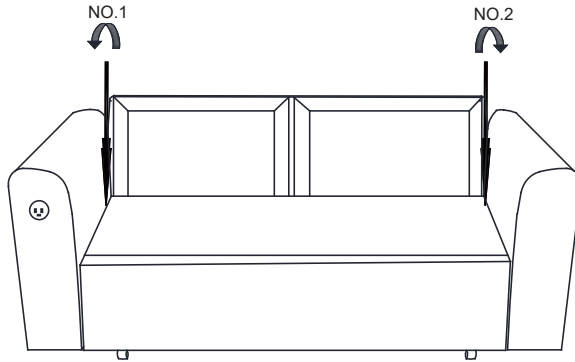

3 Seat Sleeper Boxes:G+I+J

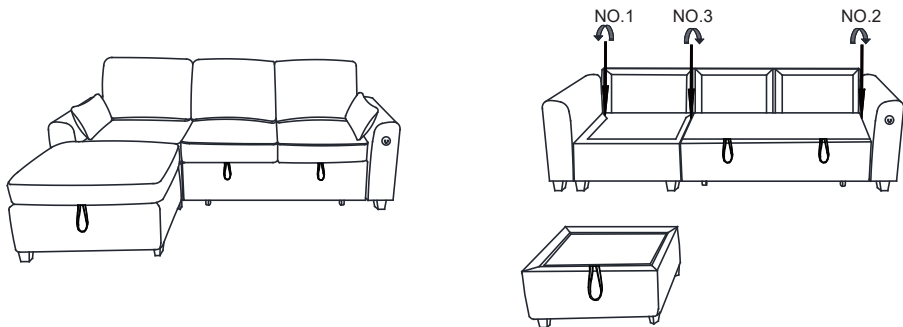

If you want to adjust the placement of the single seat and footrests, you can swap the connector tabs on the single seat to complete the installation.

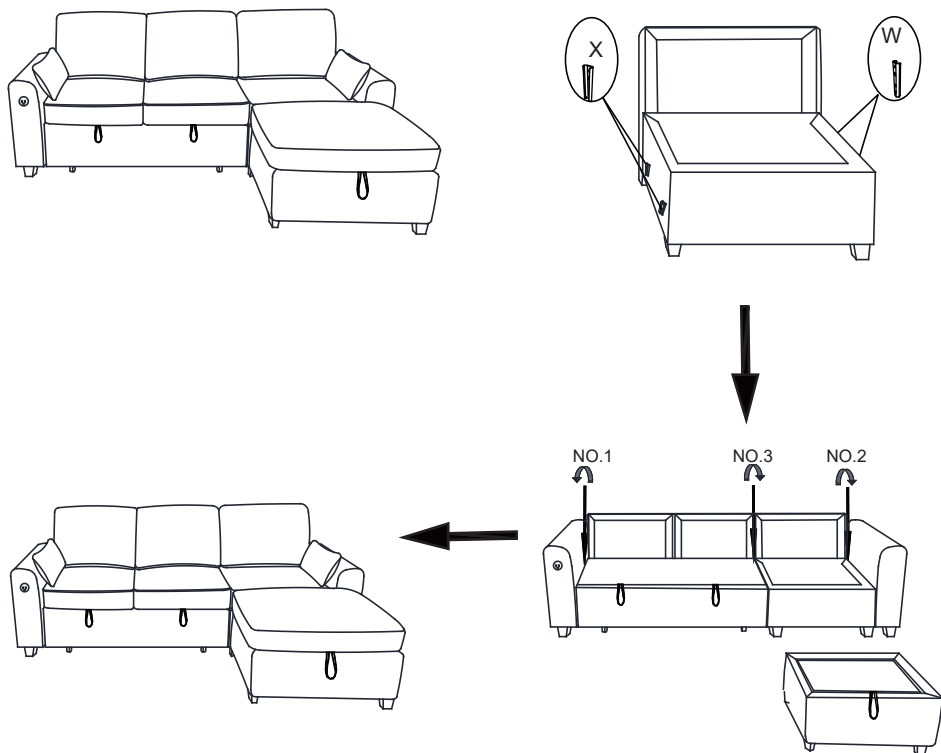

5 Seat Sleeper Boxes:F+G+H+J

Replace the connector tabs on the corner seat shown in the diagram with Model X to complete the installation.

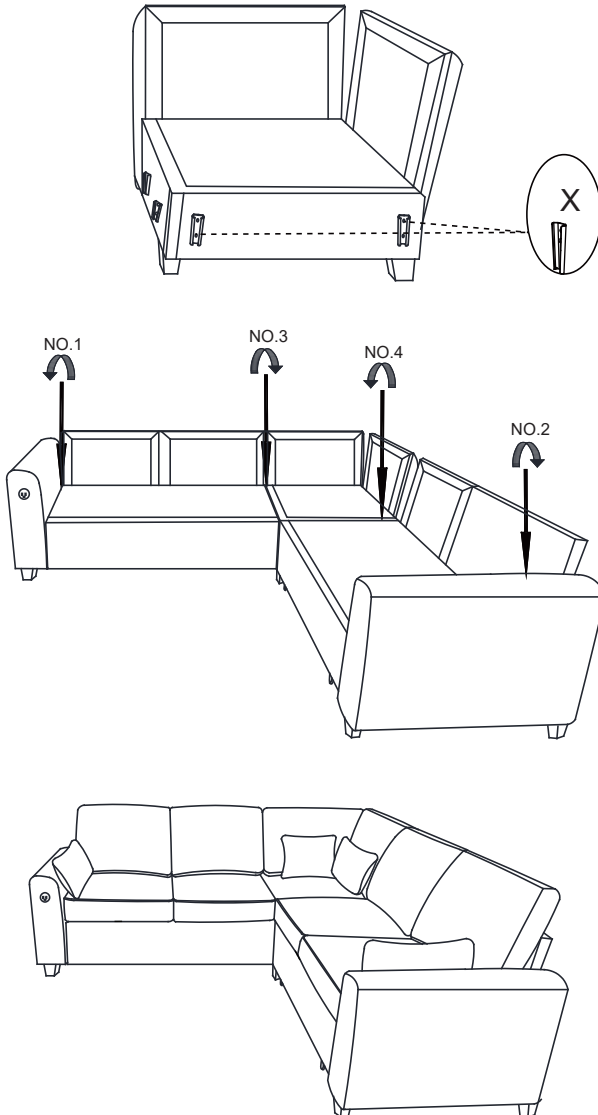

6 Seat Sleeper Boxes:G+I+I+J

Swap the connector tabs on the single seat shown in the diagram to complete the installation.

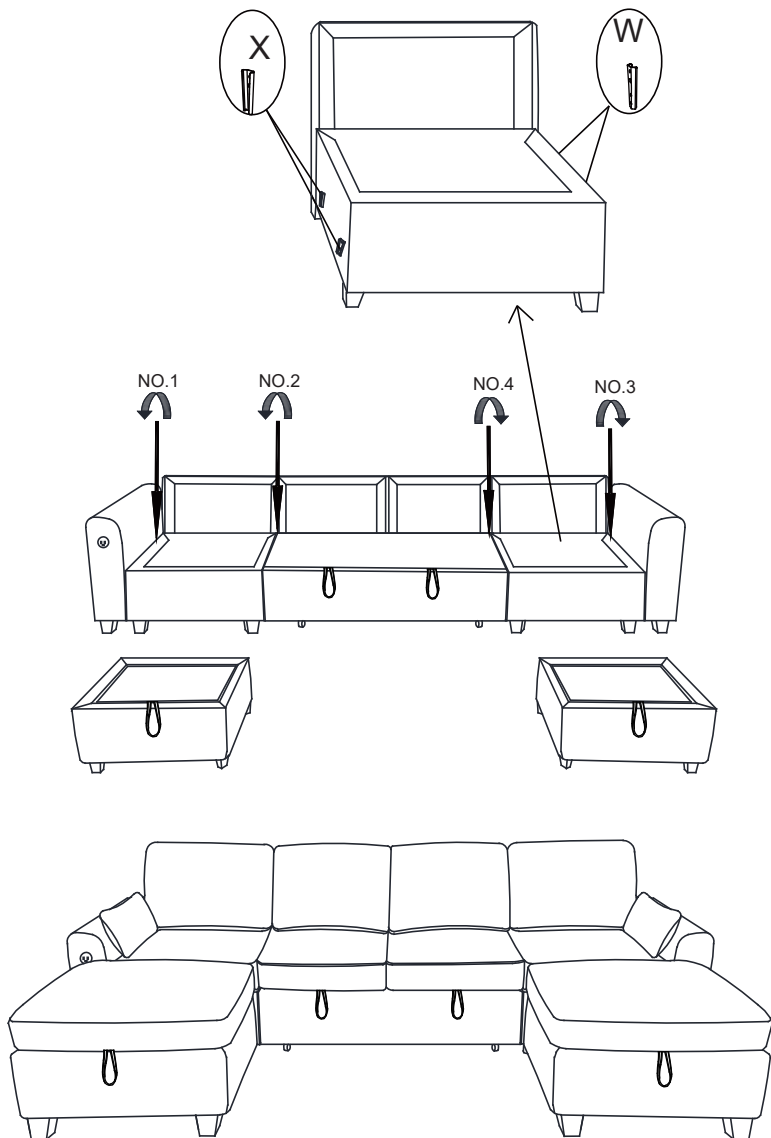

8 Seat Sleeper Boxes:F+G+G+H+H+J

Replace the connector tabs on the corner seats shown in the diagram with Model X to complete the installation.

