

INSTALLATION MANUAL

SF-002

- 2 HANDRAILS
- OTTOMAN
- ARMLESS CHAIR

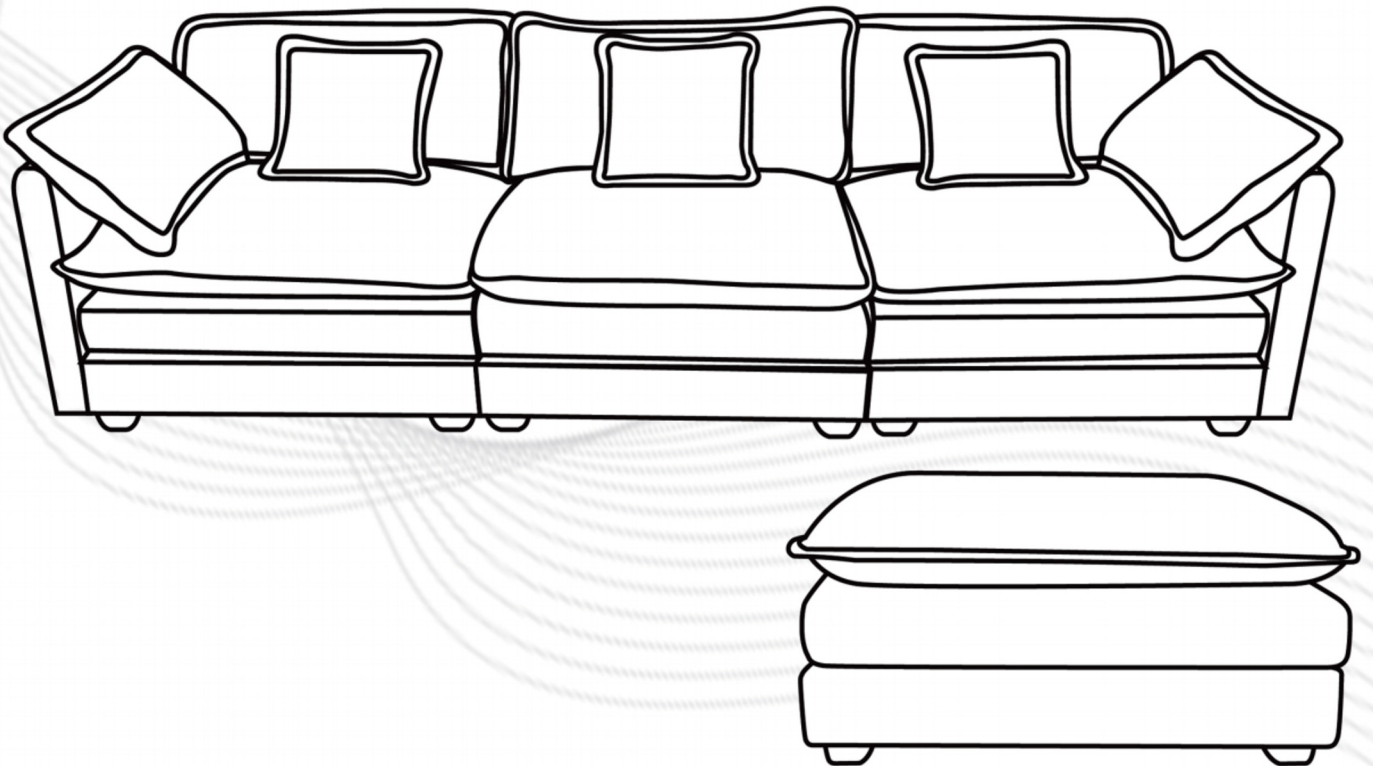



PRE-ASSEMBLY INFORMATION

Please read this manual carefully before beginning assembly of this product.

Keep this manual for future reference.



NOTICE

- Please keep this manual and hand it over when you transfer the product.
- Please read the following instructions carefully and use the product accordingly.
- This summary may not include every detail of all variations and considered steps.
- Please contact us when further information and help are needed.
- Please do not exceed the weight limitations of this item.
- Do not stand on or use any part of this item as a step ladder. If any parts are missing, broken, damaged, or worn, stop using this item until repairs are made and/or factory replacement parts are installed.
- Please assemble the item in a spacious room and do not place the unwrapped product directly on the ground to avoid damage.
- Do not use this item in a way inconsistent with the manufacturer's instructions as this could void the product warranty.
- Periodically inspect screw tightness while the product is in use. If necessary, retighten to ensure structural integrity.
- To avoid the potential dangers of suffocation, please keep all parts and packaging (films, plastic bags and foam, etc.) away from children and pets.
- Do not use or store this item in the proximity of open flame or flammable/combustible chemicals.
- Do not expose product to direct sunlight exposure or rain, and do not put it in a humid place. Failure to do so may accelerate the distortion or discoloration.



WARNING

- Do not tighten bolts / screws completely until all bolts / screws are lined up and inserted into holes.
- Do not over tighten screws and bolts to avoid stripping.
- Please use hand tools to assemble this product. If you're using power tools, remember to set the tool to low torque to avoid damage.
- We recommend unpacking and starting assembly of this item when all boxes are received.



CHOOSE YOUR COMBINATION

[There are **6 combinations** here]

This sofa we have a variety of combinations, please check the corresponding installation instructions according to the combination you purchased.

▶ 1 - Seat Sofa

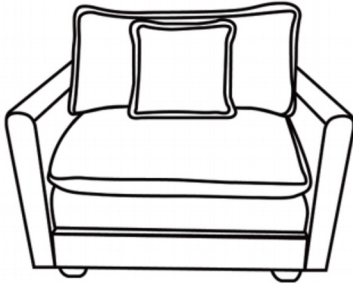

SHIP IN
2
BOX

▶ 1 - Seat with Ottoman

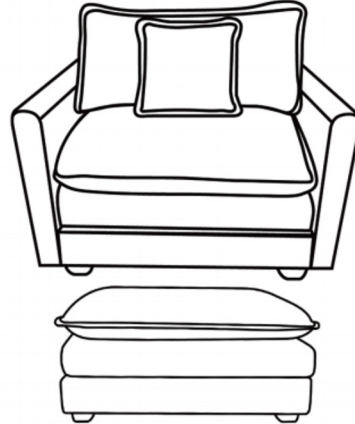

SHIP IN
3
BOX

▶ 2 - Seat Sofa

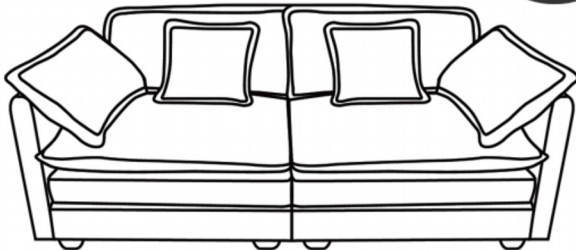

SHIP IN
2
BOX

▶ 2 - Seat with Ottoman



SHIP IN
3
BOX

▶ 3 - Seat Sofa



SHIP IN
3
BOX

▶ 3 - Seat with Ottoman

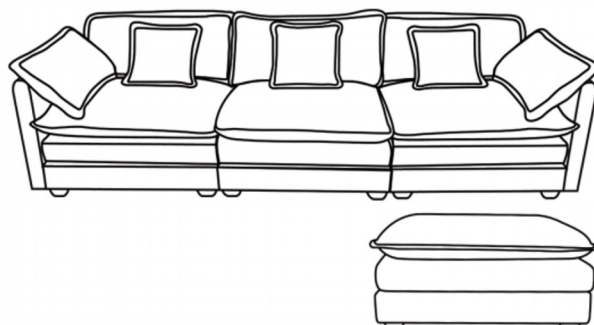

SHIP IN
4
BOX

ASSEMBLY INSTRUCTION (HANDRAILS)

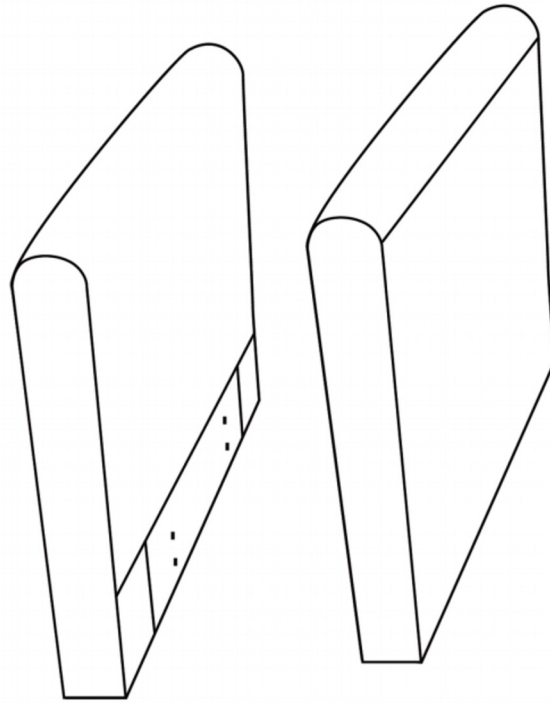

HANDRAILS COMPONENTS

1pc

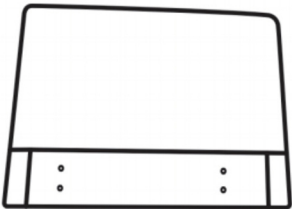

(H) Left Armrest

1pc

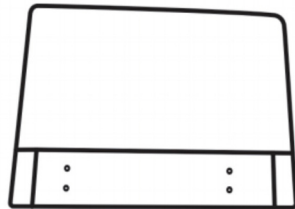

(I) Right Armrest

8pcs+1pc



(O) M6*60mm Bolt

8pcs+1pc



(N) Washer

1pc



(R) Alley Key

Note: Please retain all boxes until you are certain that your product isn't damaged and that you do not wish to return it. Disposal of boxes may prevent our ability to resolve your request.

ASSEMBLY INSTRUCTION (HANDRAILS)

Step 1

Assemble the Left armrest (H) to the Seat frame (A) with Washers (N) and Bolts (O).

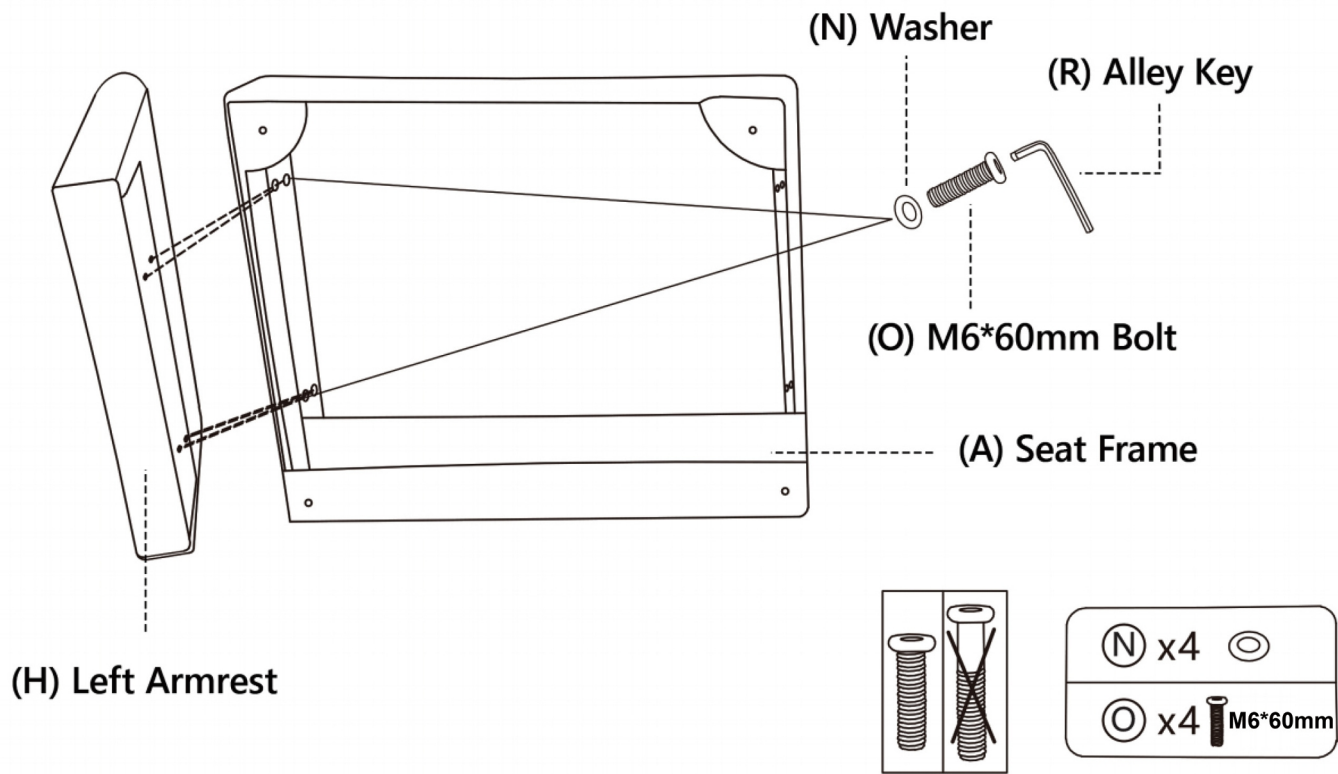

* Note: The Seat frame (A) is inside the box of the Armless Chair.

Step 2

Assemble the Right armrest (I) to the Seat frame (A) with Washers (N) and Bolts (O).

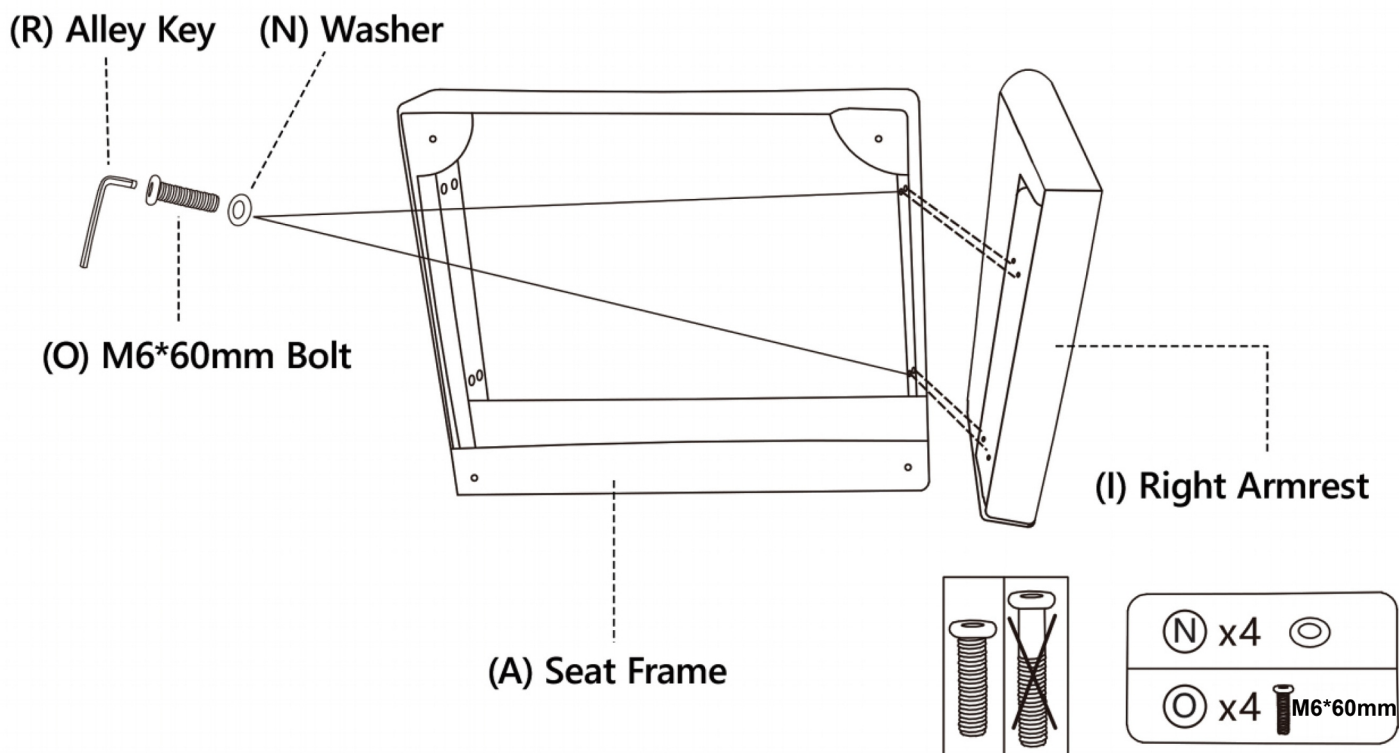

ASSEMBLY INSTRUCTION (OTTOMAN)

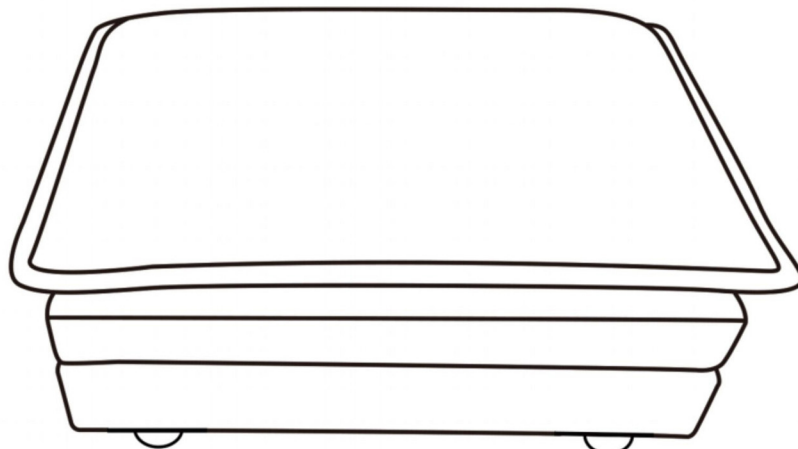

OTTOMAN COMPONENTS

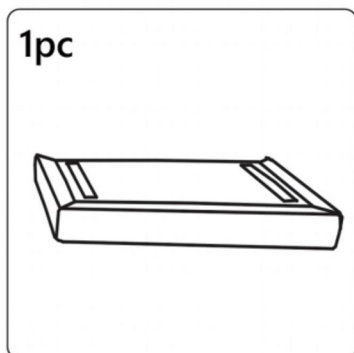

(N) Ottoman Frame

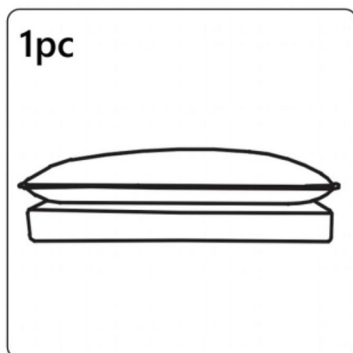

(O) Ottoman Cushion

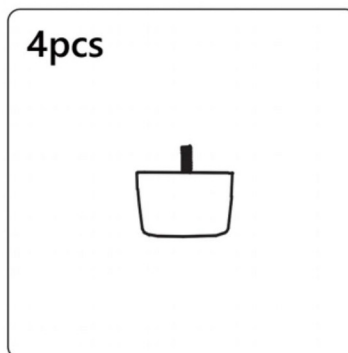

(G) Leg

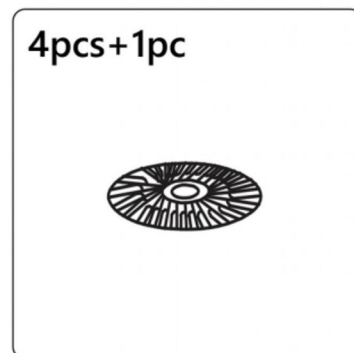

(L) Gasket

Note: Ottoman's Leg is zippered open at the bottom in accessory N. Look carefully!

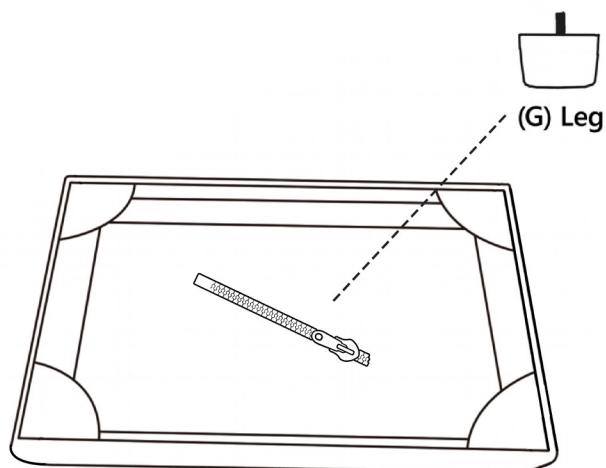

(N) Ottoman Frame

ASSEMBLY INSTRUCTION (OTTOMAN)

Step 1

Assemble the Legs (G) on the ottoman frame with Gaskets (L).

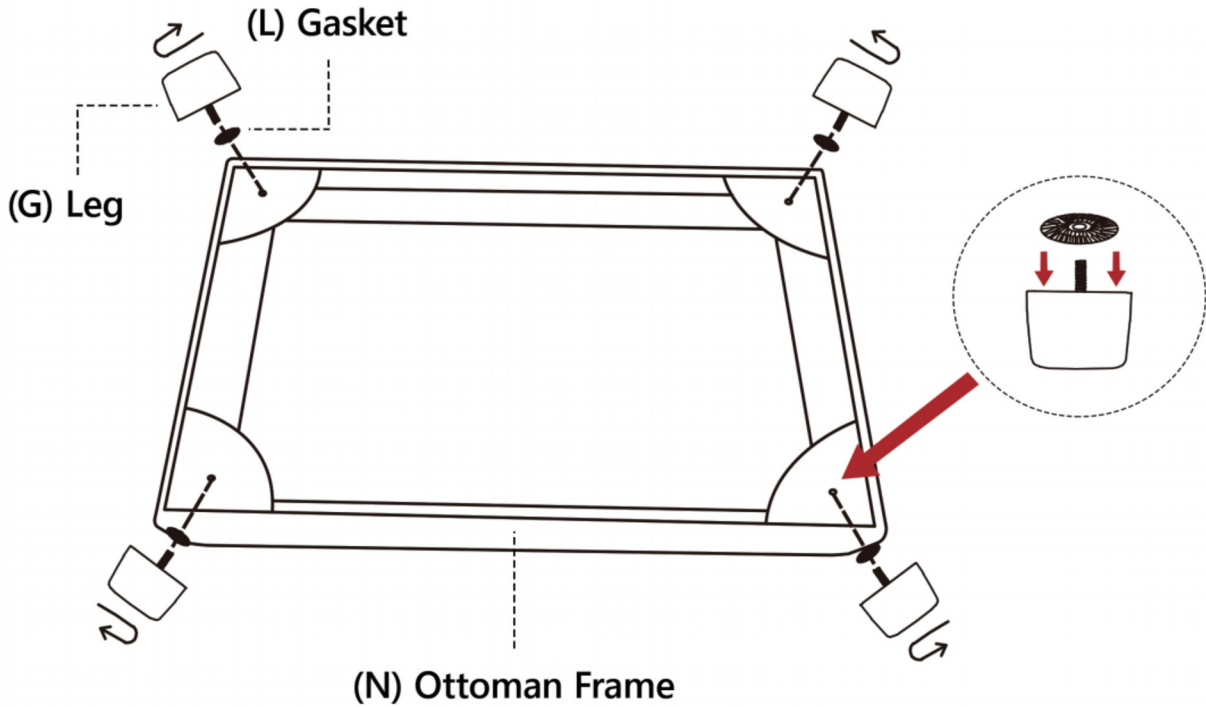

Step 2

The cushion is packaged by vacuum compression. After cutting the package, it rebounds quickly with in 4 hours. If the fabric has wrinkles, it will basically disappear after standing for 72 hours .

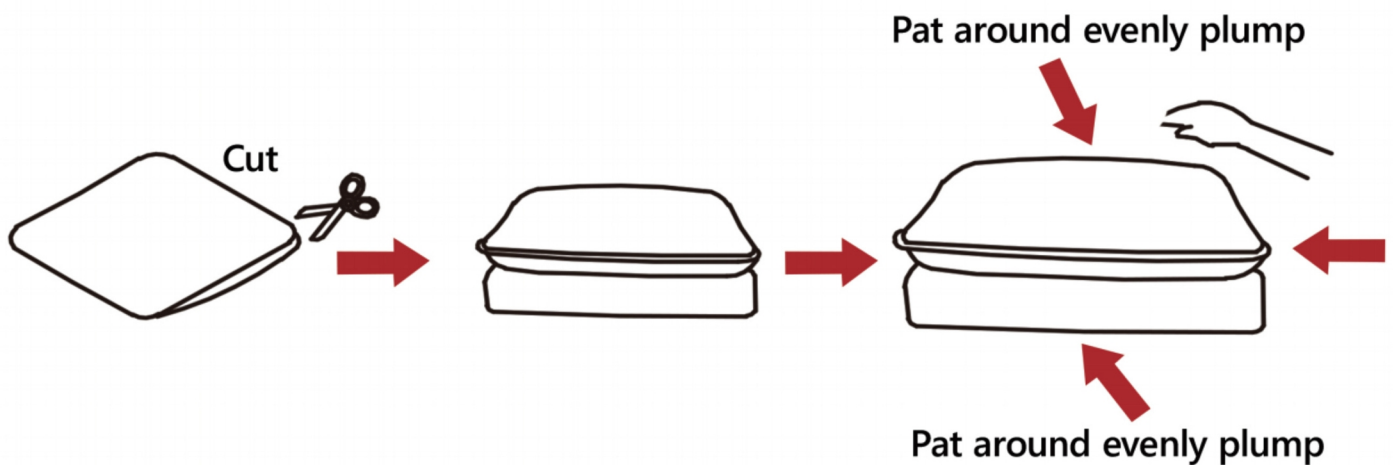

Step 3

Place seat ottoman cushion (O) on the ottoman frame (N).

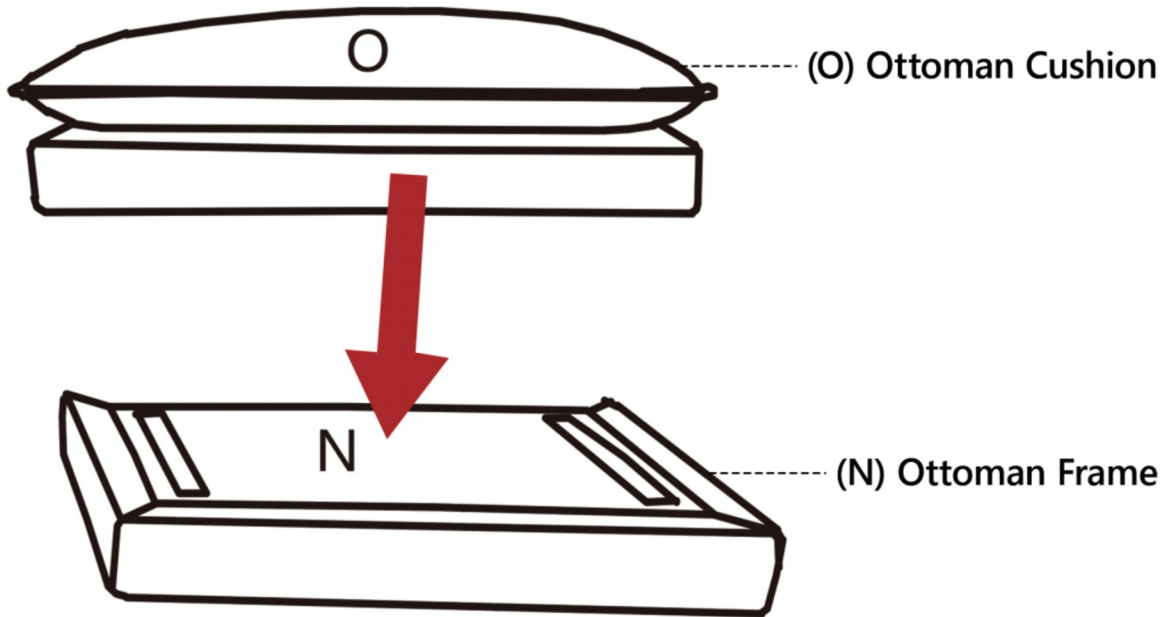

Step 4

If the fabric has wrinkles, it will basically disappear after standing for 72 hours.

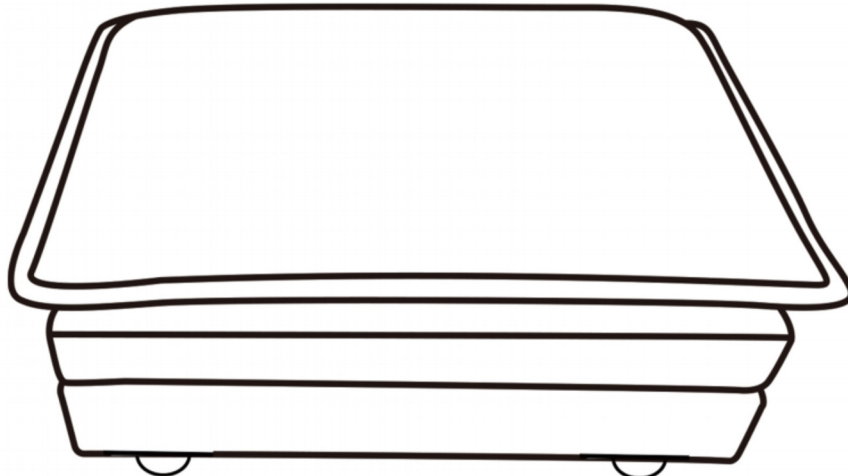

ASSEMBLY INSTRUCTION (CHAIR)



- Please install the 1- Seat / 2 - Seat / 3 - Seat Sofa according to the combination style you purchased.
- All single sofas are installed in the same way, you can add or subtract accessories and steps according to your purchase.
- Below you will find the installation accessories and steps for the 3 - Seat Sofa.

CHAIR COMPONENTS

► Parts List (BOX A)

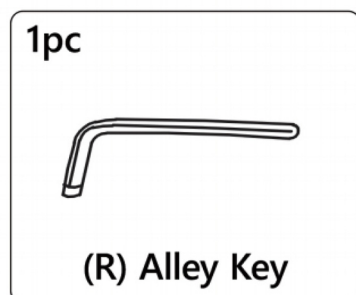
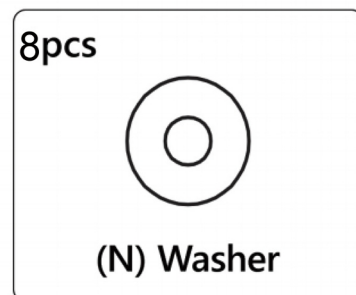
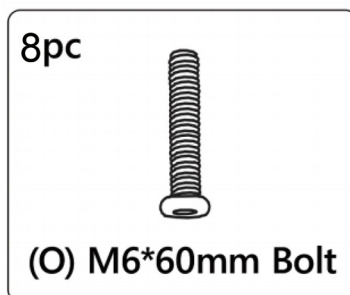
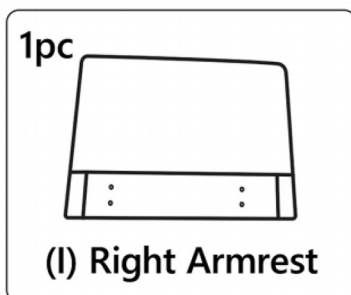
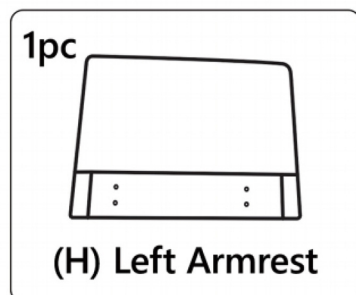

Note: Please retain all boxes until you are certain that your product isn't damaged and that you do not wish to return it. Disposal of boxes may prevent our ability to resolve your request.

CHAIR COMPONENTS

► Parts List (BOX B)

1pc

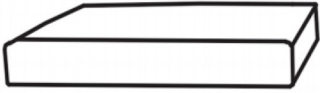

(A) Seat Frame

1pc

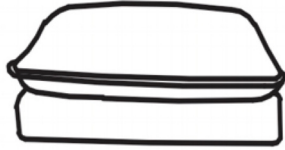

(B) Seat Cushion

1pc

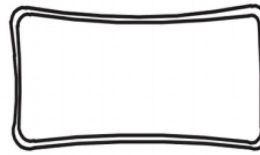

(C) Back Cushion

1pc

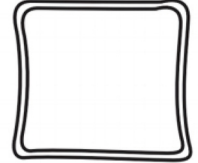

(E) Pillow

1pc

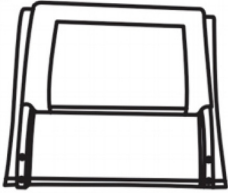

(F) Backrest

4pc



(G) Leg

4pcs+1pc



(L) Gasket

12pcs+1pc



(N) Washer

4pcs+1pc



(O) M6*60mm Bolt

4pcs



(P) M8*80mm Bolt

4pcs

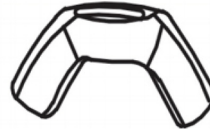

(Q) Butterfly Nut

1pc

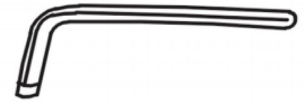

(R) Alley Key

Note: Please retain all boxes until you are certain that your product isn't damaged and that you do not wish to return it. Disposal of boxes may prevent our ability to resolve your request.

CHAIR COMPONENTS

► Parts List (BOX C)

2pcs

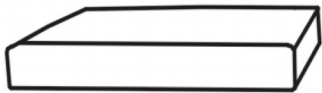

(A) Seat Frame

2pcs

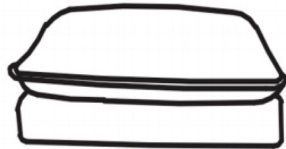

(B) Seat Cushion

2pcs



(C) Back Cushion

2pcs

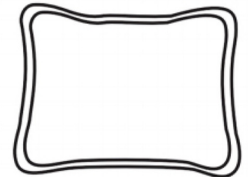

(D) Arm Pillow

2pcs

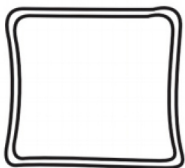

(E) Pillow

2pcs

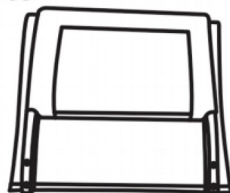

(F) Backrest

8pcs



(G) Leg

8pcs+2pc



(L) Gasket

24pcs+2pc



(N) Washer

8pcs+2pc



(O) M6*60mm Bolt

8pcs



(P) M8*80mm Bolt

8pcs



(Q) Butterfly Nut

2pcs



(R) Alley Key

Note: Please retain all boxes until you are certain that your product isn't damaged and that you do not wish to return it. Disposal of boxes may prevent our ability to resolve your request.

ASSEMBLY INSTRUCTION (CHAIR)

Step 1

Assemble Seat frame (A) and Seat frame (A) with Butterfly nuts (Q) Washers (N) and Bolts (P).

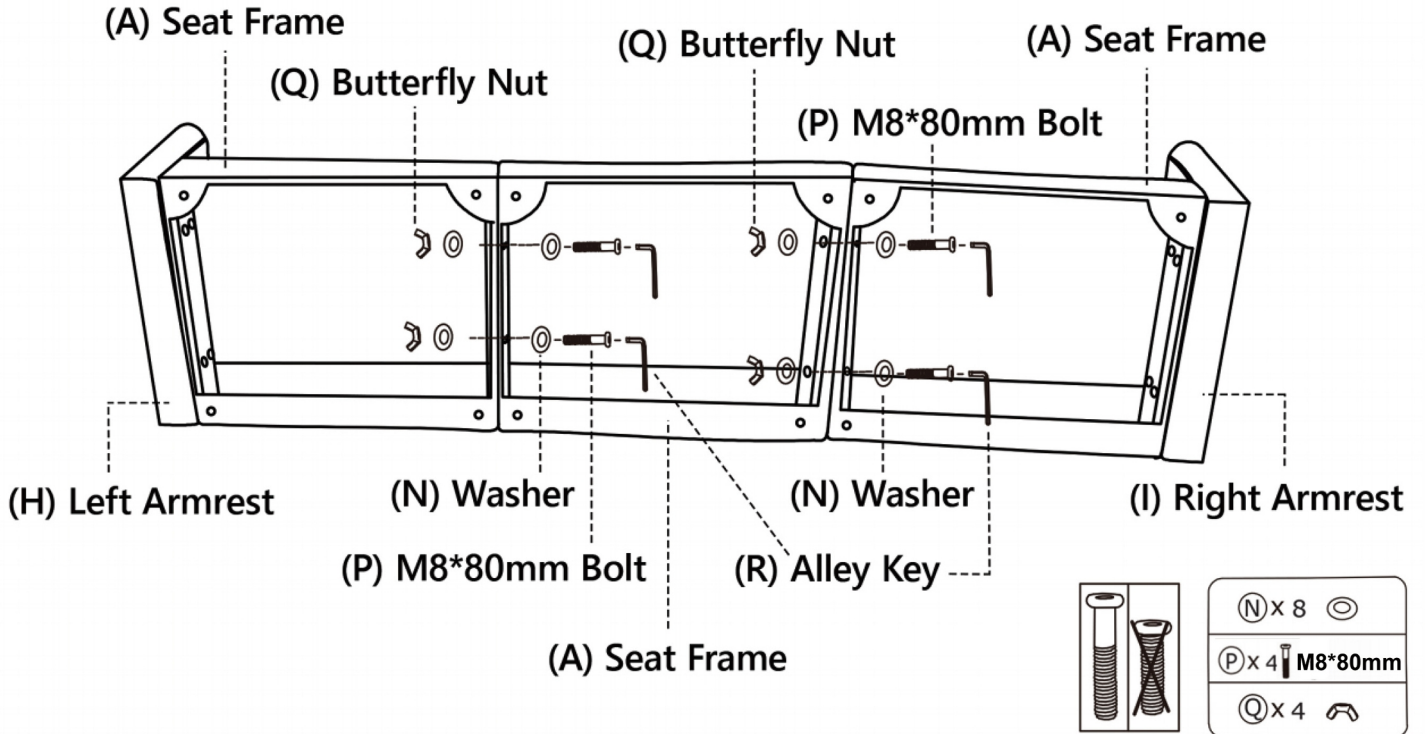

Step 2

Assemble the Legs (G) on the sofa with Gaskets (L).

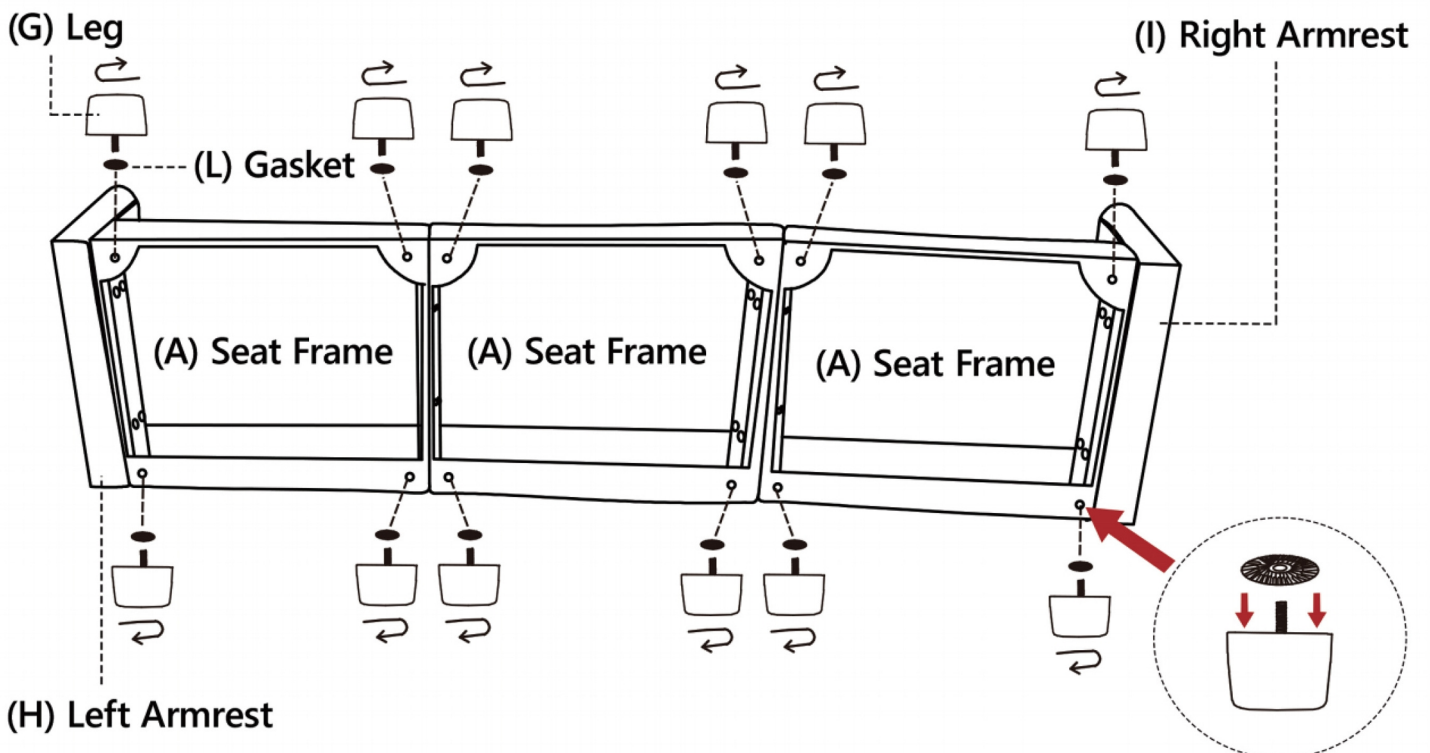

Step 3

Insert the Backrest (F) into the designated holes, using Washer (N) and Bolts (O) to 70% tightness, and then tighten the all Bolts on the seat.

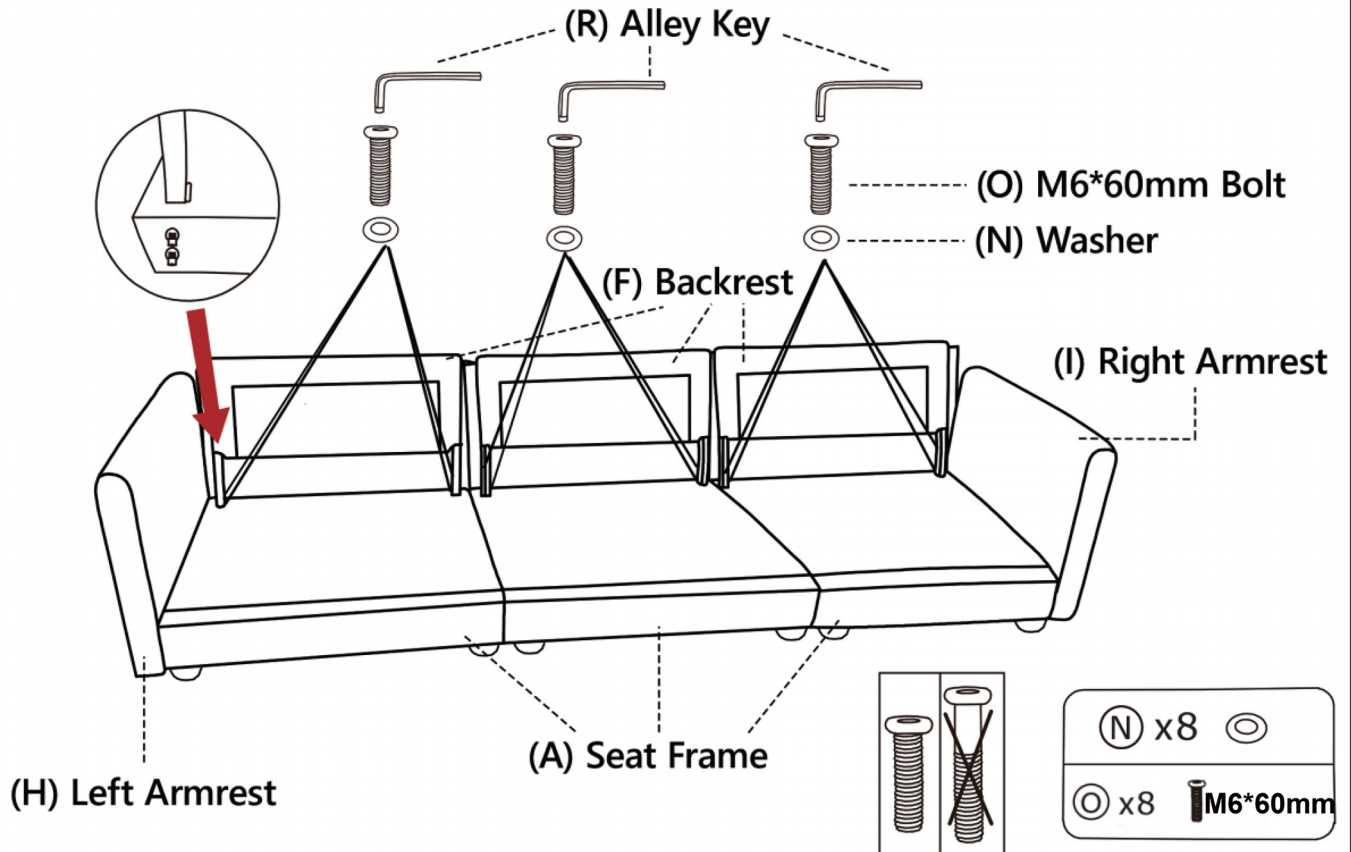

Step 4

The cushion is packaged by vacuum compression. After cutting the package, it rebounds quickly within 4 hours. If the fabric has wrinkles, it will basically disappear after standing for 72 hours.

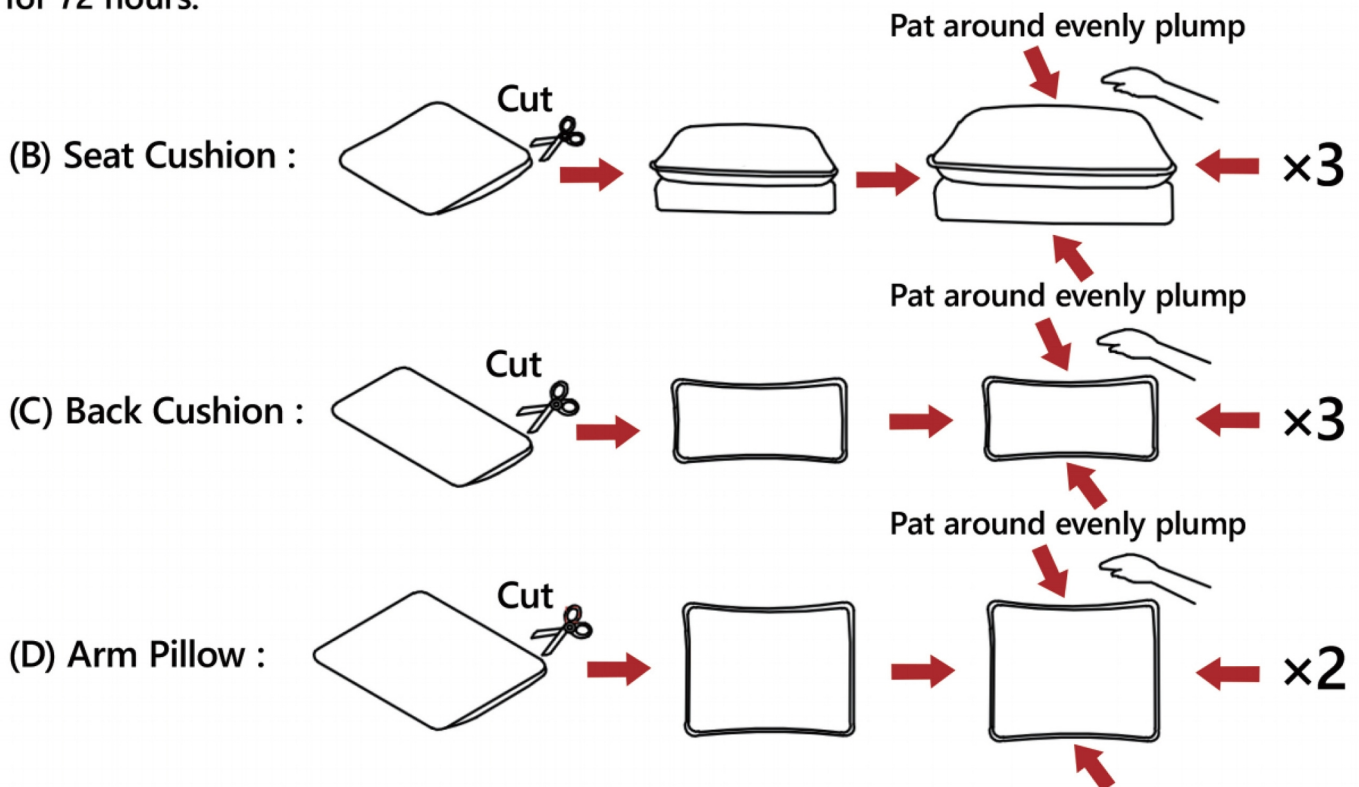

Step 5

Place Seat cushions (B) and back cushions (C), and make sure it's will fitted.

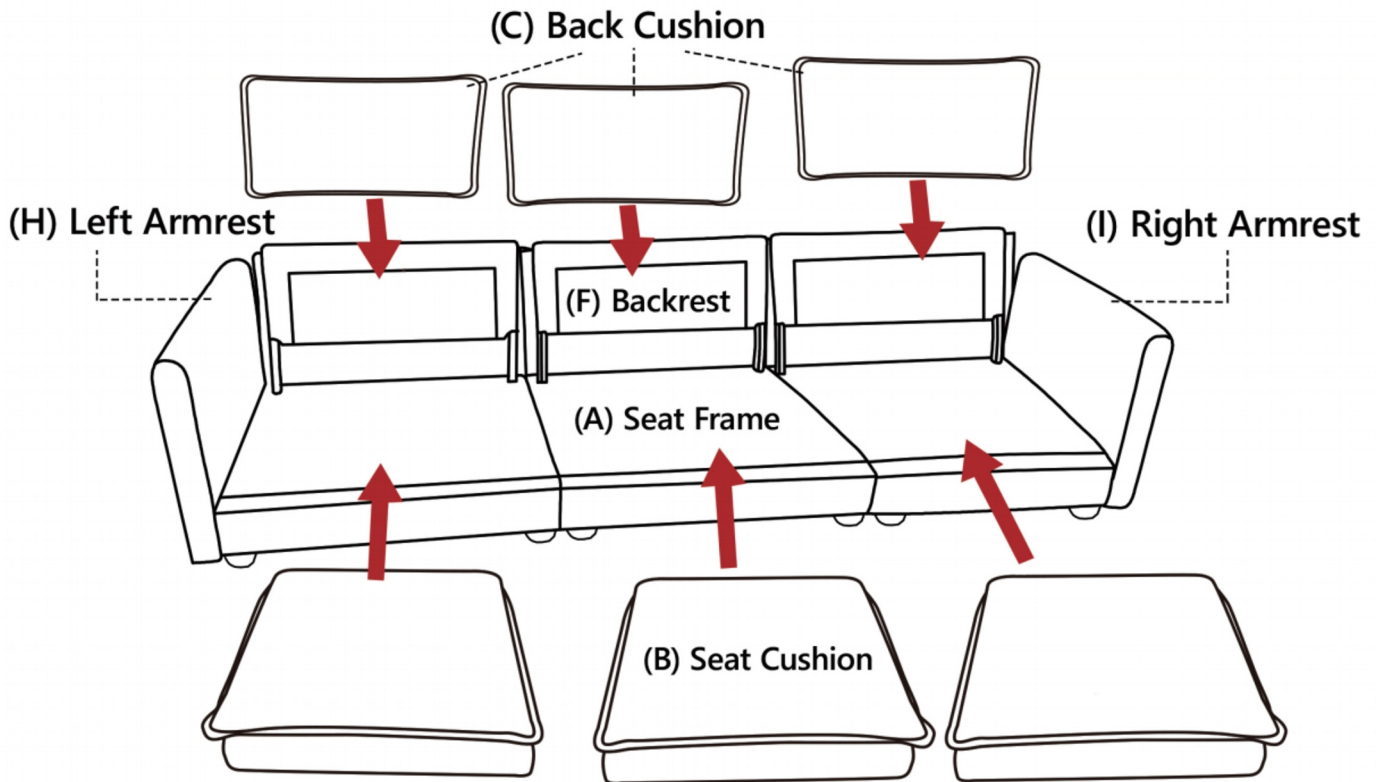

Step 6

Place Pillows (E) and Pillows (D) on sofa and make sure it's will fitted.

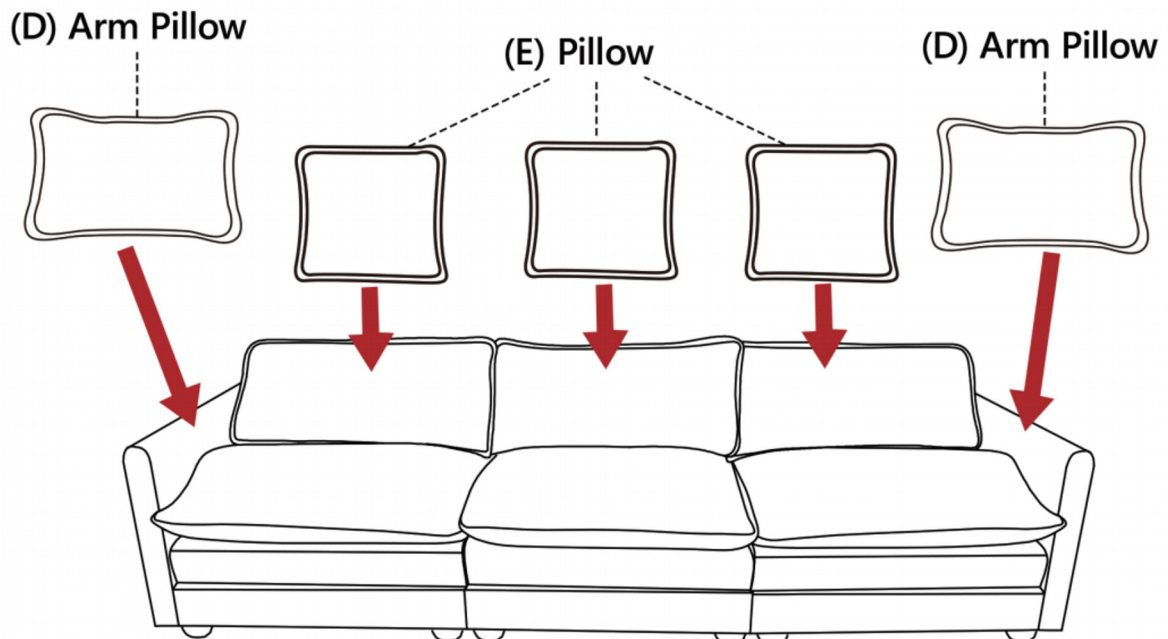

Step 7

If the fabric has wrinkles, it will basically disappear after standing for 72 hours. Well done!! You can enjoy your leisure time on the sofa now.

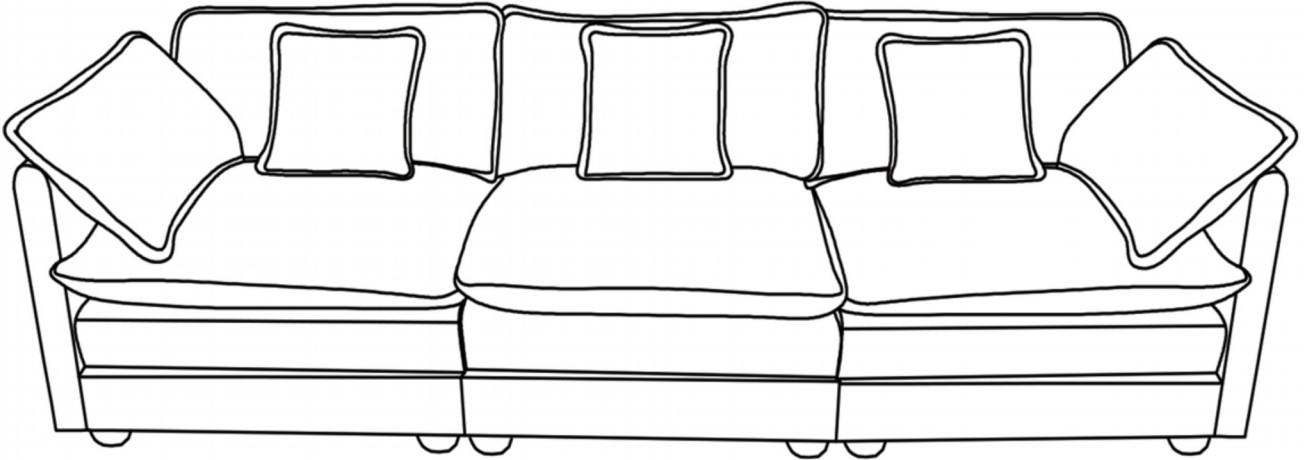

RETURN POLICY

- We hope you enjoy your new furniture as much as we enjoyed making it, if you have any comments or suggestion about our product, please feel free to share with us.
- We do our best to ensure your furniture arrives without any problems, but occasionally mistakes happen-as humans we are imperfect beings. In the event that a part is damaged or missing, we really don't want you to go through the hassle of re-packaging your item and sending it back, we will be more than happy to provide you with replacement part(s) for free. All your concerns will be taken good care of by Our CUSTOMER SERVICE TEAM.
- All returns must be shipped back in original boxes Pictures may be required for some returns to ensure an item is not damaged prior to its return. Items received without original boxes may not be accepted or may increase your return processing time.

! WARNING

Manufacturer and seller expressly disclaim any and all liability for personal injury, property damage or loss, whether direct, indirect, or incidental, resulting from the incorrect attachment, improper use, inadequate maintenance, unapproved modification, or neglect of this product.