

# ASSEMBLY INSTRUCTION

ITEM S5683/S5684/S5685/S5686/S5687

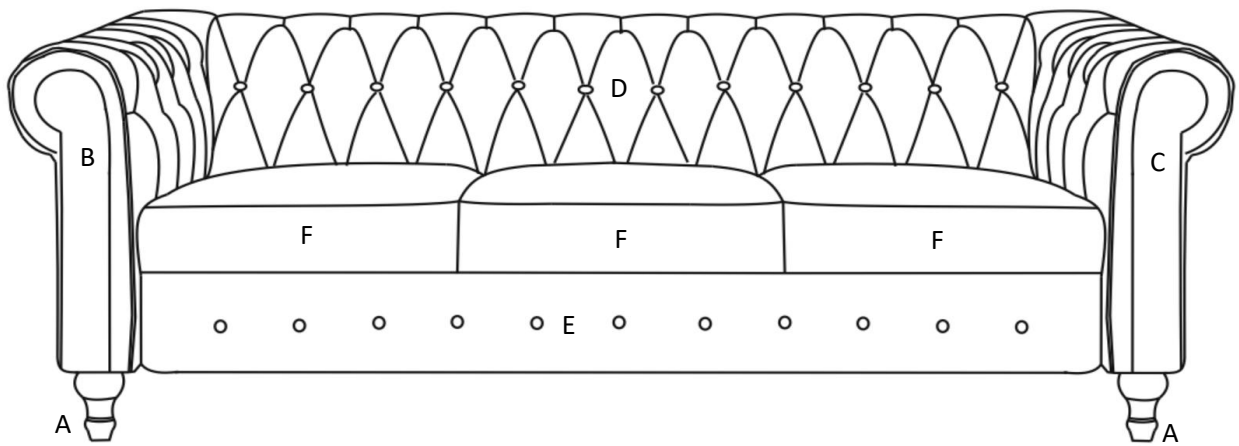

A: Legs 4PCS

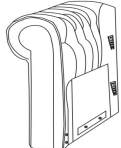

B: Left arm 1PC



C: Right arm 1PC

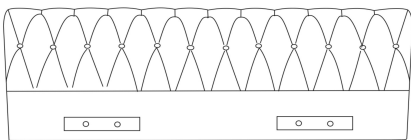

D: Back Rest 1PC



E: Front Board 1PC



F: Seat cushion 3PCS G: Base support 1PC H: Allen Key 1PC

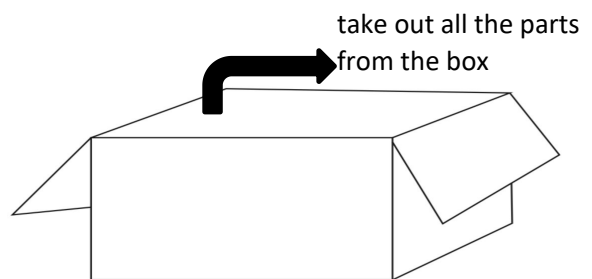

### STEP 1

Turn the legs A clockwise to fixed it on the both arm(B&C).

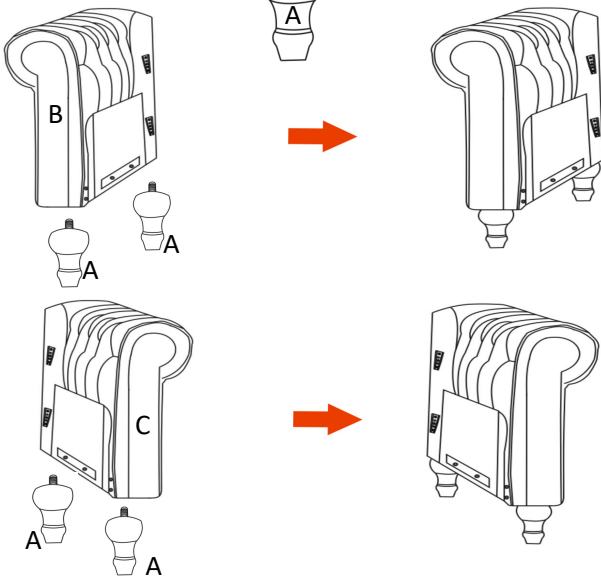

### STEP 2

Hook on the Back Rest (D) into Left Arm (B) and Right Arm (C) securely.

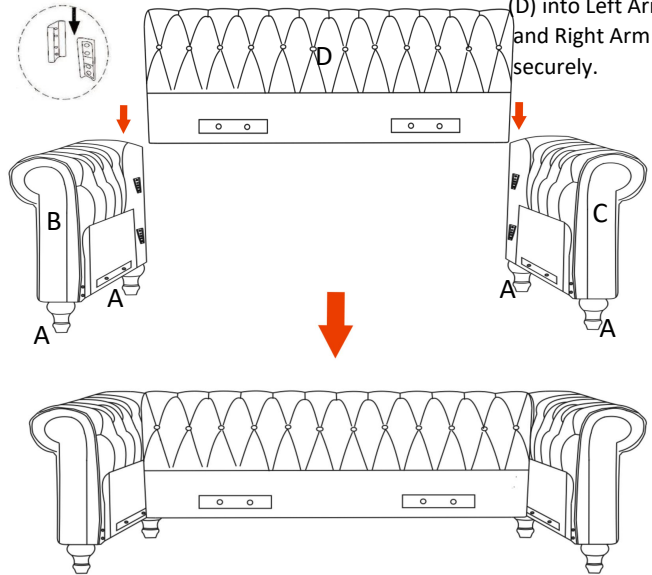

### STEP 3

Slightly loosen the four bolts using Allen Key(H) without removing the bolts completely from both Side Arms (B&C). Hook on Front Board (E) hooks into loosen bolts, once placed tighten and secure all four bolts with Allen Key (H)

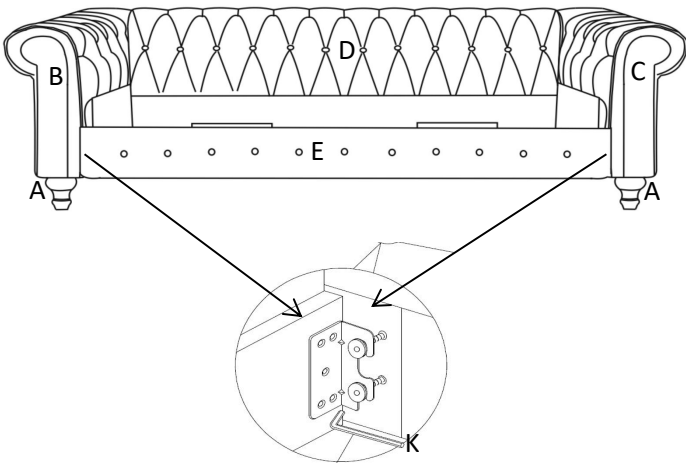

### STEP 4

① Put the Base support (G) into the sofa frame

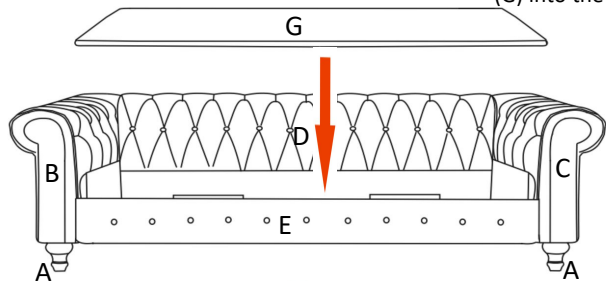

② Put the Seat cushion(F) on the Base Support(G)

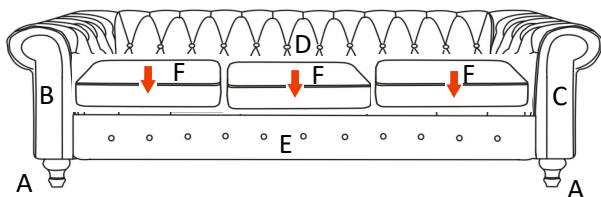

### STEP 5

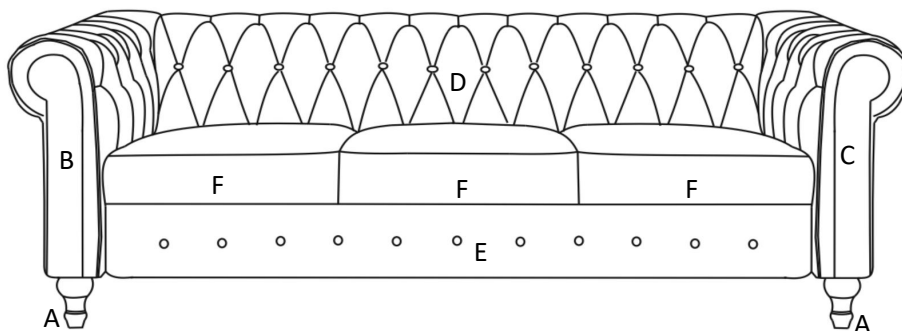

# ASSEMBLY INSTRUCTION

ITEM S5683/S5684/S5685/S5686/S5687

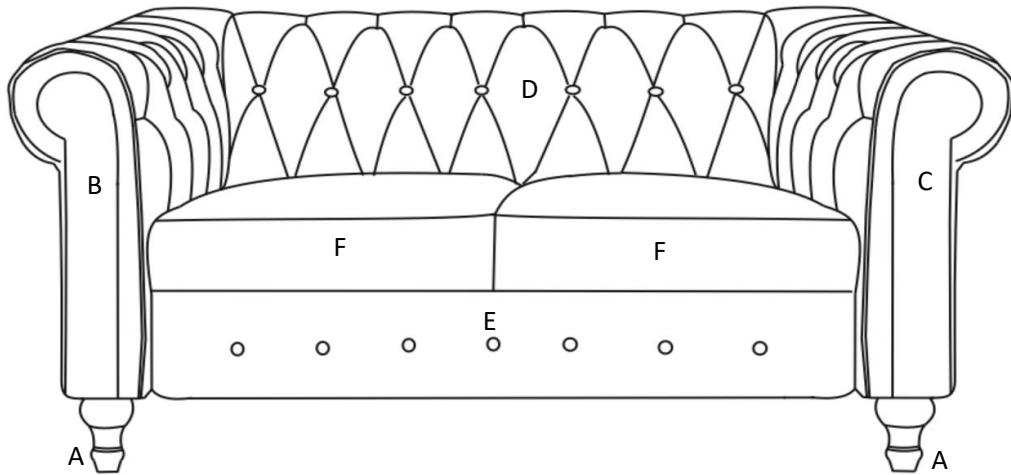

A:Legs 4PCS

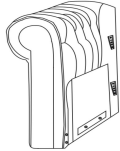

B:Left arm 1PC



C:Right arm 1PC

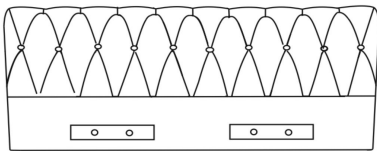

D:Back Rest 1PC

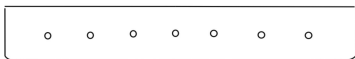

E:Front Board 1PC



F:Seat cushion 2PCS G: Base support 1PC H:Allen Key 1PC

take out all the parts  
from the box

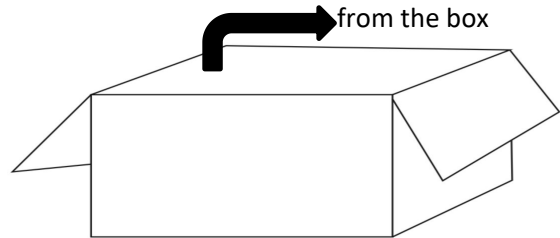

### STEP 1

Turn the legs A clockwise to fixed it on the both arm(B&C).

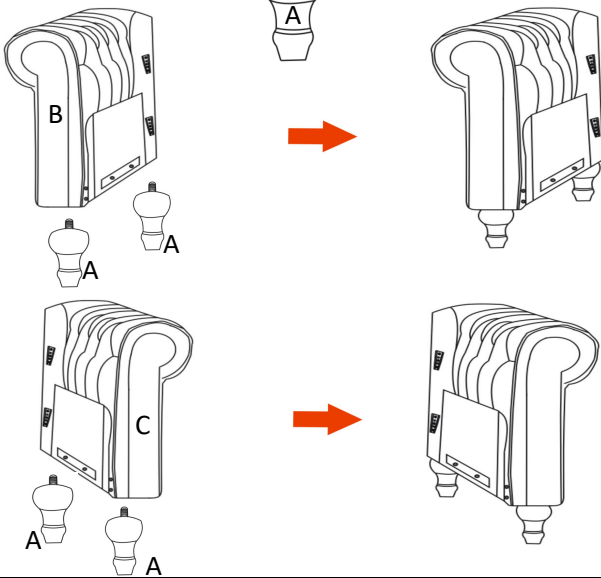

### STEP 2

Hook on the Back Rest (D) into Left Arm (B) and Right Arm (C) securely.

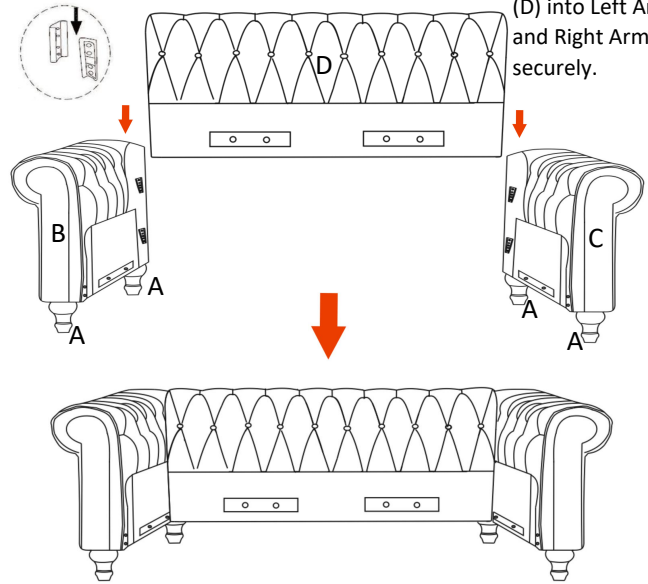

### STEP 3

Slightly loosen the four bolts using Allen Key(H) without removing the bolts completely from both Side Arms (B&C). Hook on Front Board (E) hooks into loosen bolts, once placed tighten and secure all four bolts with Allen Key (H)

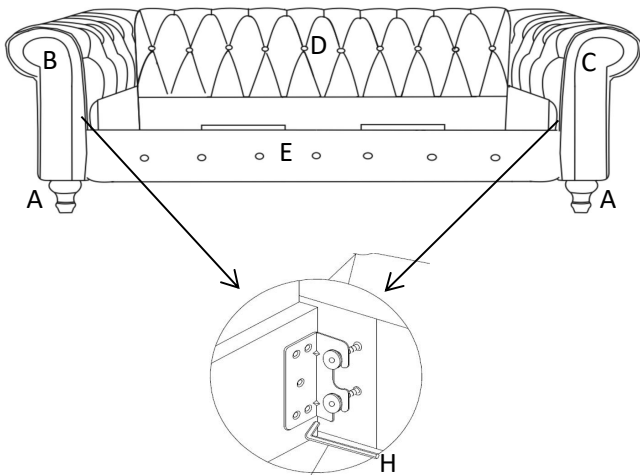

### STEP 4

① Put the Base support (G) into the sofa frame

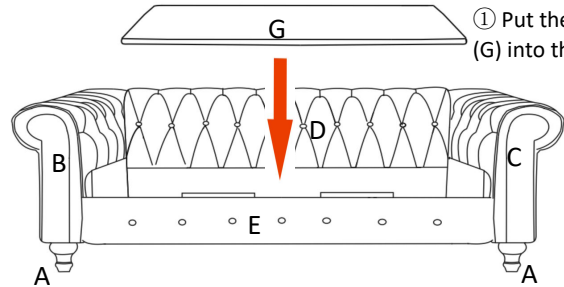

② Put the Seat cushion(F) on the Base Support(G)

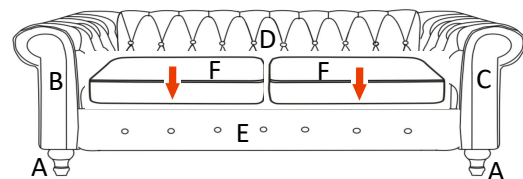

### STEP 5

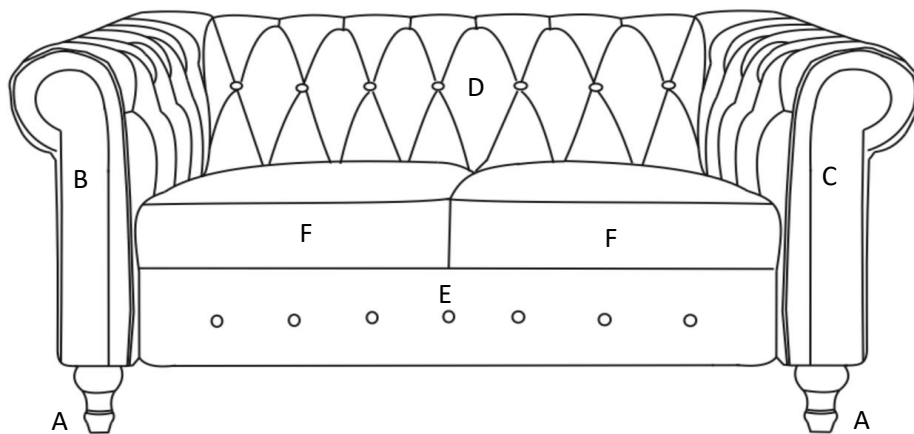

# ASSEMBLY INSTRUCTION

ITEM S5683/S5684/S5685/S5686/S5687

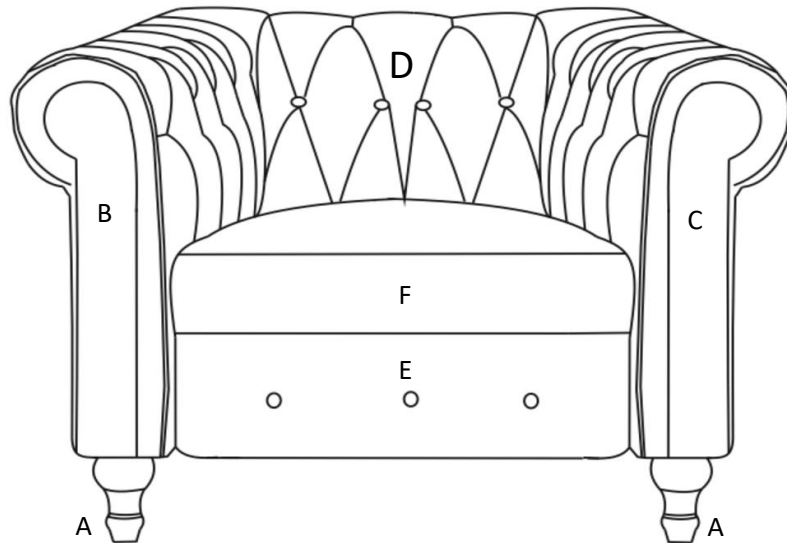

A:Legs 4PCS



B:Left arm 1PC



C:Right arm 1PC

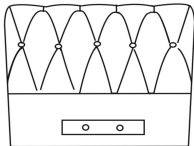

D:Back Rest 1PC



E:Front Board 1PC

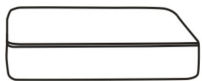

F:Seat cushion 1PC



G: Base support 1PC



H:Allen Key 1PC

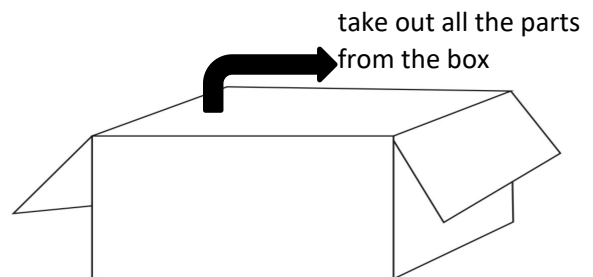

### STEP 1

Turn the legs (A) clockwise to fixed it on the both arm(B&C).

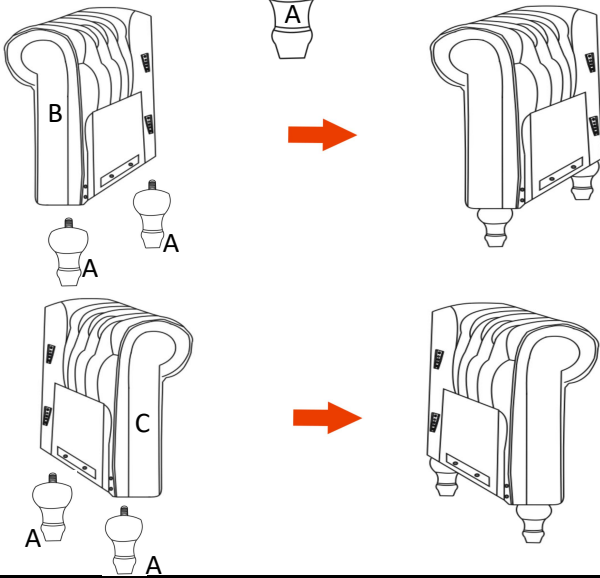

### STEP 2

Hook on the Back Rest (D) into Left Arm (B) and Right Arm (C) securely.

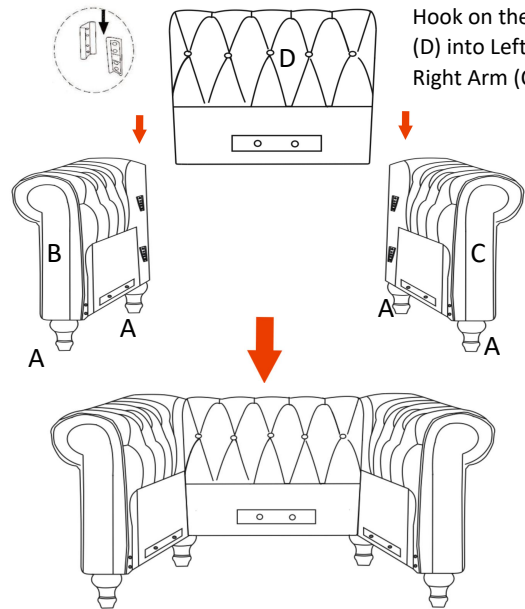

### STEP 3

Slightly loosen the four bolts using Allen Key(H) without removing the bolts completely from both Side Arms (B&C). Hook on Front Board (E) hooks into loosen bolts, once placed tighten and secure all four bolts with Allen Key (H)

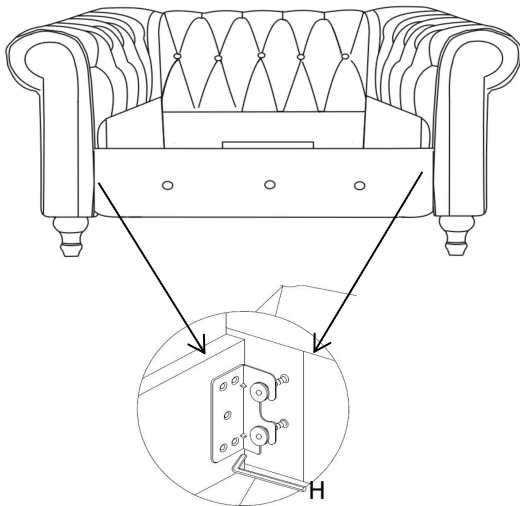

### STEP 4

① Put the Base support(G) into the sofa frame

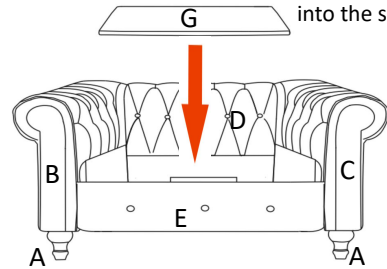

② Put the Seat cushion(F) on the Base Support(G)

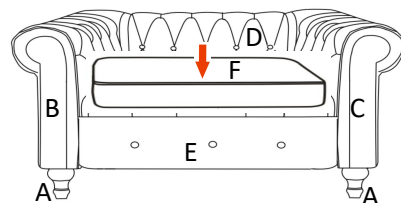

### STEP 5

