



USER'S MANUAL









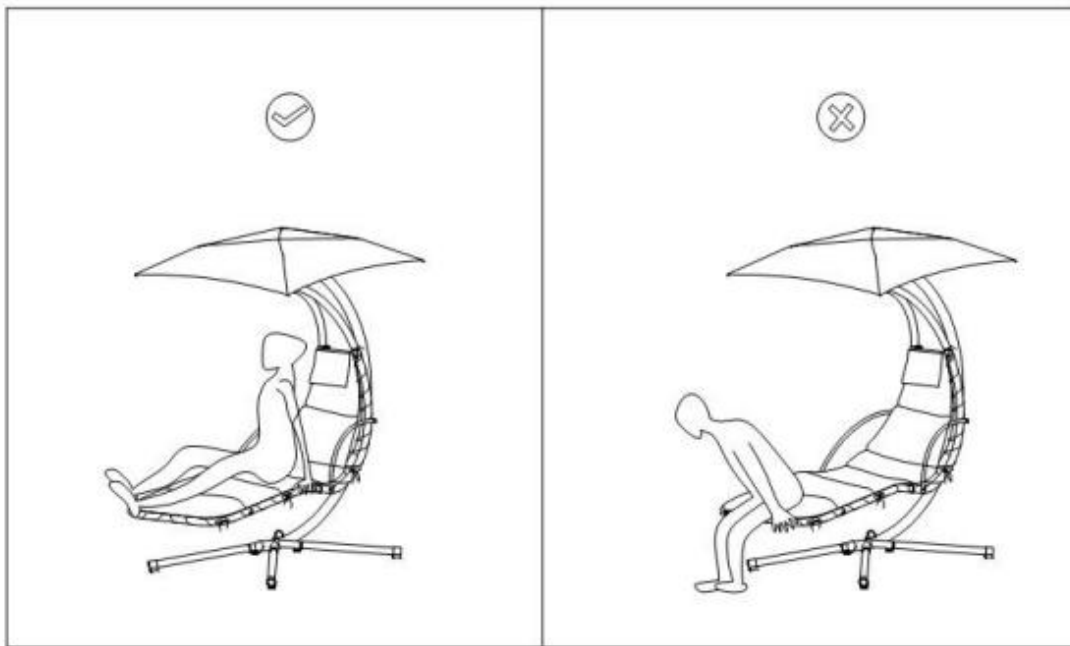





Hanging Chaise Lounger Patio Hammock Swing













THIS INSTRUCTION BOOKLET CONTAINS IMPORTANT SAFETY INFORMATION. PLEASE READ AND KEEP FOR FUTURE REFERENCE.

Before You Start

- ⚠ Please read all instructions carefully.
- ⚠ Retain instructions for future reference.
- ⚠ Separate and count all parts and hardware.
- ⚠ Read through each step carefully and follow the proper order.
- ⚠ We recommend that, where possible, all items are assembled near to the area in which they will be placed in use, to avoid moving the product unnecessarily once assembled.
- ⚠ Always place the product on a flat, steady and stable surface.
- ⚠ Keep all small parts and packaging materials for this product away from babies and children as they potentially pose a serious choking hazard.



 A*1pc	 E*1pc	 I*1pc	 M*1pc
 B*1pc	 F*1pc	 J*1pc	 N*1pc
 C*4pcs	 G*1pc	 K*1pc	
 D*2pcs	 H*2pcs	 L*1pc	

M8×25  1*4pcs	M10  6*1pc	13-17  1pc
∅60  2*2pcs	M8×20  7*2pcs	14-17  1pc
∅42  3*2pcs	M8×65  8*4pcs	N5  1pc
∅8  4*1pc	M8×70  9*1pc	
∅8  5*1pc	M10×95  10*1pc	

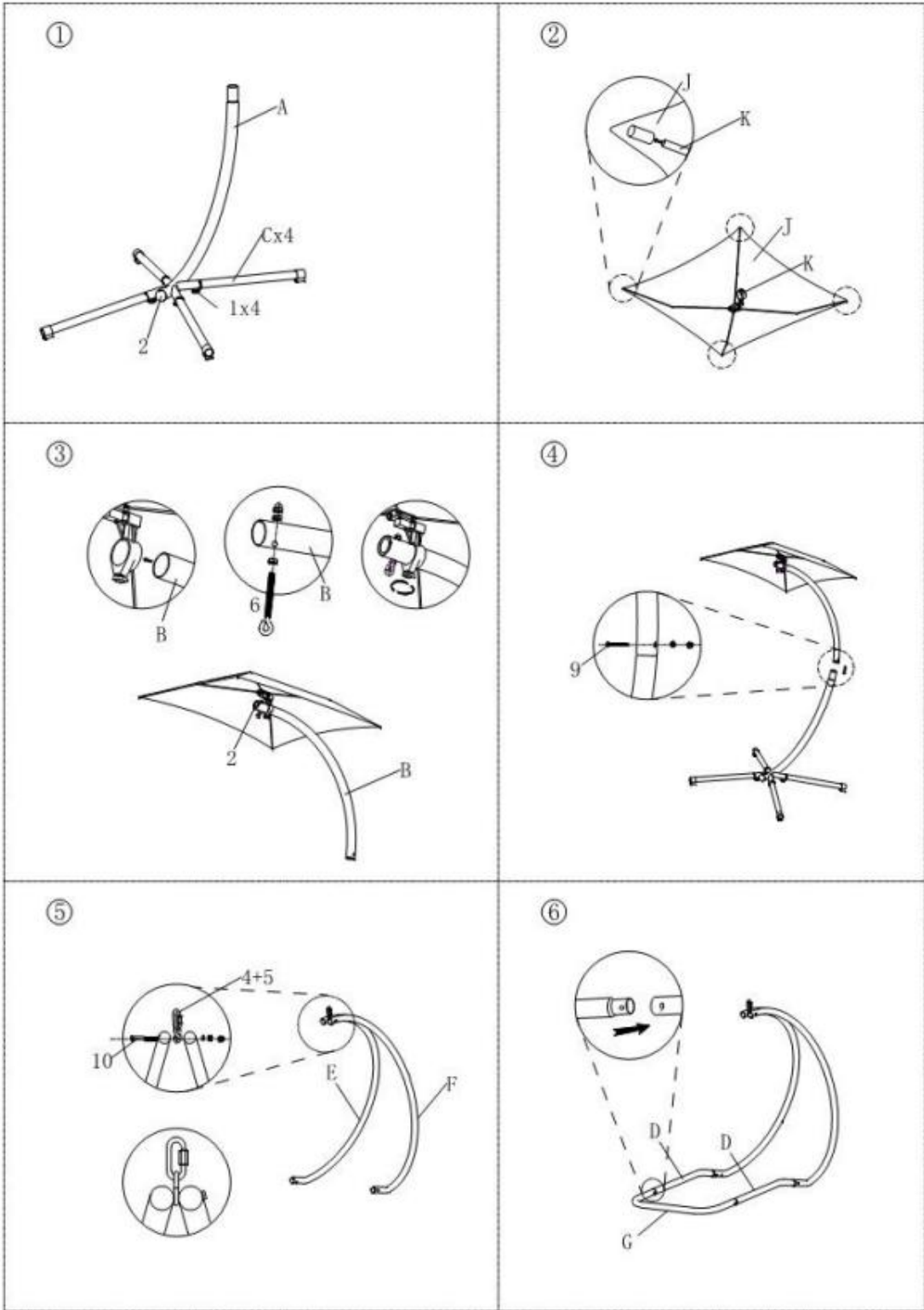

⑦

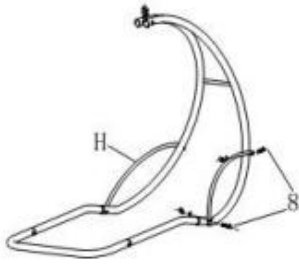

⑧

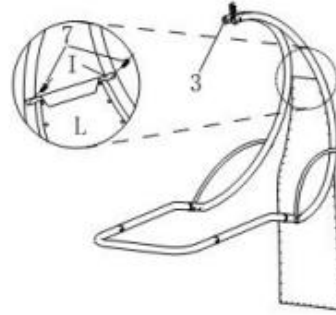

⑨

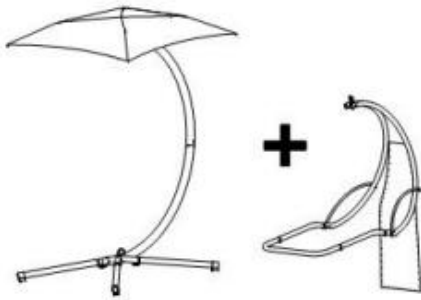

⑩



⑪

