

# INSTALLATION

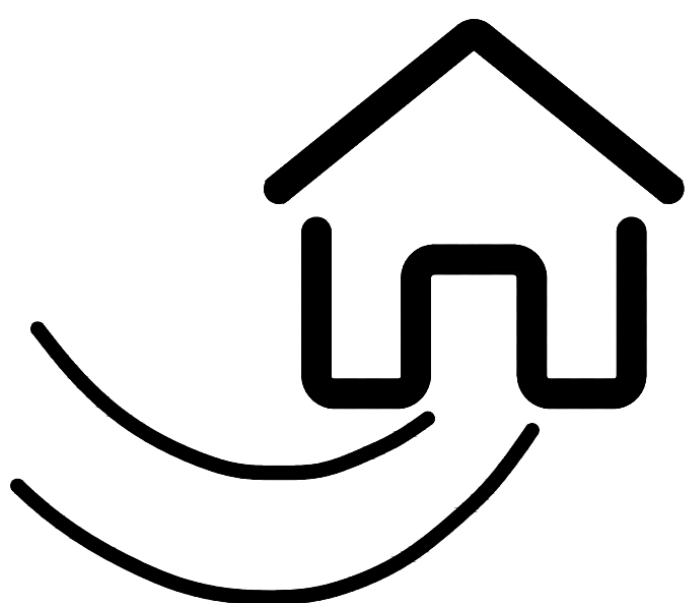

**CAUTION**

Part are placed at the bottom of the product.

# Assembly Instructions

Your recliner comes packaged in one box. Carefully remove all of components from the packaging and set aside for assembly.

**CAUTION:**

**DO NOT** use any sharp objects to open plastic wrapped components as damage to product or components may result.

## Package Contents

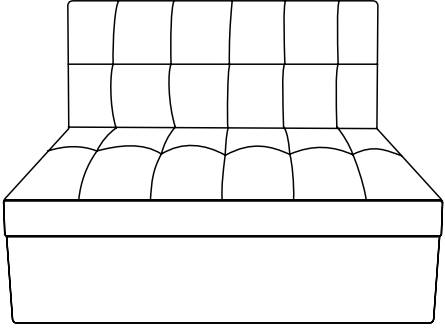
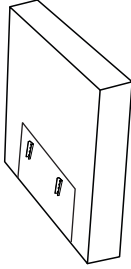
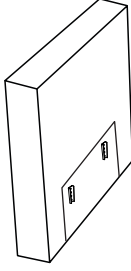
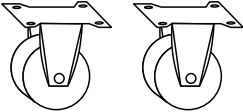
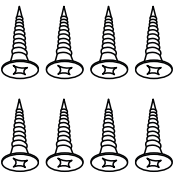
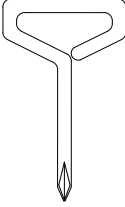
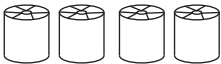
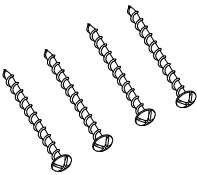
 <p>Seat Frame</p>	 <p>Right side frame</p>	 <p>Left side frame</p>
<p><b>A x 1</b></p>	<p><b>B x 1</b></p>	<p><b>C x 1</b></p>
 <p>Wheels</p>	 <p>Wheel Screw</p>	 <p>Allen Wrench</p>
<p><b>D x 2</b></p>	<p><b>E x 8</b></p>	<p><b>F x 1</b></p>
 <p>Leg</p>	 <p>Screw M8 x 45mm</p>	
<p><b>G x 4</b></p>	<p><b>H x 4</b></p>	

.....

**Step 1:** Assembly the Leg (G) to the Left and Right frame (B)and (C) using wood screw (H).

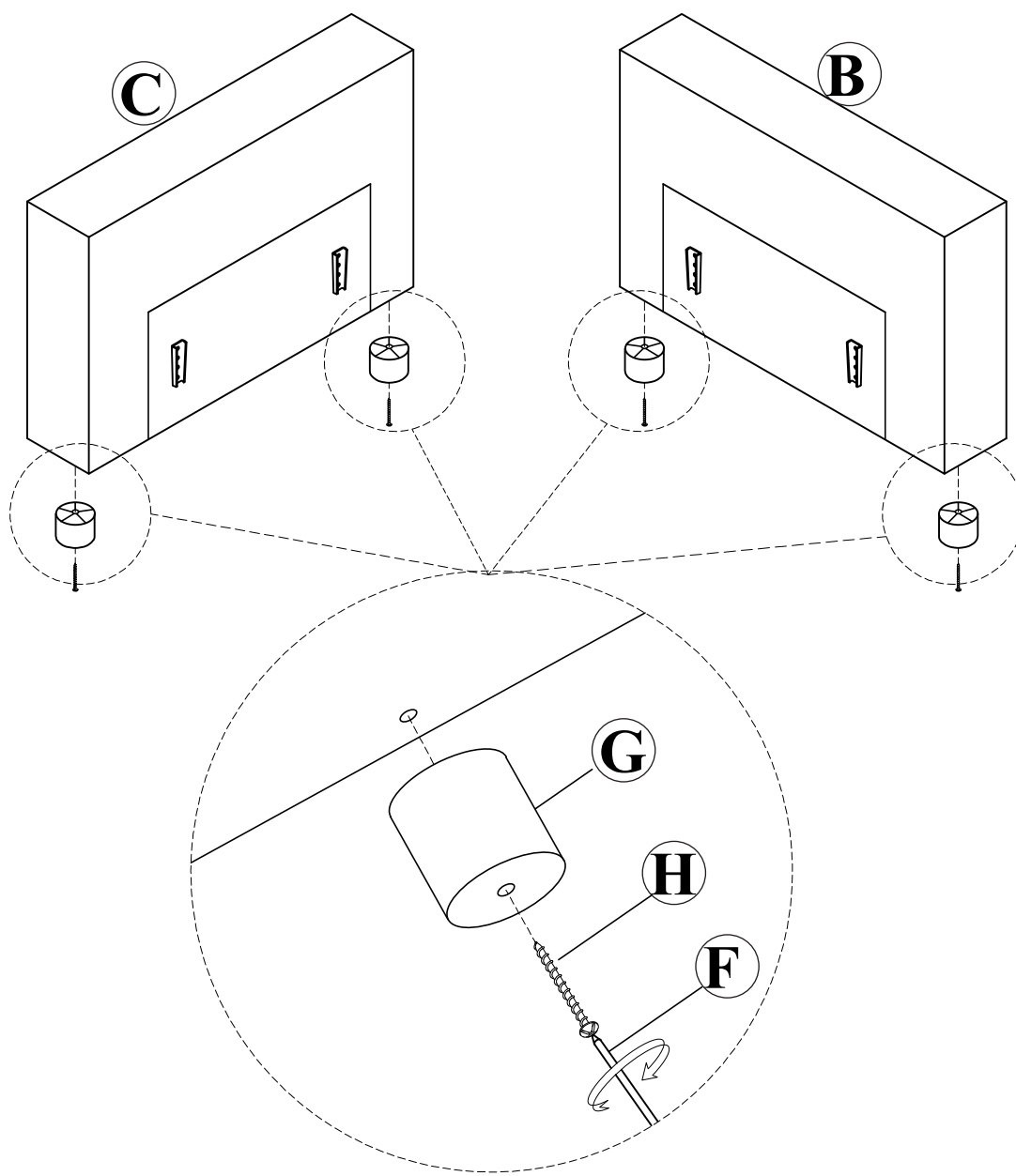

.....

**Step 2:** Assembly the Wheel (D) to the Seat Frame (A) using wood screw (E)

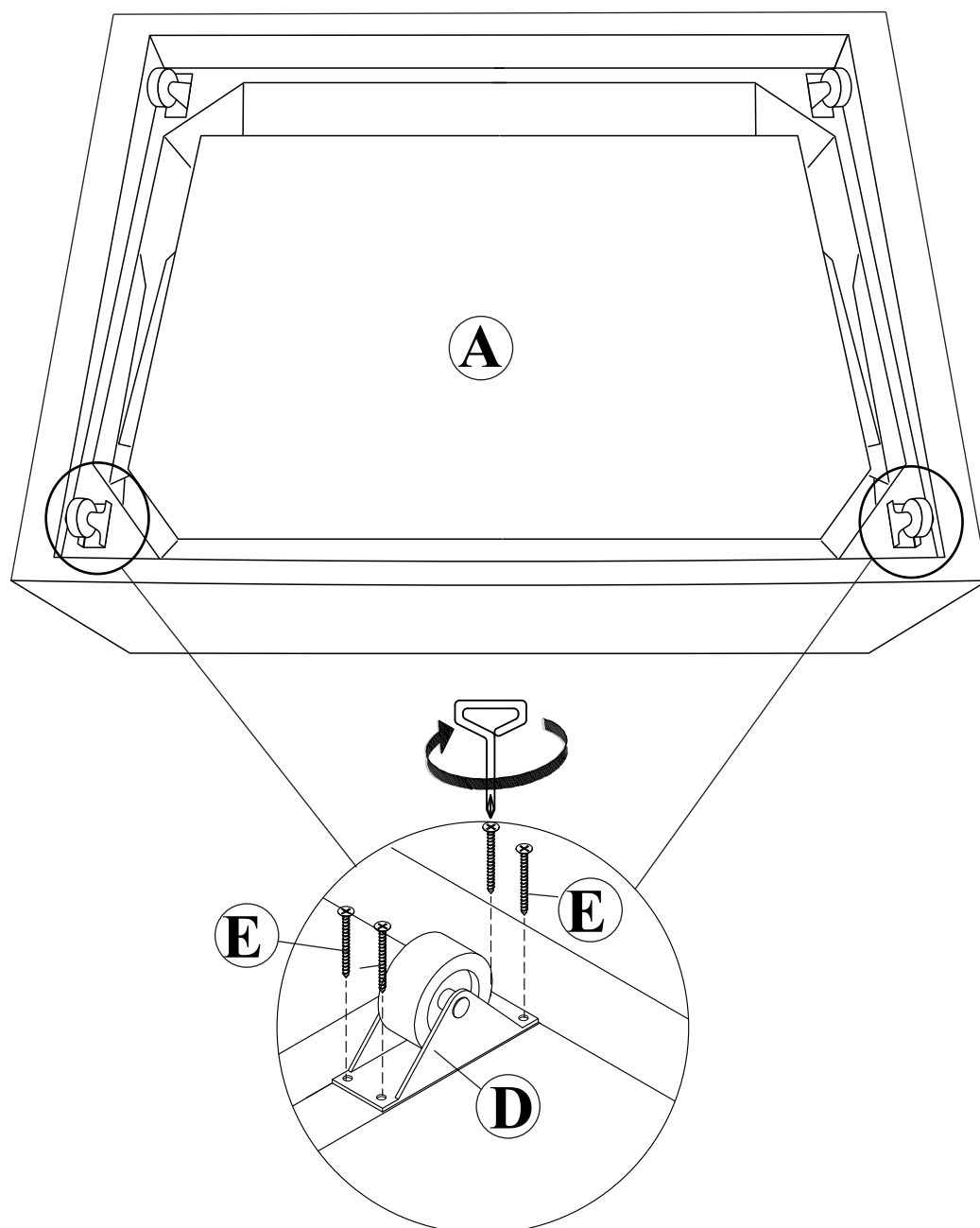

**Step 3:** Assembly the Left and Right side frame (B) &(C) to the Seat Frame (A).

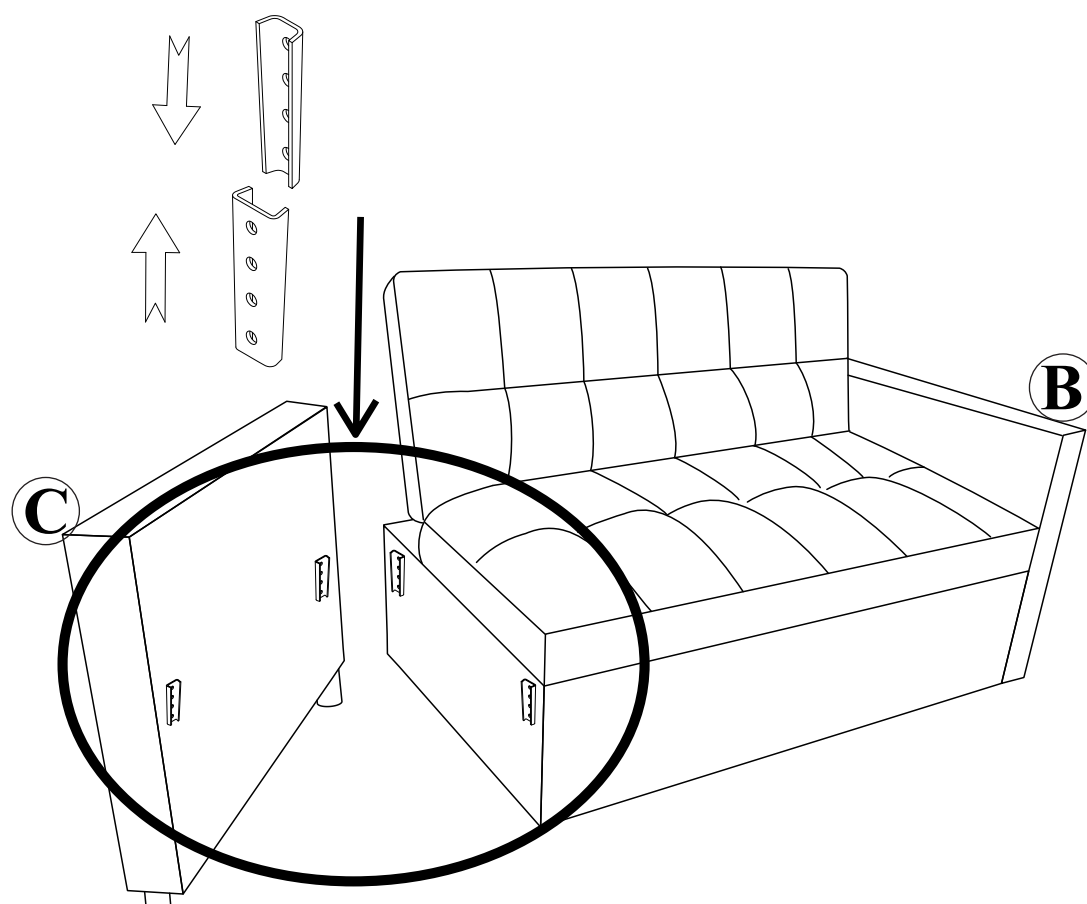



## Step 4:

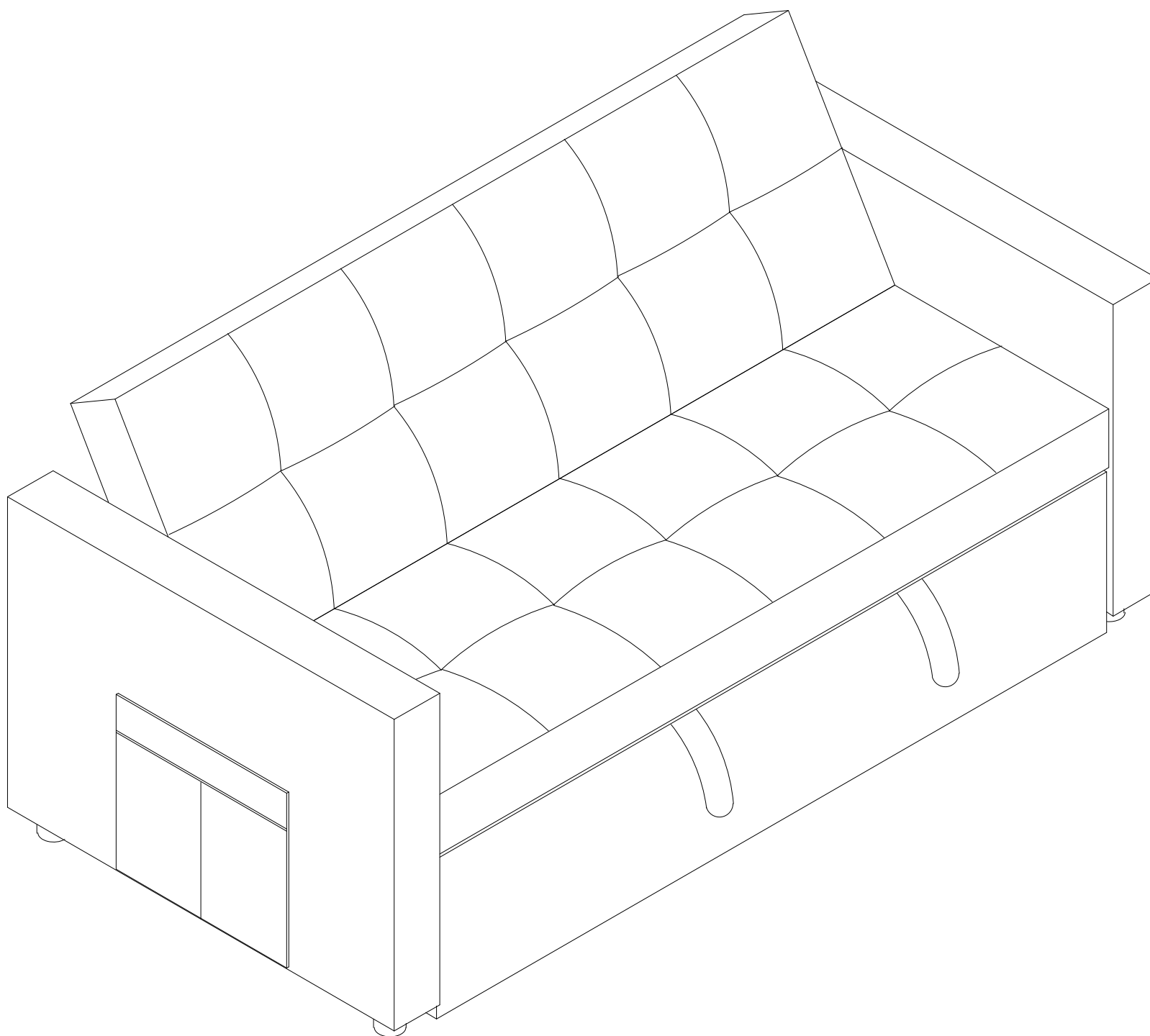

FUNCTIONS :

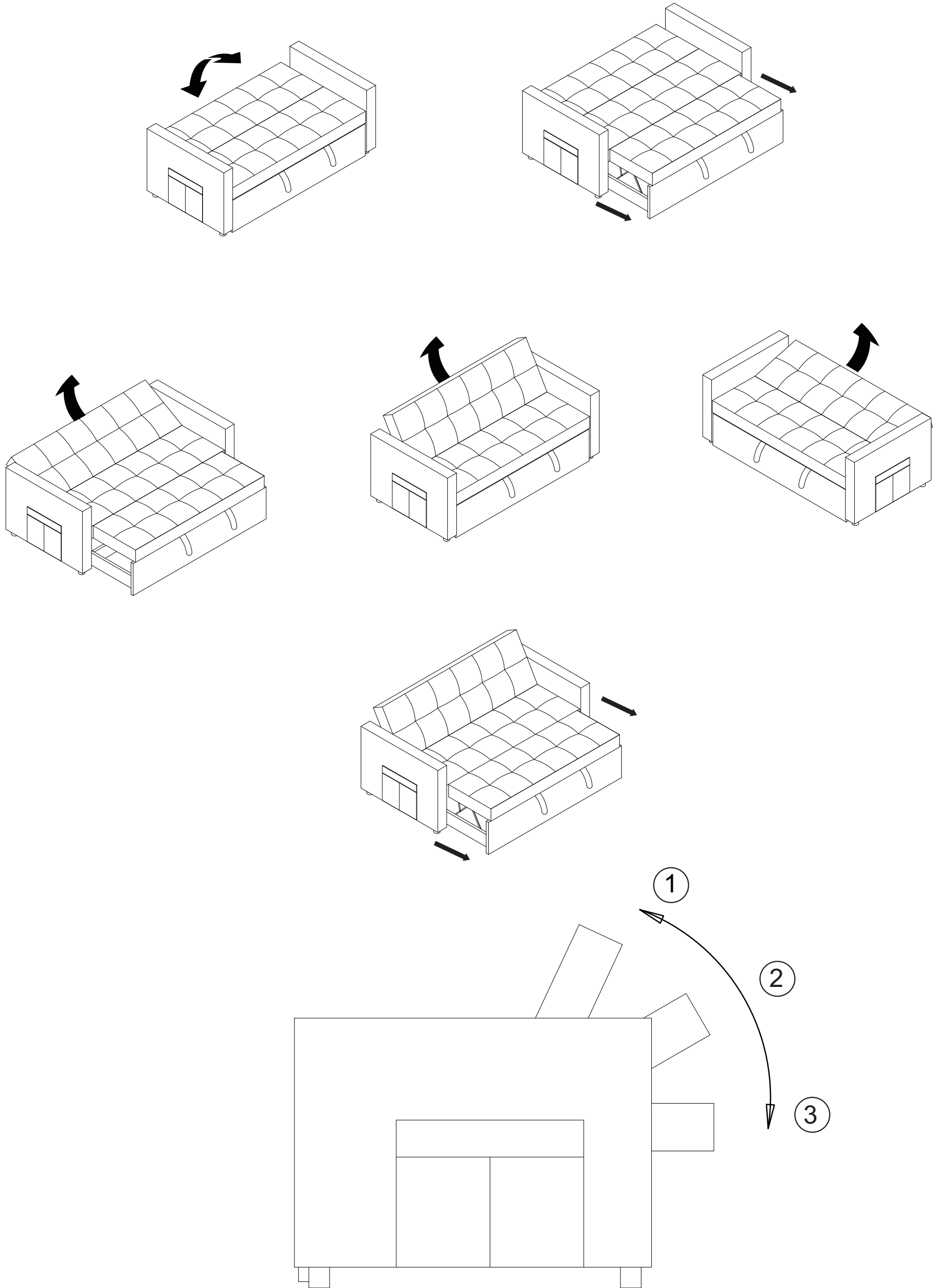

## Warnings

1. Please check if the components of the chair are all included and can be used normally.
2. Assemble all components according to the instruction correctly
3. Please DO NOT sit on the armrests or footrest to eliminate the risk of tipping over.
4. If the chair is damaged or doesn't match the website description, please send clear pictures of the product and label of the carton to our service team for further help.
5. If you have any questions with the product, please contact us

