

# OWNER MANUAL

---

## NOTE:

This brochure contains **IMPORTANT** safety info. Please read and keep for future reference.

---

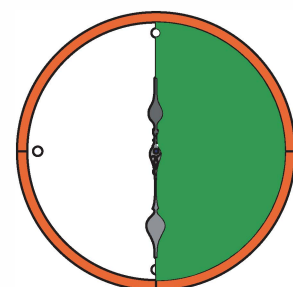

# MAINTENANCE AND WARNING

1. Keep furniture away from heat sources.
2. Do not clean furniture with harsh cleaner or polishes. Do not use detergents, solvents, abrasives, spray packs or leather cleaner. Use non-color mild soap with warm water to clean spills (Mix 1:10 soap to water).
3. Do not place furniture under direct sunlight, material will possibly fade over time.
4. Do not use on site dry cleaning machine. Children should not climb or jump on the furniture.
5. Do not write on furniture that is not protected by a padded barrier.
6. Not for commercial use, only for residential use.



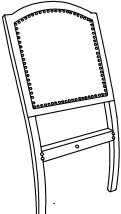
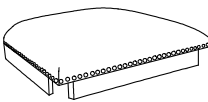

Around **30 min**

# PARTS LIST

A	x1	B	x1	C	x1
					

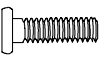

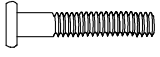
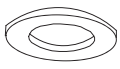
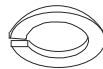
# HARDWARE LIST

#1	x1	#2	x4	#3	x4	#4	x9	#5	x9
									
M8x50mm		M8x60mm		M8x95mm		M8		M8	

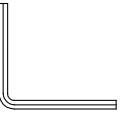
# TOOL LIST

#6	x1
	
M6	

# HARDWARE SPARE LIST

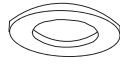
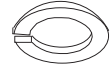



#2	x1	#3	x1	#4	x2	#5	x2
							
M8x60mm		M8x95mm		M8		M8	

# ASSEMBLY INSTRUCTIONS

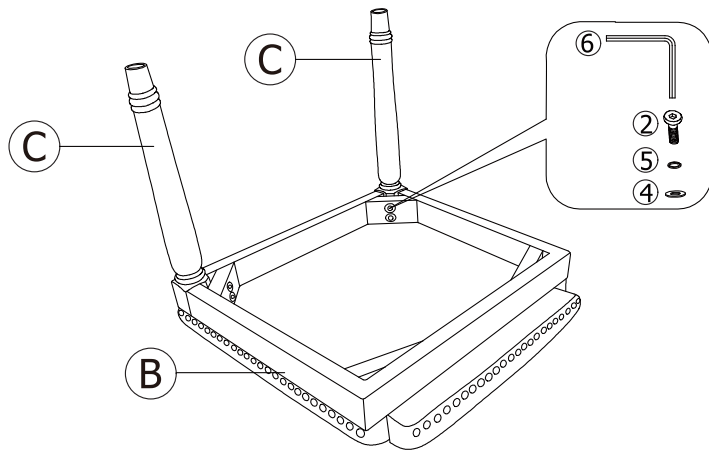
## STEP- 1

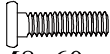
Attach the front legs on the wood base by put the screws in the holes.  
Tighten the screws to 50%





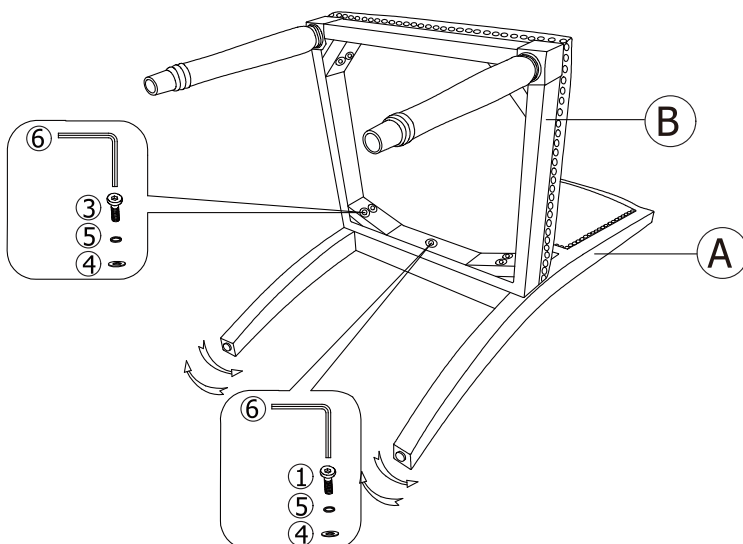

2	 M8x60mm	x4
4	 M8	x4
5	 M8	x4
6	 M6	x1

## STEP- 2

Attach the back legs on the wood base by put the screws in the holes.  
Tighten the screws to 50%



1	 M8x50mm	x1
3	 M8x60mm	x4
4	 M8	x5
5	 M8	x5
6	 M6	x1

# ASSEMBLY INSTRUCTIONS

## STEP- 3

Place the chair on a flat and evel surface, ensuring that all fourfeet touch the ground smoothly, and tighten (100%) all screws.

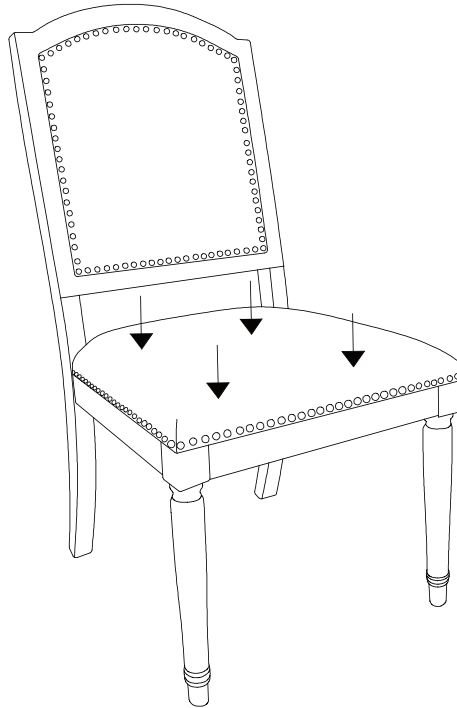

## STEP-4

Assembly completed.

If the chair is uneven,  
pleaseadjust the bottom  
nut appropriately

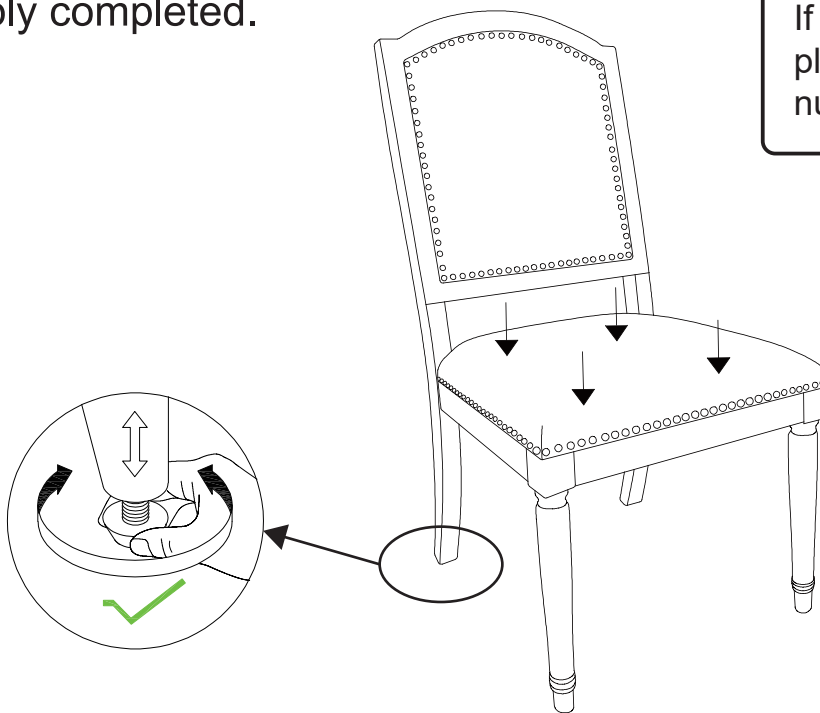

# WARRANTY

1. We strive to offer high-quality products, and we also try our best to satisfy each and every customer that orders from us with product or service as needed.
2. We provide 30 days warranty starting from the time you receive the item. Each customer must provide a record of their order such as the order number, or item receipt for any items that are out of the warranty period you may also still receive.
3. Replacement parts by purchasing them with our company if they are available.

For return, please check the return policy with the retailer or market place you bought from.

Appreciate your purchasing from us.  
Pop up your life by our furniture piece!