

# Assembly Instructions

## COFFEE TABLE

CAUTION: You must read this before you proceed.

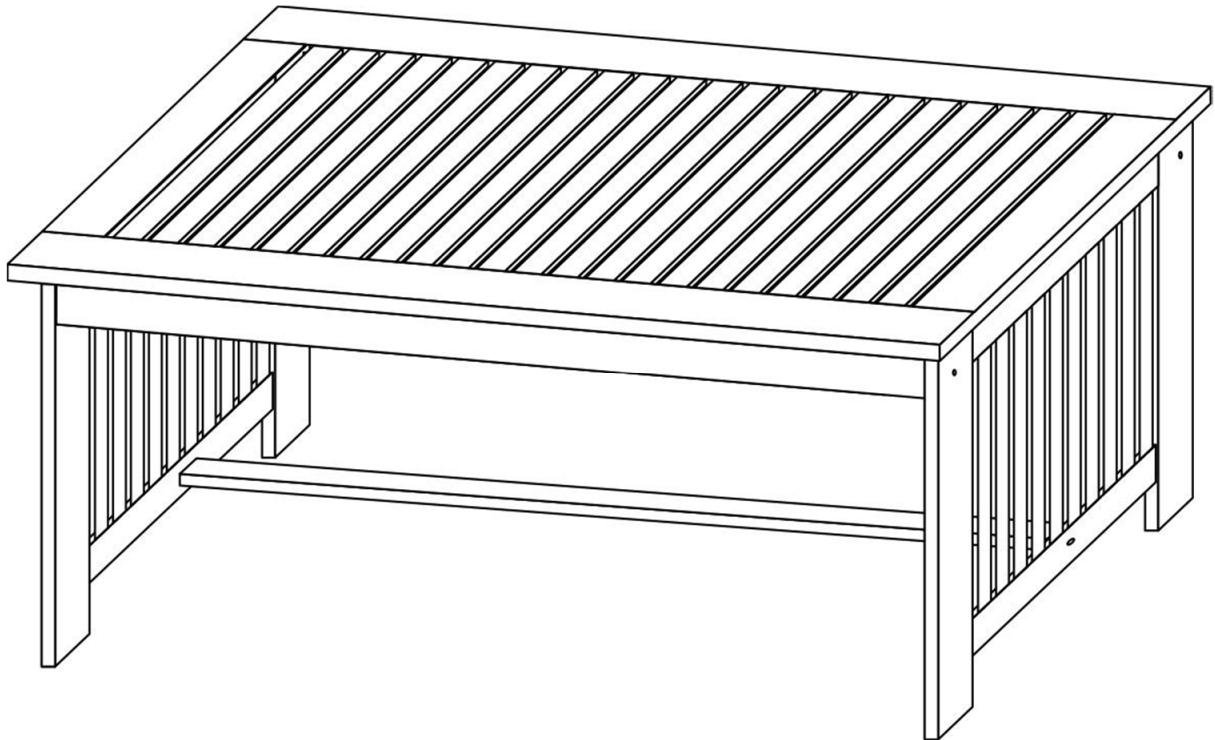





**CAUTION** : This Table is NOT a TOY.

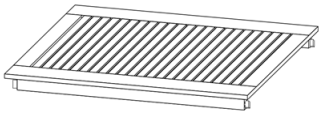

Keep your child / children at bay in the process of assembly.

For turning the Table and to prevent damage to the Table, 02 persons may be needed to execute this action.

## Parts List

No.	Picture	Description	Qty
A		Table Top	1
B1		Right Side Panel	1
B2		Left Side Panel	1
C		Support Bar	1

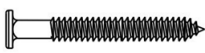



## Hardware

No.	Picture	Description	Qty
①		Screw (M7*70mm)	7
②		Allen Key(4*98mm)	2

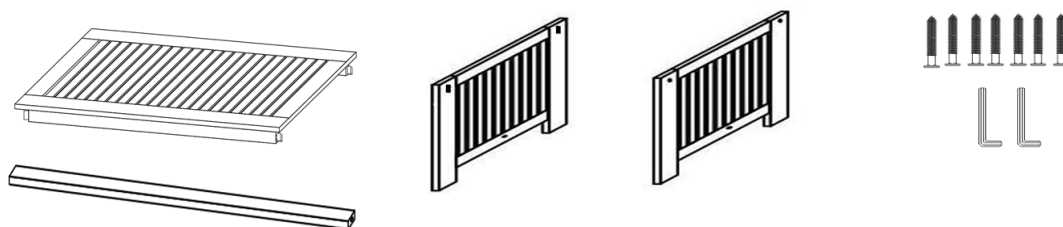
## Assembly Preparation

Before Beginning Assembly:



-  • Read instructions, cover to cover-
-  • Have 2 adults on hand for assembly-
-  • Do not assemble on flooring or carpet-
-  • Assemble on a clean non-marring surface (packing foam)-
-  • Save all packaging until finished-

# Assembly Steps

## OVER VIEW

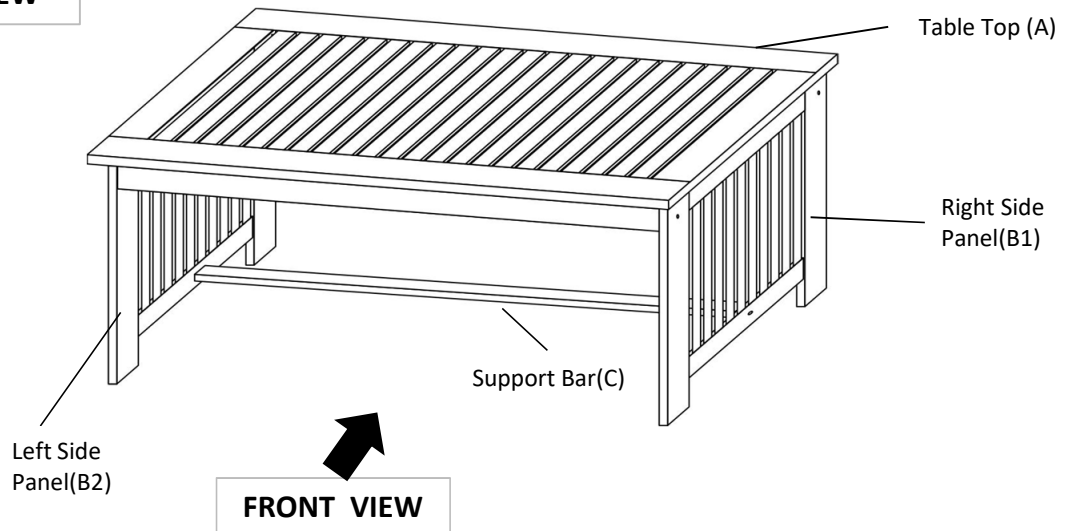

This Table has multiple parts and may require up to some 30 minutes to assemble. To give you an overview of the Table, the above picture is to help you put the various parts into perspective. Please read through the instructions here below to familiarise the parts and steps before assembly.

## Step 1

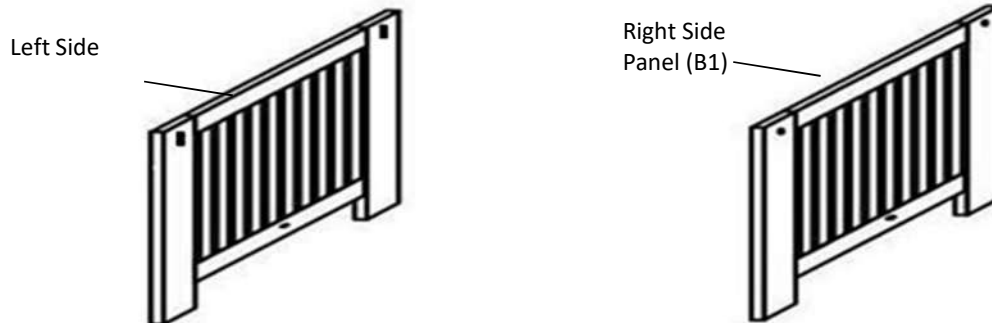

Put the Right side Panel(B1) &Left Side Panel(B2) on the table for easiest assembling position.

## Step 2

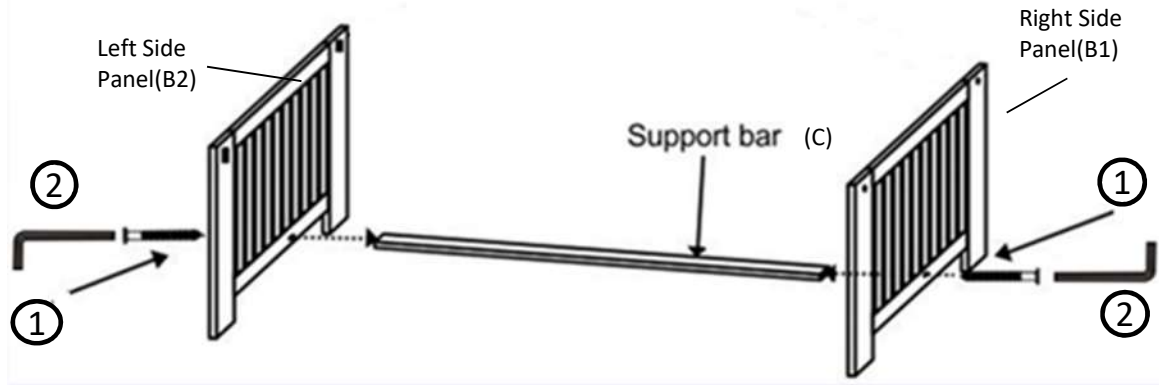

Using Screws (①) to connect the two Side Panel (B1&B2) with Support Bar(C) as shown.

**Do not tighten completely.**

## Step 3

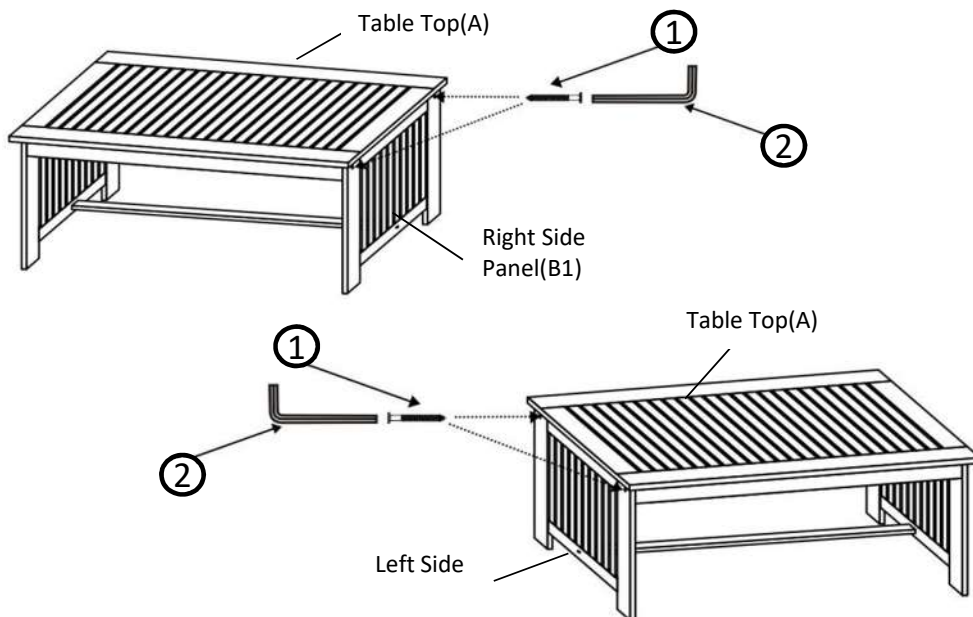

Using Screw (①) to connect Right Side Panels (B1) to Table Top (A).

Fix the Right Side Panel B1 by using Screw (①) with Allen Key (②).

Repeat the same process for the Left side Panel (B2)

**Do not tighten completely.**

## Step 4

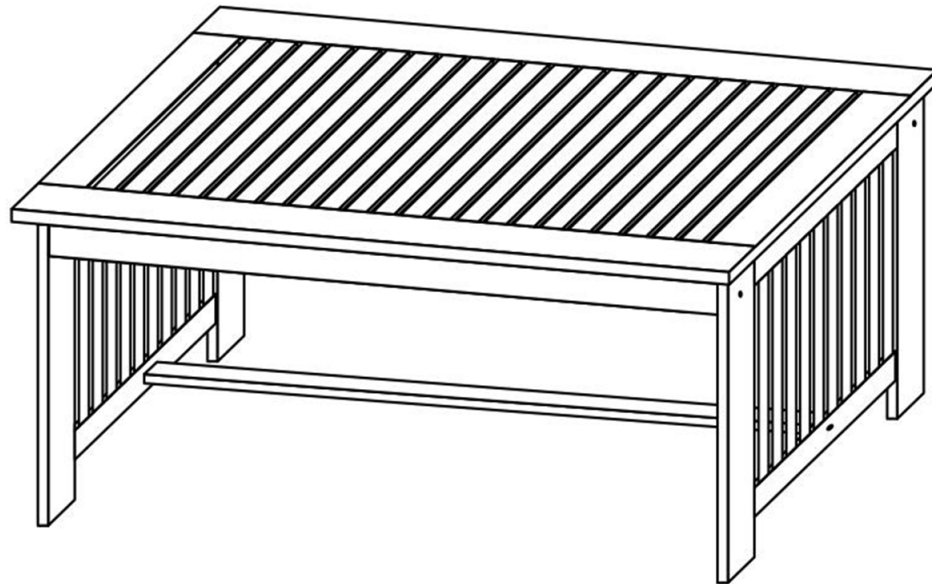

Inspect it and make sure all parts are adequately connected.  
In a sequential manner, ensure all screws are fully locked into position and secured.  
The Coffee Table is ready to be used.

**CAUTION : When tightening these screws, tighten sequentially.**









**DO NOT tighten any screw fully and then towards the next one.**

**This would cause the frame to warp.**

**If there is still wobbles, loosen the screws and execute this same drop tests.**

**IF TABLE IS NOT STABLE , IT COULD LEAD TO DAMAGING THE PRODUCT.**

## Care & Maintenance

- ⊘  ● Do not put hot items directly on furniture surface.
  - ⊘  ● Do not clean furniture with harsh cleansers or polish.
  - ✓  ● To obtain the longest lifespan of your outdoor products, minimizing exposure to direct sunlight is recommended.
  - ⊘  ● Children should not climb or jump on the furniture.
  - ⊘  ● Do not write on furniture without a padded barrier to protect the surface.
  - ✓  ● To obtain the longest lifespan of your outdoor products, avoid extended and lengthy exposure to rain, snow, and direct sunshine. Whenever possible cover the product and /or place under patio or awnings.
  - ⊘  ● Not for commercial use. For residential use only.
  - ⊘  ● Stains may be removed with mild soap solution and damp cloth.
  - ✓  ● Dust and pick-up spills using a clean, non-colored, lint-free cloth .
-