

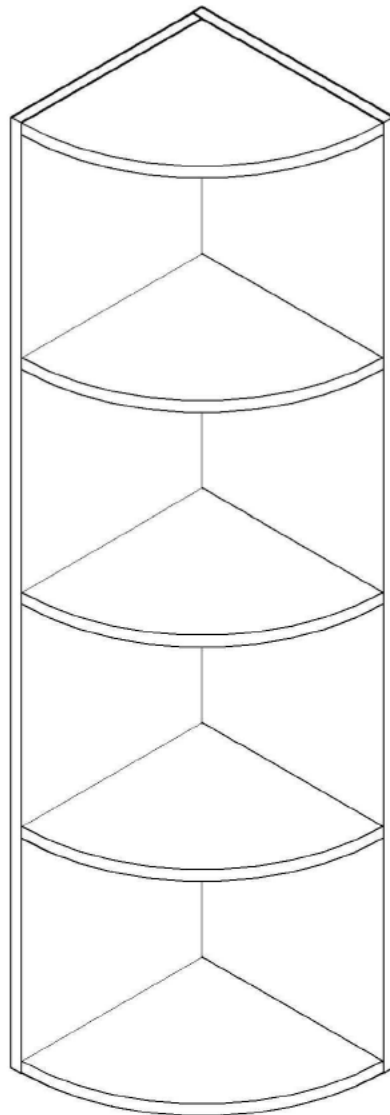







Wall Corner 4 Tiers
Shelves Bookshelf

Assembly Instructions



A		24
B		24
C		4
D		1
E		1
F		1
G		1

1

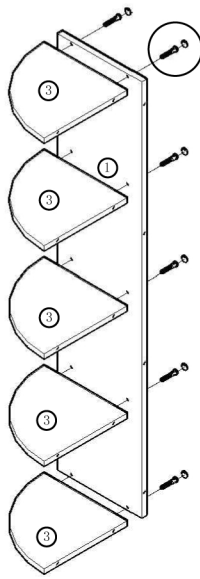

$A*10+B*10$

2

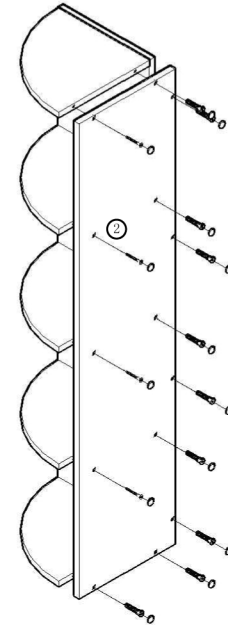

$A*14+B*14$

3

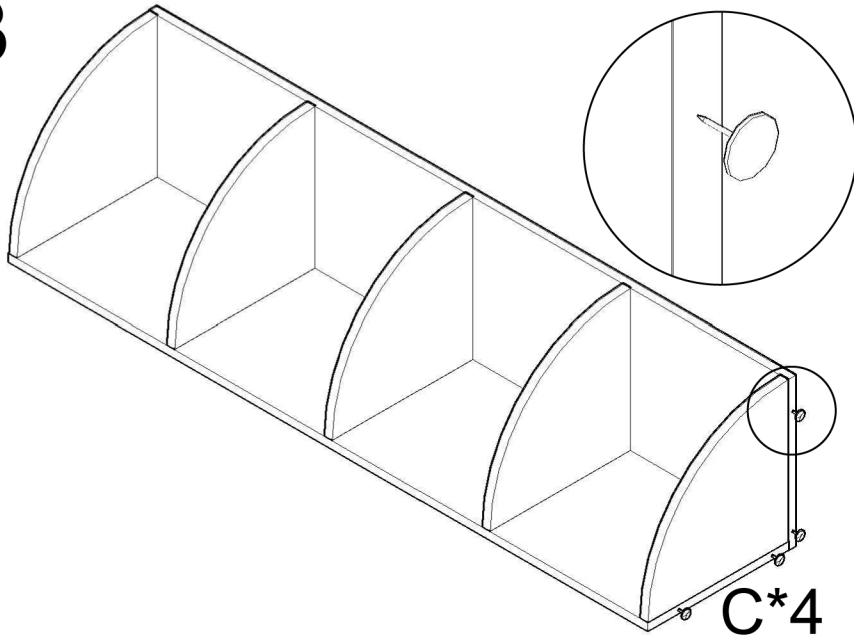

$C*4$

4

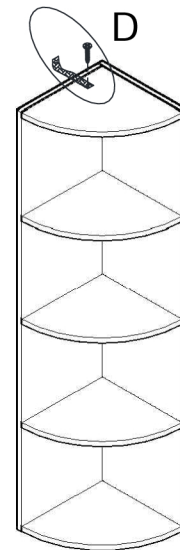
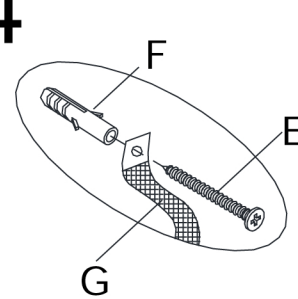

$D*1+E*1+F*1+G*1$