

INSTRUCTION

INSTRUCTIONS FOR USE

LAMP TBL 13IN RIB MTL SHADE TOUCH LED

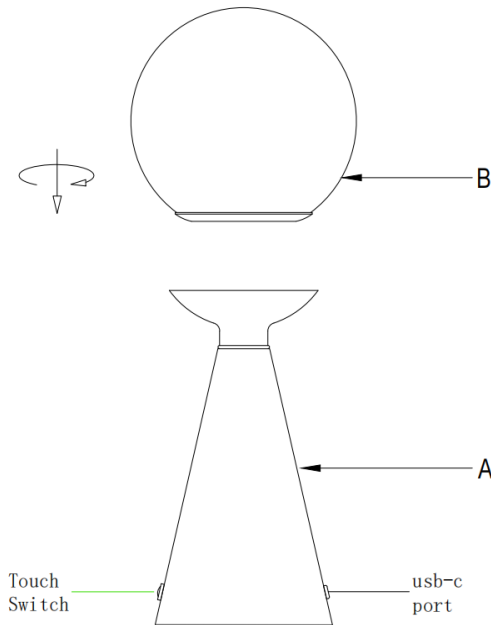

A



X 1

B

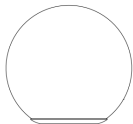

X 1

C



X 1

Installation instructions

1. Unpack all parts from cartons carefully.
2. Install the glass shade (B) on the lamp body (A) with careful rotation until it is tightened.

Thank you for choosing us! We truly appreciate your business and your trust. If you have any questions or encounter any issues, please don't hesitate to reach out. Our team is committed to ensuring your complete satisfaction. We also value your feedback, as it helps other customers make informed decisions. If you're happy with your purchase, we'd be grateful if you could take a moment to leave a brief product review on the platform where you made your purchase. Once again, thank you for choosing us. We look forward to serving you again!

Best regards,
The Support Team

INSTRUCTION

INSTRUCTIONS FOR USE

LAMP TBL 13IN RIB MTL SHADE TOUCH LED

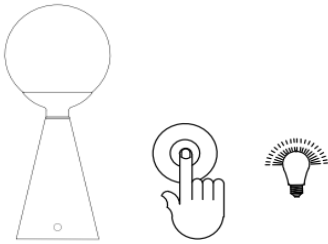

Turn on the lamp by touching the middle of the sensor on lamp.

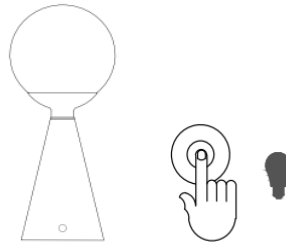

Turn off the lamp by touching the middle of the sensor when light is on.

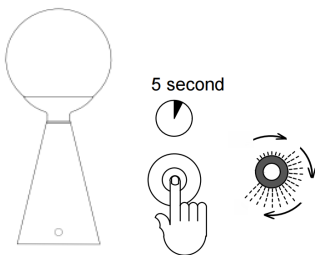

Press and hold the middle of the sensor to adjust the brightness gradually for 5 seconds or to desired level.

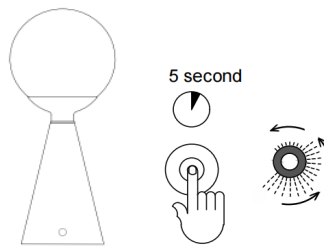

Press and hold the middle of sensor to dim the brightness gradually by 5 seconds or to desired level.

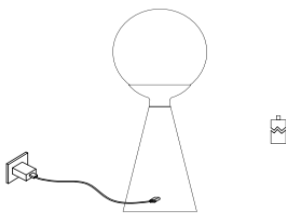

If the light on the lamp begins to dim on its own, that is when it needs to be charged.

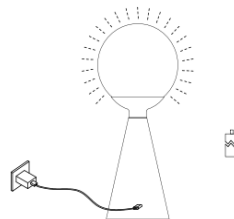

Insert the USB cable into charging port . If you see the red light, it means the lamp is charging.

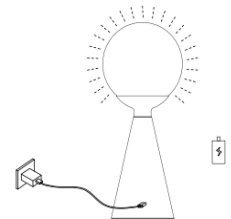

Lamp is fully charged once the light turns green.

Battery usage duration test:

Charging time: 4 hours

Duration of the dim light source on: 12 hours

Duration of the Intermediate light source on: 6.5 hours

Duration of the brightest light source on: 3 hours

INSTRUCTION

INSTRUCTIONS FOR USE

LAMP TBL 13IN RIB MTL SHADE TOUCH LED

Charge the Battery before initial use.

To correctly charge the lamp, we recommend you:

- 1) Connect the USB cable to the adaptor which comply safety regulations;
- 2) Put the plug into the electrical socket;
- 3) Place the charger into the charging port underneath the lamp shade;
- 4) When fully charged, disconnect the plug from the electrical socket.
- 5) Clean the lamp with soft dry cloth.

FCC instruction:

CAUTION: Changes or modifications not expressly approved by the party responsible for compliance could void the user's authority to operate the equipment.

Note: This equipment has been tested and found to comply with the limits for a Class B digital device, pursuant to part 15 of the FCC Rules. These limits are designed to provide reasonable protection against harmful interference in a residential installation. This equipment generates, uses and can radiate radio frequency energy and, if not installed and used in accordance with the instructions, may cause harmful interference to radio communications. However, there is no guarantee that interference will not occur in a particular installation. If this equipment does cause harmful interference to radio or television reception, which can be determined by turning the equipment off and on, the user is encouraged to try to correct the interference by one or more of the following measures:

- Reorient or relocate the receiving antenna.
- Increase the separation between the equipment and receiver.
- Connect the equipment into an outlet on a circuit different from that to which the receiver is connected.
- Consult the dealer or an experienced radio/TV technician for help.