

# ASSEMBLY INSTRUCTIONS

## **before you begin**

1. Check for damaged or missing parts.
2. Use the carton as a working surface to prevent product damage during assembly.
3. Gather all tools prior to assembly.

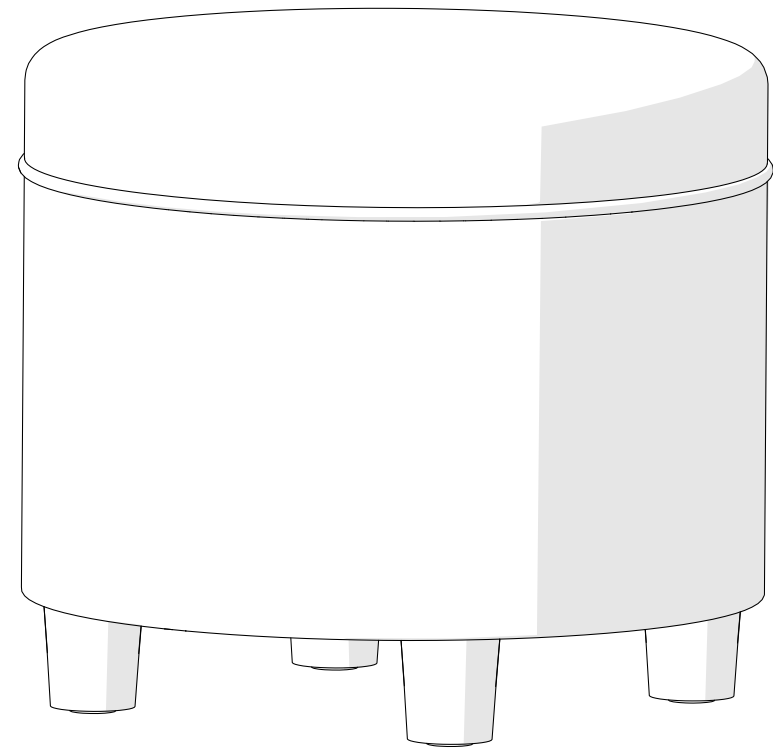

# hardware

---

(A) x 4

5/16" x 2 3/4"  
round hex screw

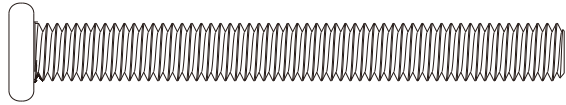
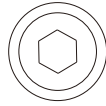

(B) x 4

5/8" flat washer

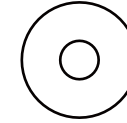

(C) x 1

1/4" Ball end  
Hex wrench

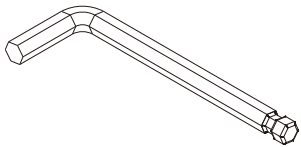

(D) x 4

$\phi$  1 1/8" x 1/8"  
Self adhesive foot pad



ITEM DESCRIPTION QUANTITY



①	cover	1
②	box	1
③	leg	4

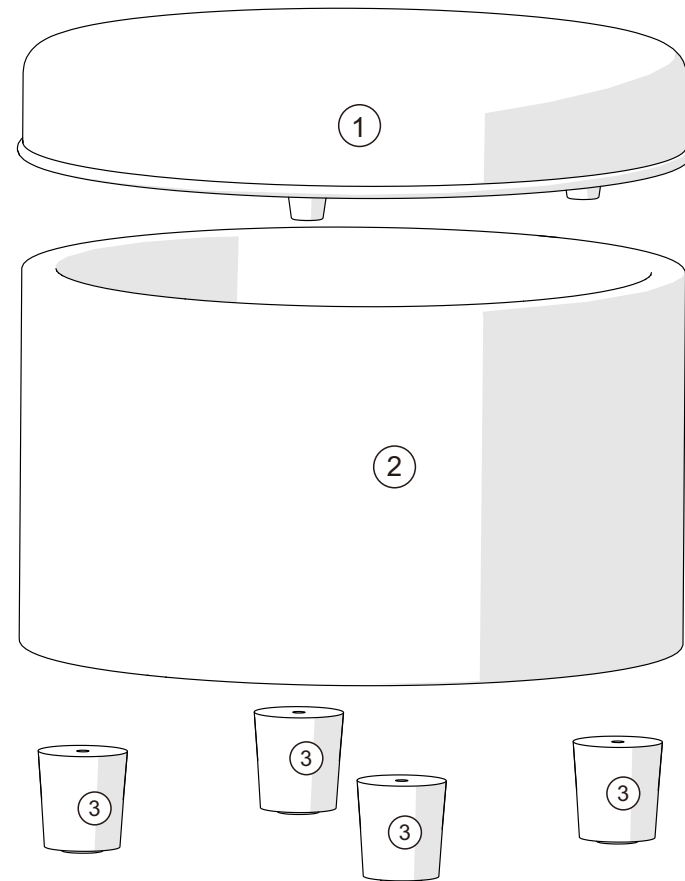

# step 1.

---

1

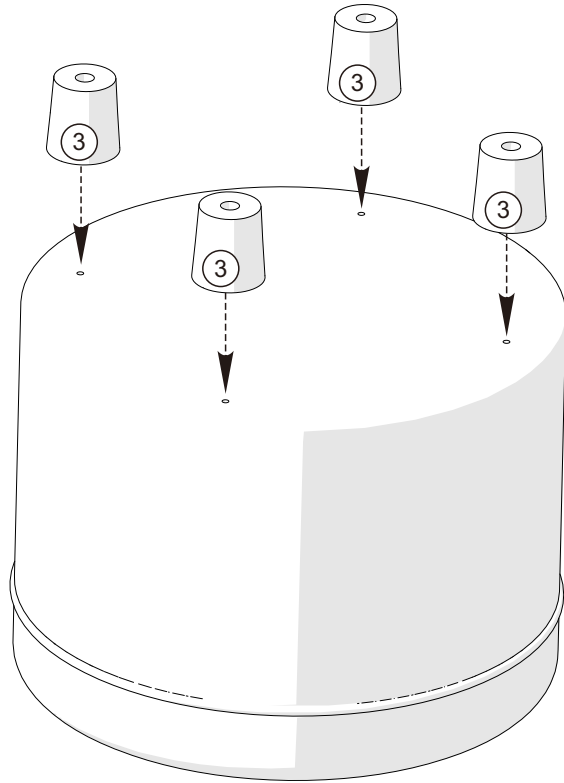

2

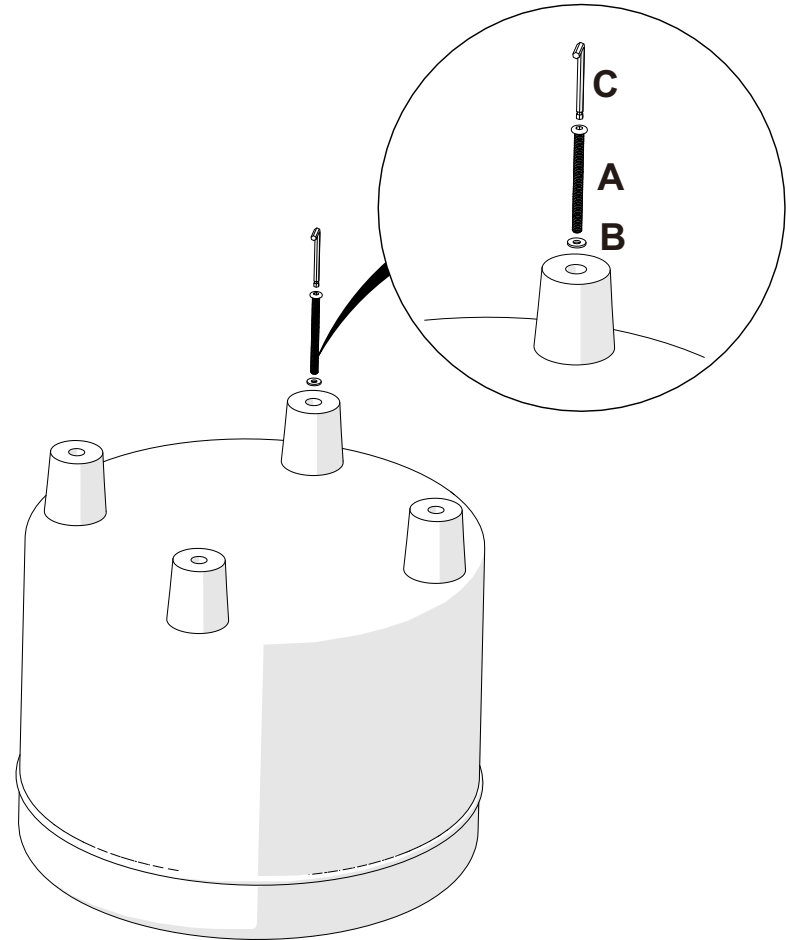

---

(A) x 4

5/16" x 2 3/4"  
round hex screw

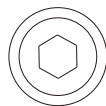
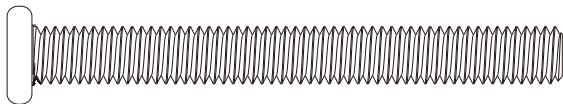

(B) x 4

5/8" flat washer

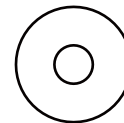

(C) x 1

1/4" Ball end  
Hex wrench

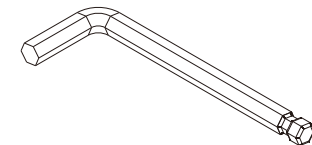

## step 2.

---

1

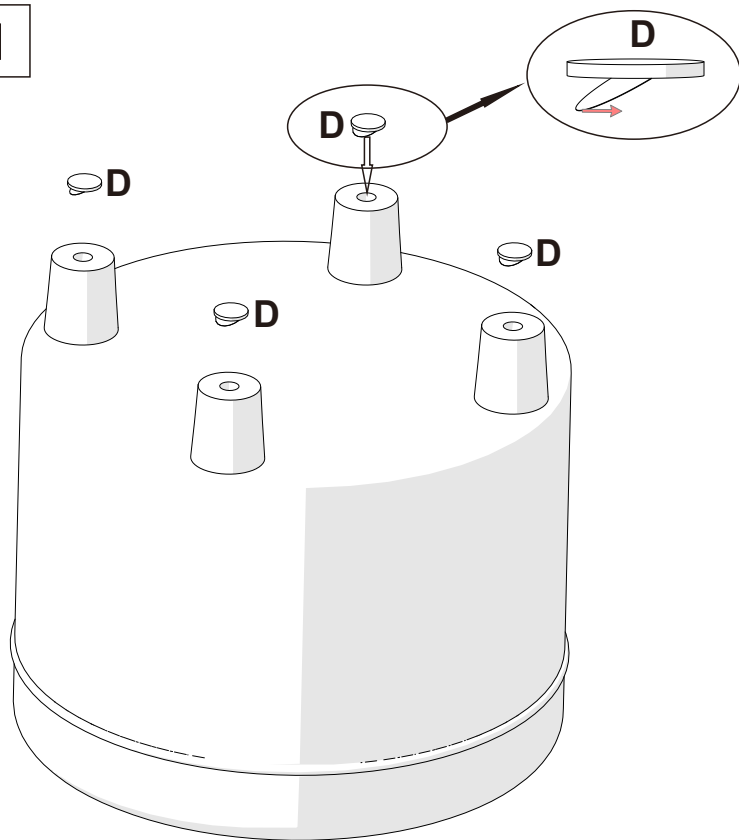

2

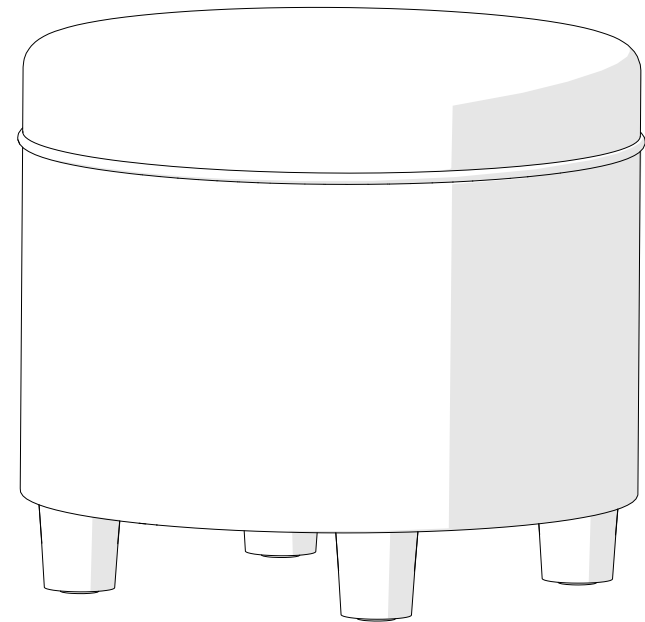

---

(D) x 4

$\phi$  1 1/8" x 1/8"  
Self adhesive foot pad

