

INSTRUCTION MANUAL

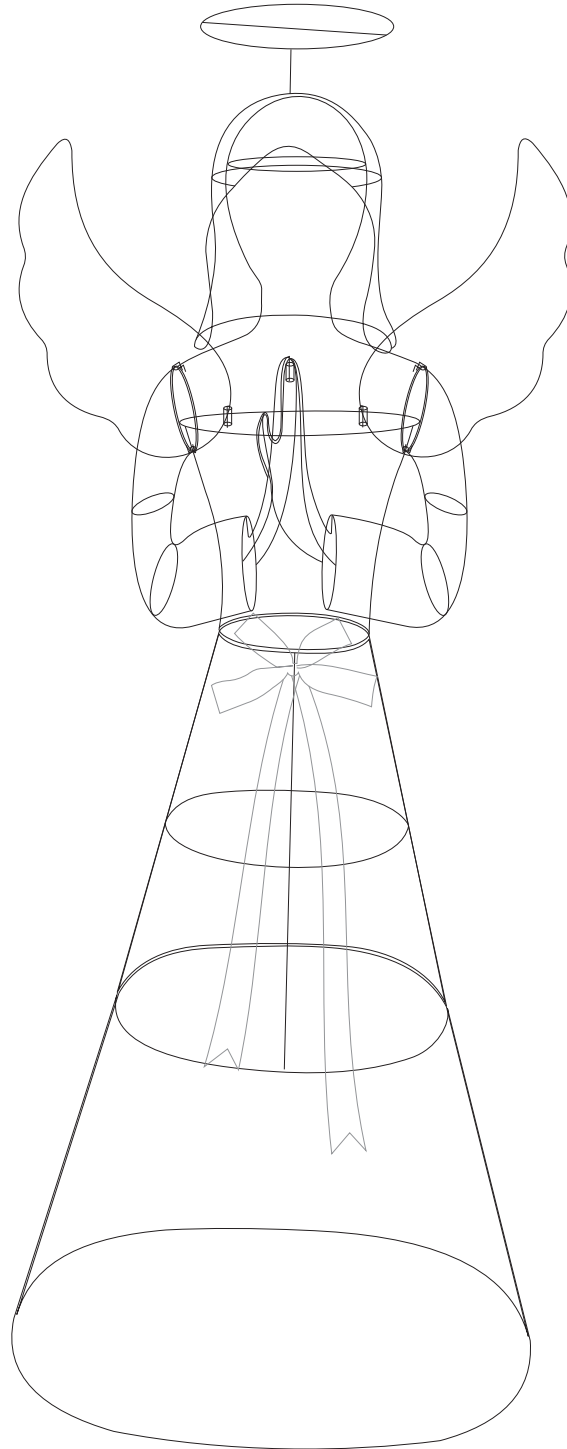

Thank you for shopping with us!

If any parts is missing, broken upon receipt or you need any help from us. For the FASTEST solutions, please FIRSTLY CONTACT US

IMPORTANT SAFETY INSTRUCTIONS

When using electrical products, basic precautions should always be followed including the following:

- a) **READ AND FOLLOW ALL SAFETY INSTRUCTIONS.**
- b) This seasonal use product is not intended for permanent installation or use.
- c) This item is suitable for indoor use and outdoor use only when the weather is fine.
- d) Do not mount or place near gas or electric heaters, fireplaces, candles or other similar sources of heat.
- e) Do not secure the wiring of the product with staples or nails, or place on sharp hooks or nails.
- f) Do not let lamps rest on the supply cord or on any wire.
- g) Unplug the product when leaving the house, when retiring for the night, or if left unattended.
- h) This is an electric product-not a toy! To avoid risk of fire, burns, personal injury and electric shock it should not be played with or placed where small children can reach it.
- i) Do not use this product for other than its intended use.
- j) Do not hang ornaments or other objects from cord, wire, or light string.
- k) Do not close doors or windows on the product, its wires, or on extension cords as this may damage the wire insulation.
- l) Do not cover the product with cloth, paper, or any material not part of the product when in use.
- m) This product is equipped with non-replaceable type lamps. Do not attempt to replace the lamps.
- n) Use only with the Class 2 Adaptor provided with this product.
- o) Read and follow all instructions that are on the product or provided with the product.
- p) **SAVE THESE INSTRUCTIONS.**

WARNING: Risk of Fire, shock, or personal injury.

- 1) Use only with included Class 2 Adaptor.
- 2) Not for use on outlets controlled by a dimmer.
- 3) Use only on timer controlled outlets where the timer is rated for use with compact fluorescent bulbs (CFL bulbs).
- 4) Do not attempt to replace bulbs, they are not replaceable.
- 5) Do not use power adaptor if enclosure is broken or cracked, discard unit.
- 6) Do not use with a voltage converter.

Use and Care Instructions

- a) Before using or reusing, inspect product carefully. Discard any products that have cut, damaged, or frayed wire insulation or cords, cracks in the lamp holders or enclosures, loose connections, or exposed copper wire.
- b) When storing the product, carefully remove the product from wherever it is placed, including trees, branches, or bushes, to avoid any undue strain or stress on the product conductors, connections and wires.
- c) When not used, store neatly in a cool, dry location protected from sunlight.
- d) Do not impact or drop the adaptor, if enclosure is broken or cracked, discard product.
- e) The product and the adaptor shall not be installed within 10 feet of a pool, spa, fountain, or other areas of standing water.

Installation Instructions (The adaptor will be pre-attached before shipping)

1. Read all enclosed Safety and Instructions before starting.
2. Carefully remove product from packaging, be sure not to cut any wires.
3. Plug adaptor into wall outlet, lights should come on.

Troubleshooting Instructions

If lights do not work:

- a) Make sure item is connected to the adaptor. Make sure connectors are fully inserted into the transformer, and tight.
- b) Make sure the adaptor is plugged into a 120V AC outlet.
- c) Make sure the outlet has power (check to see if any switches control the outlet) and not connected to a dimmer switch.
- d) If used on a timer controlled outlet, make sure the timer is rated for use with compact fluorescent bulbs (CFL bulbs) or LED bulbs, if not, use on a different circuit/outlet.
- e) If plugged into a GFCI protected outlet, reset the GFCI in case it activated.

FCC Information

Note: This equipment has been tested and found to comply with the limits for a Class B digital device, pursuant to item 15 of the FCC Rules. These limits are designed to provide reasonable protection against harmful interference in a residential installation. This equipment generates, uses and can radiate radio frequency energy and, if not installed and used in accordance with the instructions, may cause harmful interference to radio communications. However, there is no guarantee that interference will not occur in a particular installation. If this equipment does cause harmful interference to radio or television reception, which can be determined by turning the equipment off and on, the user is encouraged to try to correct the interference by one or more of the following measures:

- Reorient or relocate the receiving antenna.
- Increase the separation between the equipment and receiver.
- Connect the equipment into an outlet on a circuit different from that to which the receiver is connected.
- Consult the dealer or an experienced radio/TV technician for help.

Caution: Changes or modifications not expressly approved by the party responsible for compliance could void the user's authority to operate the equipment.

HARDWARE

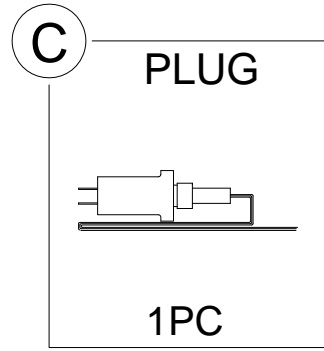
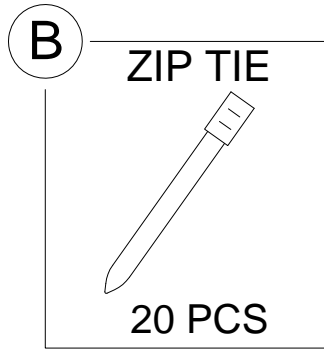
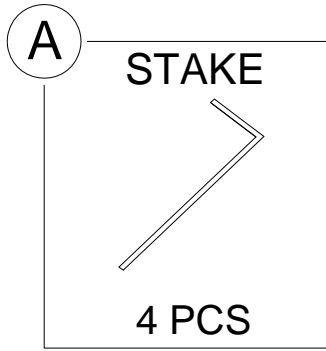

PARTS

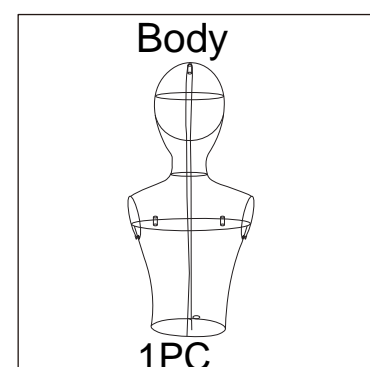
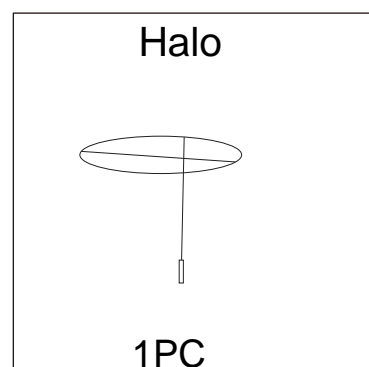
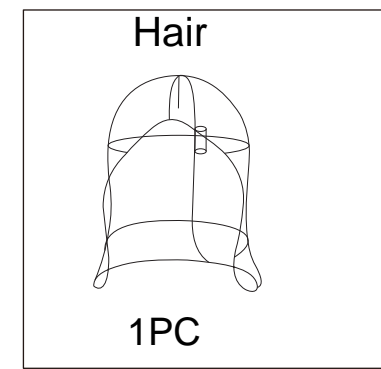
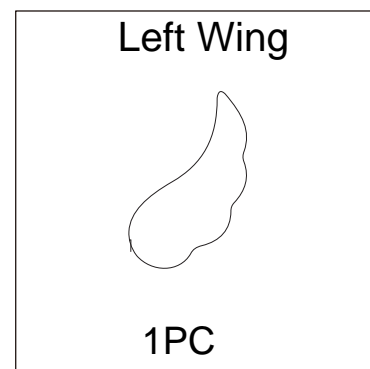
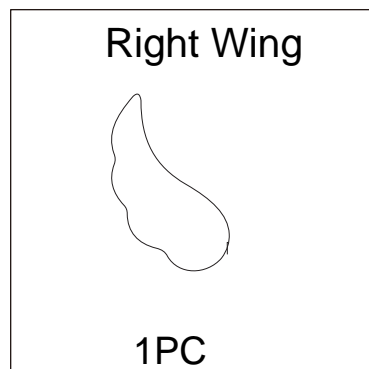
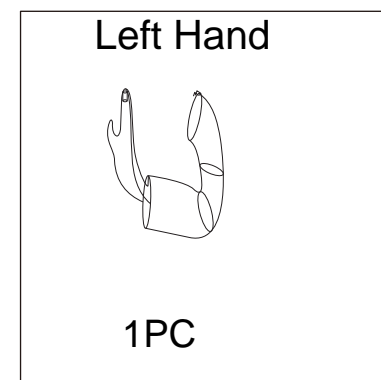
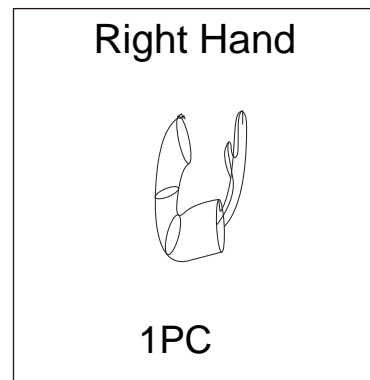
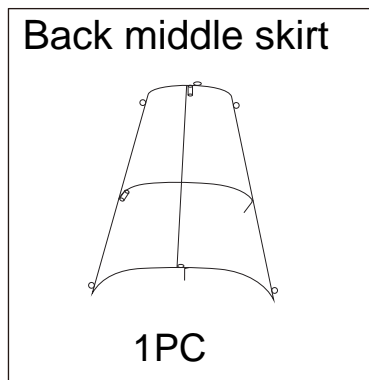
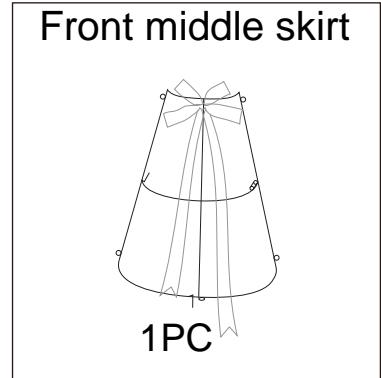
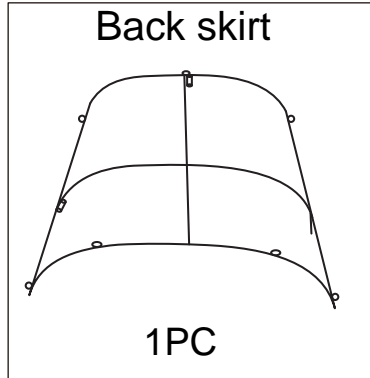
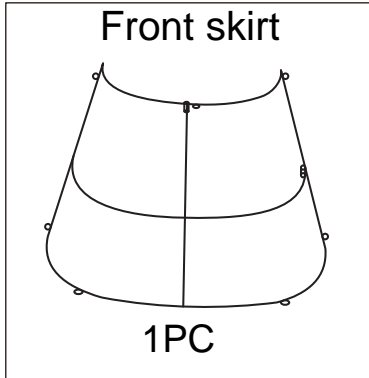

PRODUCT ASSEMBLY

- 1** Carefully remove protective wrap. Do not use a knife to avoid damaging parts or light bulbs. Put the skirt together. Secure the body with a part B zip tie.

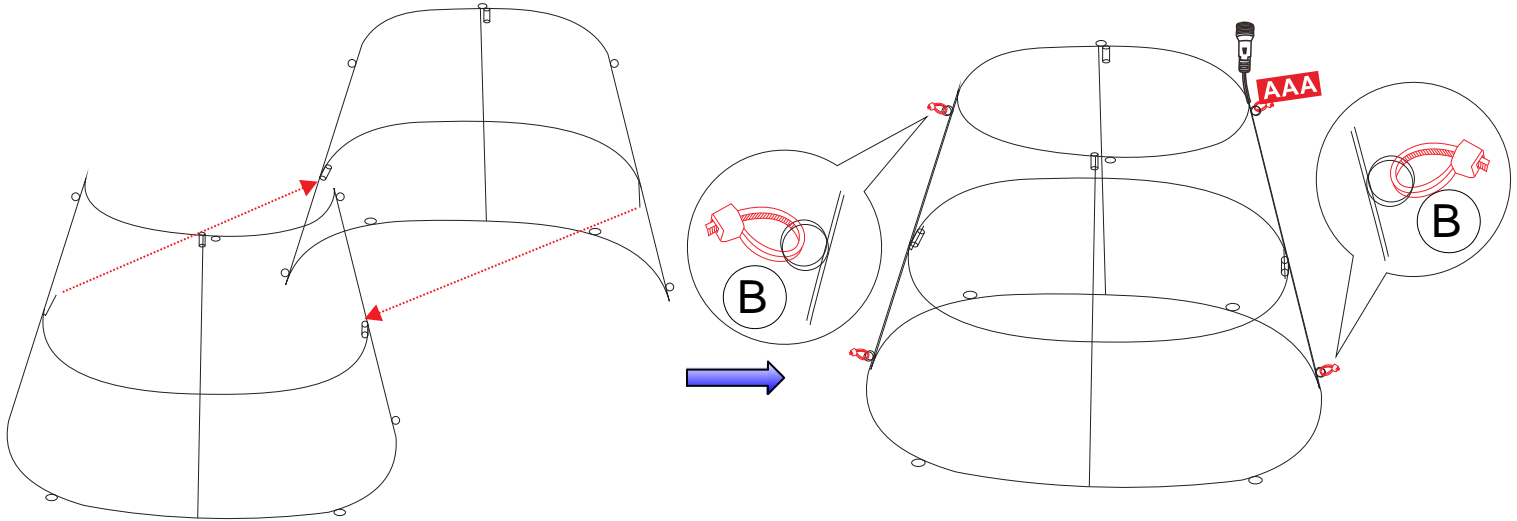

- 2** Put the skirt together. Secure the body with a part B zip tie.

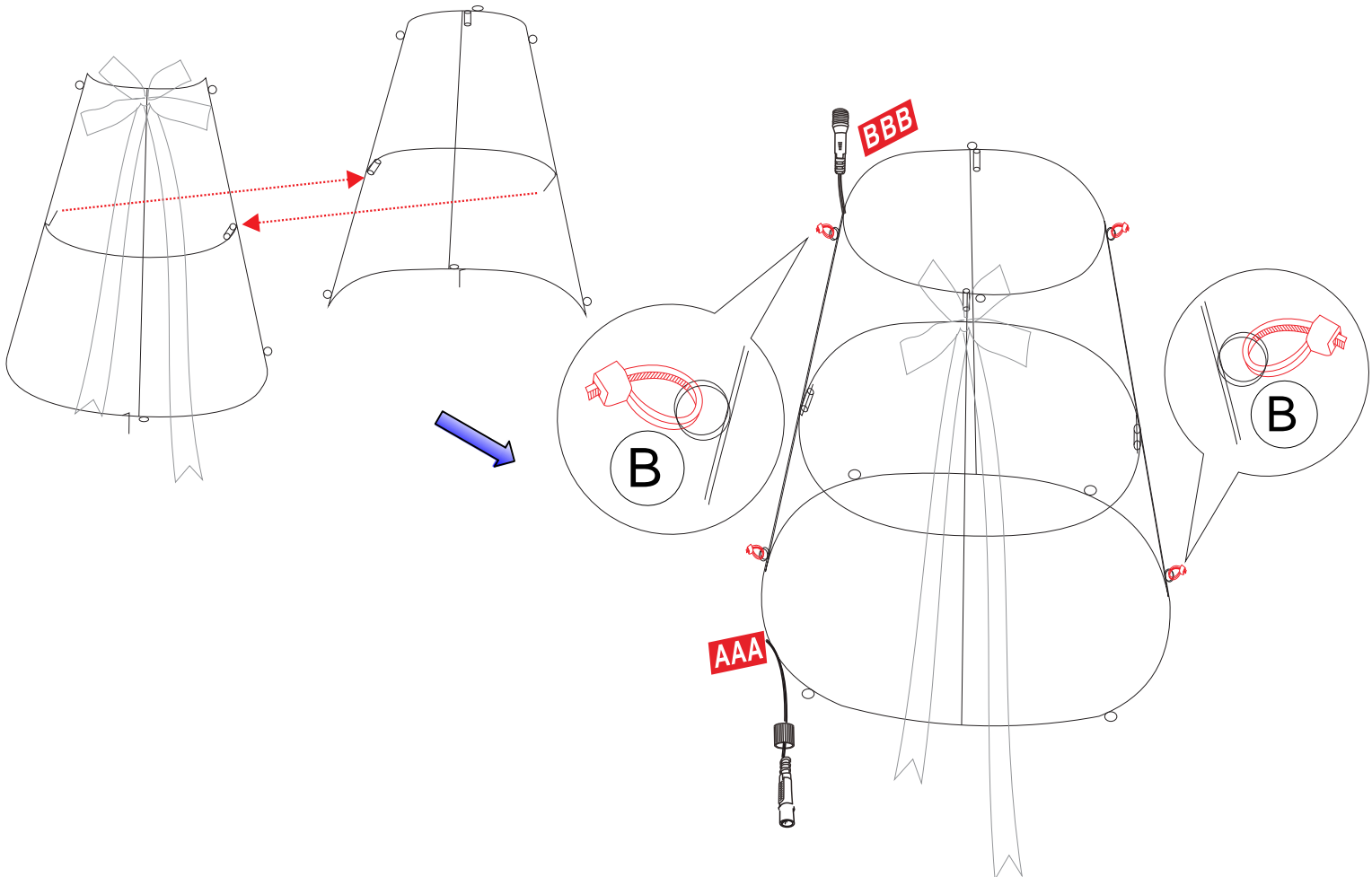

PRODUCT ASSEMBLY

- 3** Put the two parts together. Secure the body with a part B zip tie.

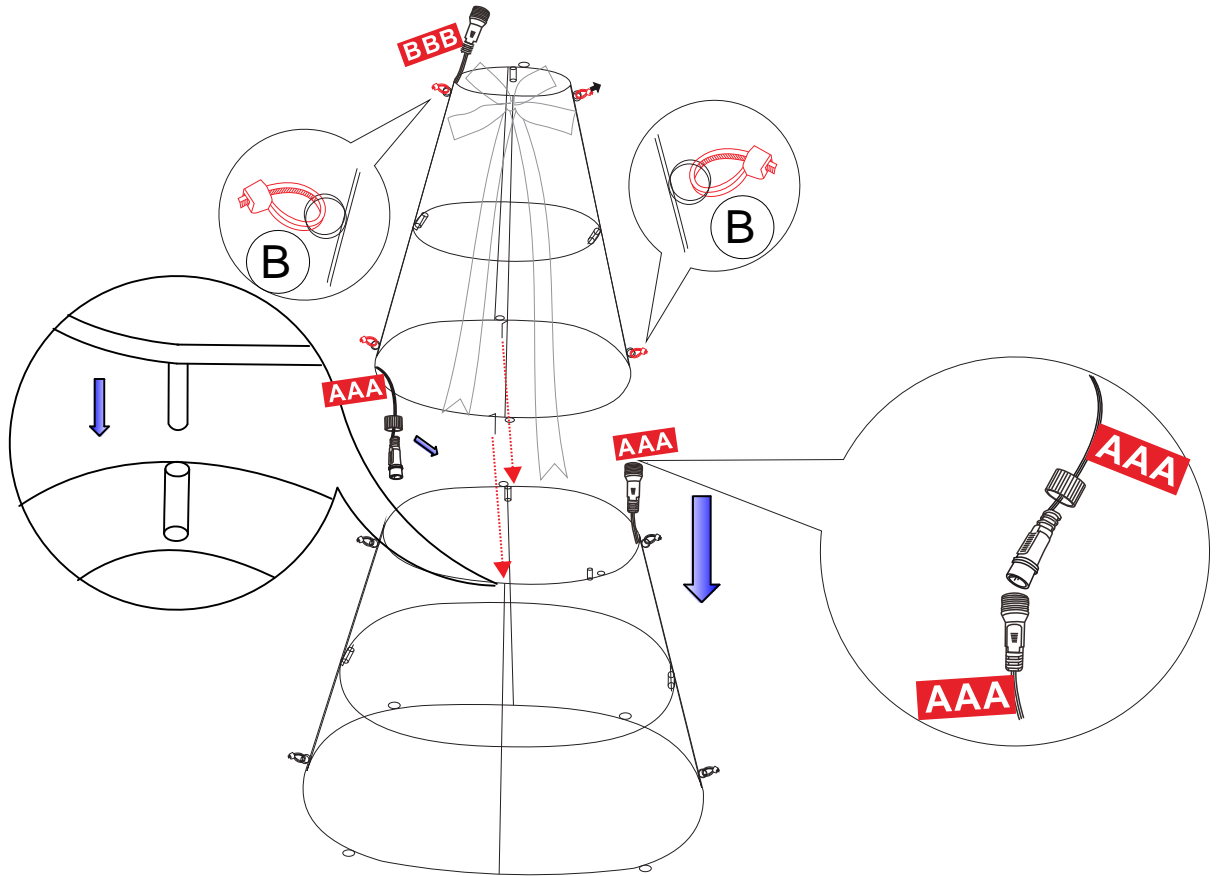

- 4** Insert the Angell body into the skirt.
Secure the skirt with a part B zip tie.

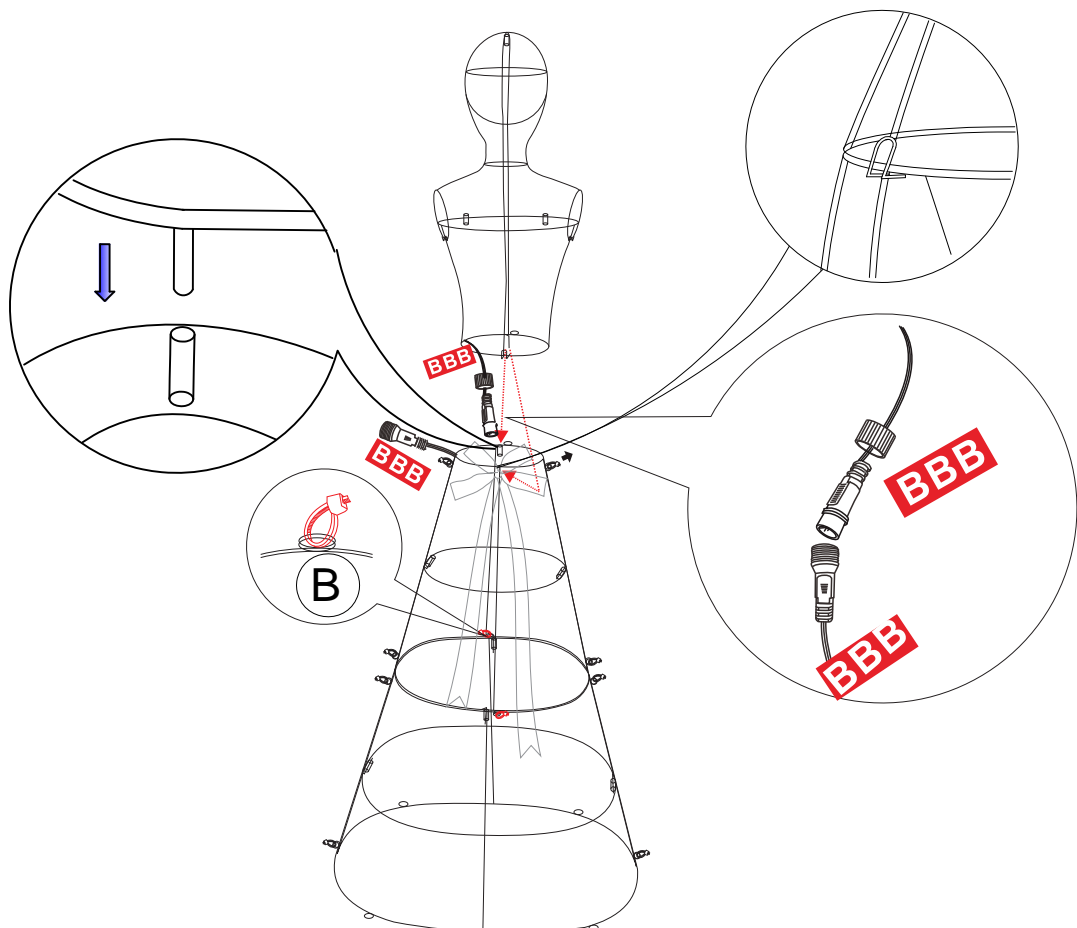

PRODUCT ASSEMBLY

- 5** Insert the Angell hand into the body.

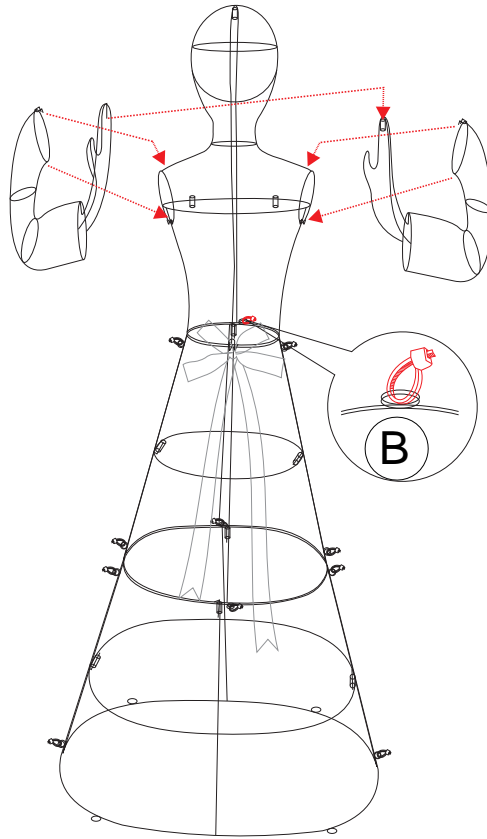

- 6** Insert the Angell wing into the body.
Insert the Angell hair and halo into the head.

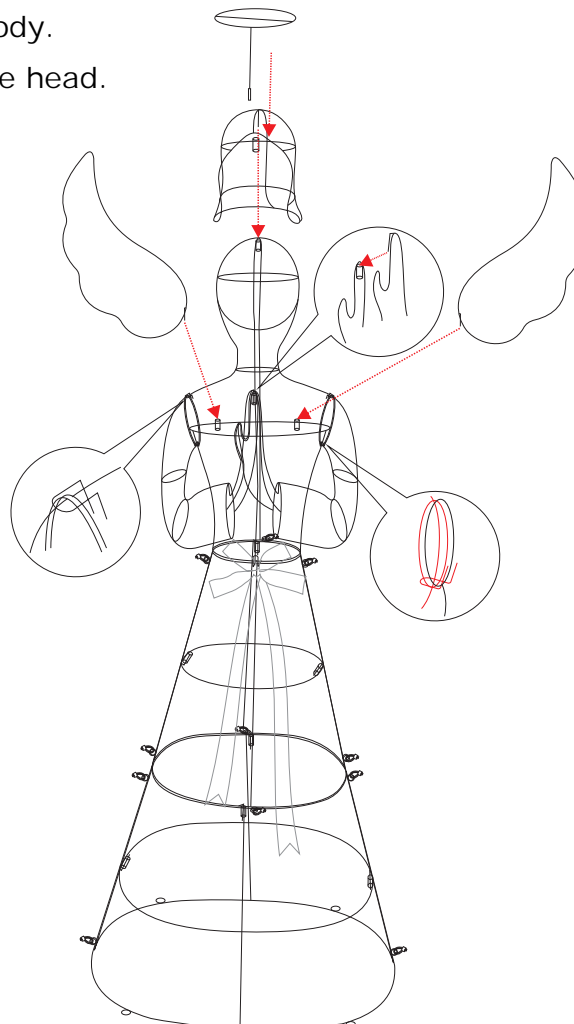

PRODUCT ASSEMBLY

7

Secure the Angell to the ground with 4 part A stakes.

Plug into a wall outlet to turn on lights.

