

CARE AND MAINTENANCE









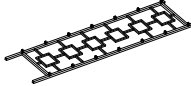
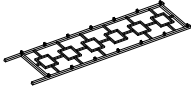

Wipe clean with a soft, dry cloth. Test the cleaning method on a hidden area before using them over the entire area.

NOTICE

- * Please make sure that you have all parts indicated before you begin assembly of this item.
- * This item should be assembled on a soft surface to prevent scratching the finished product during assembly.
- * This item may require periodic tightening.
- * Do not tighten bolts until completely assembled.

Product Dimensions: 36"W*16"Dx72"H

Part List and Hardware List

PIECE	DESCRIPTION	PICTURE	QUANTITY
A	Left Side Frame		1x
B	Right Side Frame		1x
C	Connecting bar		12x
D	Connecting bar		2x
E	Support Bar		4x
F	Glass Shelf		7x
H1	Allen Bolt	 1/4"x5/8"	28x
H2	Allen Bolt	 1/4"x1-1/4"	8x
H3	Suction Cup	 ϕ 19mm	28x
H4	Allen Key	 M4	1x
H5	Anti-Tip Hardware		2x

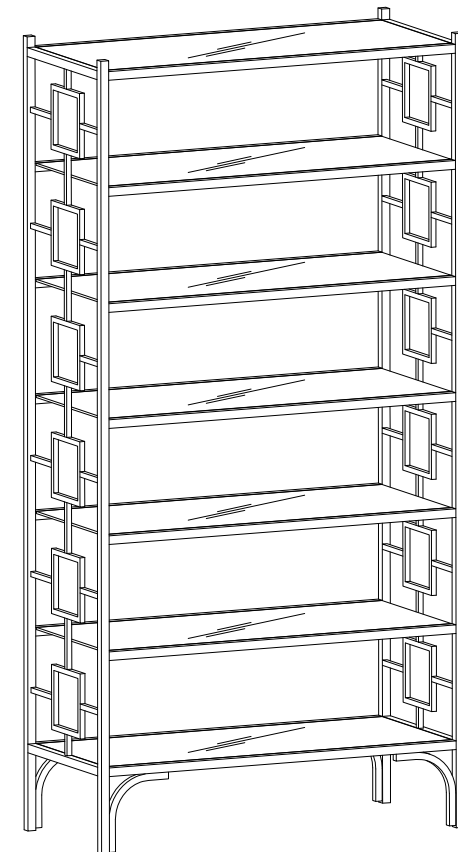

PREPARATION

Before beginning assembly of product, make sure all parts are present. Compare parts with package contents list and hardware contents list. If any part is missing or damaged, do not attempt to assemble the product.

Estimated Assembly Time: 30 minutes.

Tools Required for Assembly (included): Allen Key

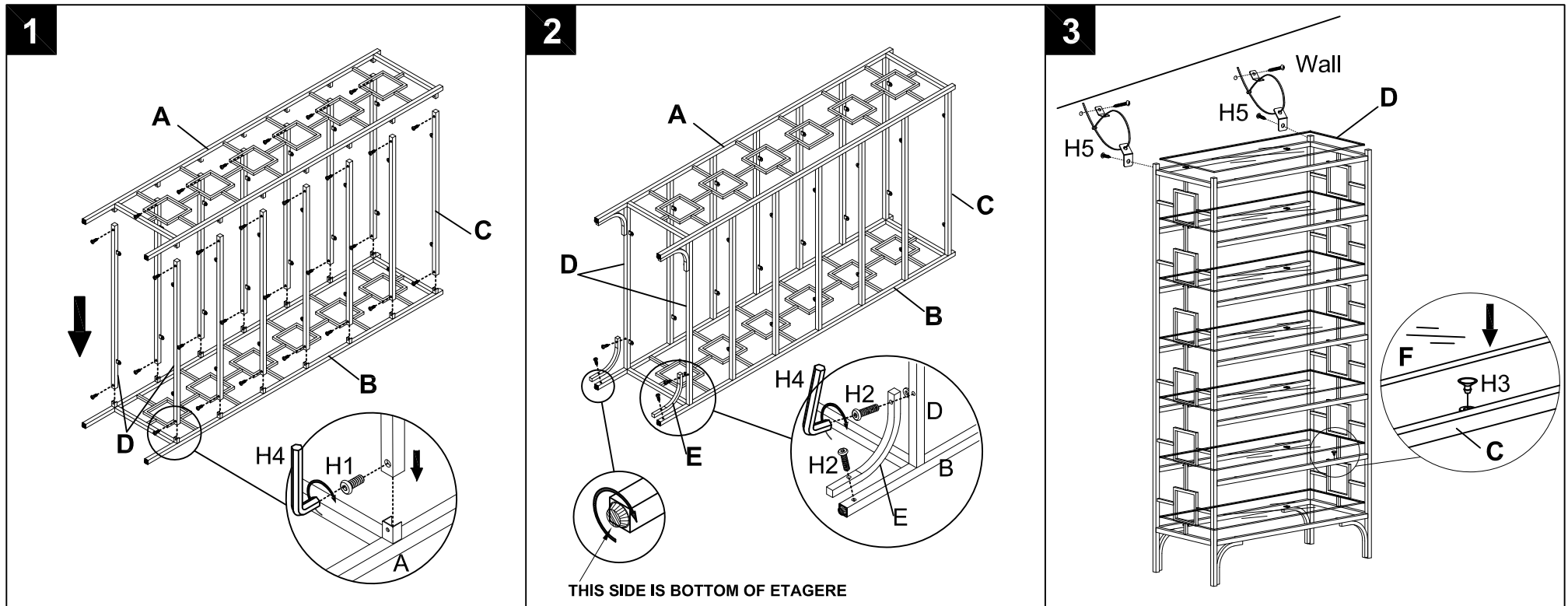

Step 1

Place left side frame (A) and right side frame (B), then attach 14*connecting bars (C) on both side frames and aligning, Use Allen Key (H4) to lock 28*Allen bolts (H1) from the underneath of connecting bars(C).as picture.

Step 2

Attach 4*support bars (D) on the bottom side of assembled etagere and aligning, Use Allen Key (H4) to lock 8*Allen bolts (H2), as picture.

Step 3

Straighten up the assembled etagere, place 28*suction cups (H3) on 7 metal shelves frame in position, and place 7*Glass shelves (F) on 7 shelves separately. Following the Installation Instructions of anti-tipping to fix the rack with wall by 2 straps, Assembly is completed.