

# Sofa & Couch

Assembly instructions

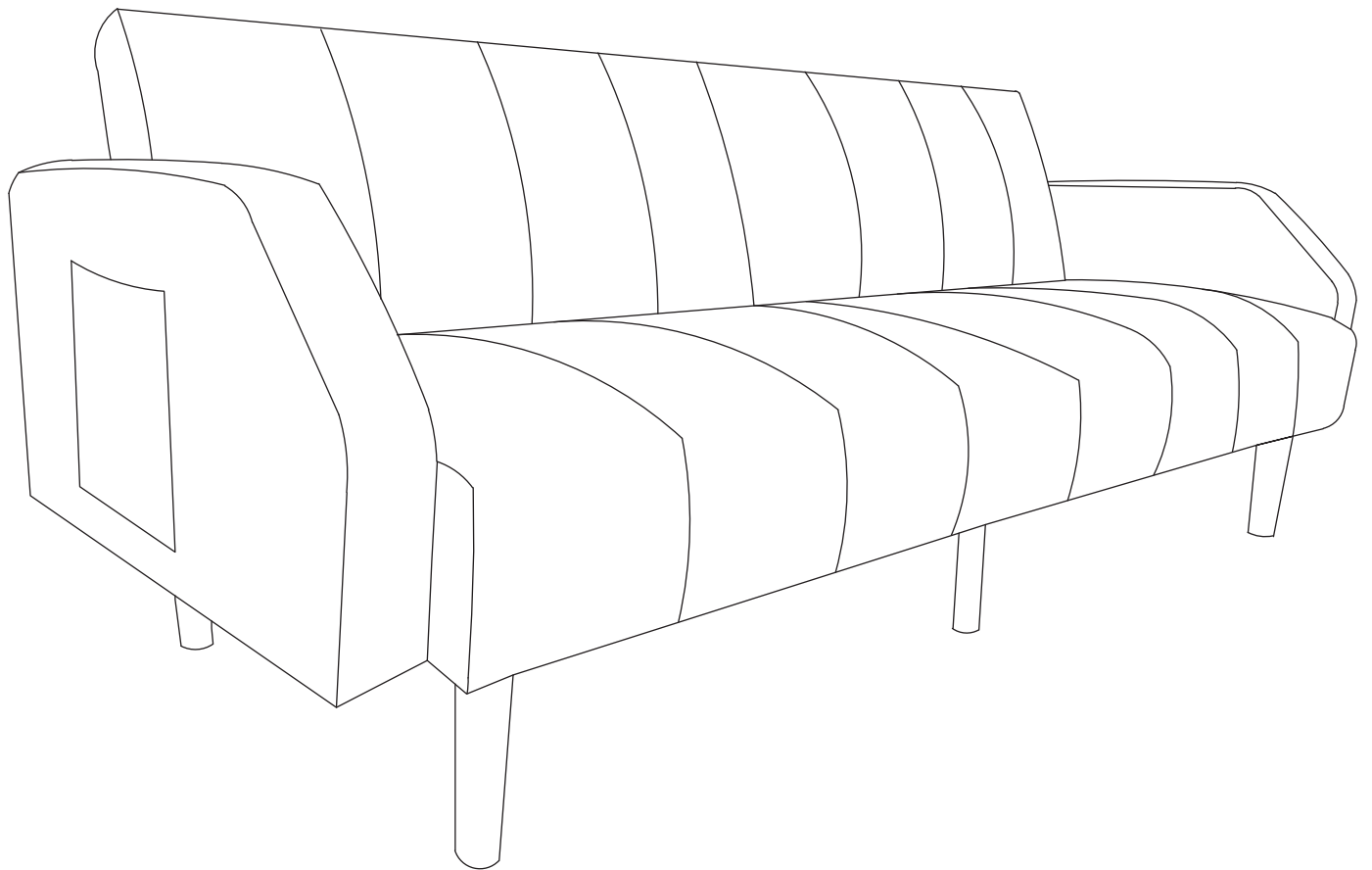

Weight Limit: 700 lb / 317 kg

Thank you for purchasing our product! We guarantee that the materials and craftsmanship of this product are defect-free!

## **Please Read Before Starting Assembly**

1. Follow the assembly Steps one by one, and do not skip any Steps.
2. Assemble the product in a spacious area, keeping a safe distance from infants and children. It's advisable to place protective packaging on the floor before assembly to safeguard your flooring and the product.
3. Thoroughly check to ensure that all connections (screws, bolts, etc.) are properly tightened.
4. If the product requires two or more people to assemble, do not attempt to install it alone, as it could pose a threat to your personal safety.

## **Caution**

1. The product you purchased may have slight variations in appearance compared to the illustrations in the assembly instructions.
2. The packaging contains plastic bags; please keep these plastic bags out of the reach of infants and children. Avoid assembling near cribs, beds, infants, or children. The thin film of these bags can adhere to the mouth and nose, leading to suffocation. After removing the product, please dispose of the plastic bags immediately or use other packaging materials. Do not reuse these plastic bags.

## **Installation Steps:**

It is recommended that this product be assembled by two or more individuals.

# Parts list

---

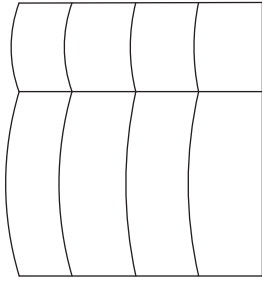

A:Left Cushion  
**1pc**

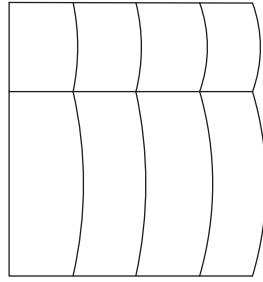

B:Right Cushion  
**1pc**

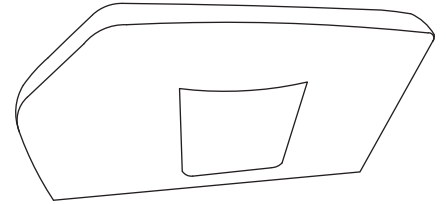

C:Right Arm  
**1pc**

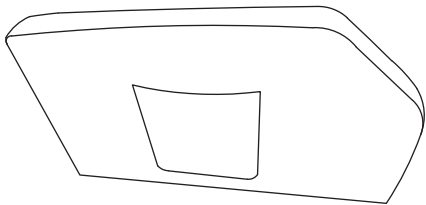

D:Left Arm  
**1pc**



E:Legs  
**4pcs**

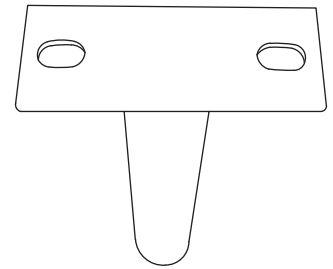

F:Legs  
**2pcs**

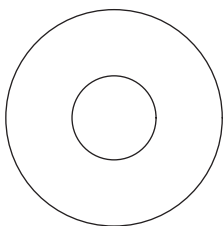

G:Round shim  
**4pcs**

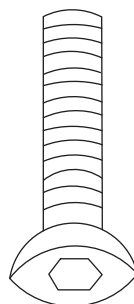

H:Screw  
**4pcs**

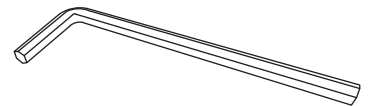

I:Allen Key  
**1pc**

## Step 1

Gently peel apart the Velcro on the sofa cushions A and B, and remove armrests C and D.

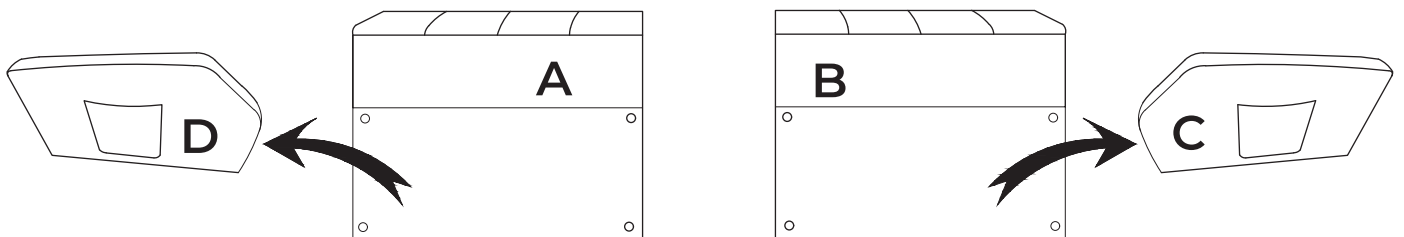
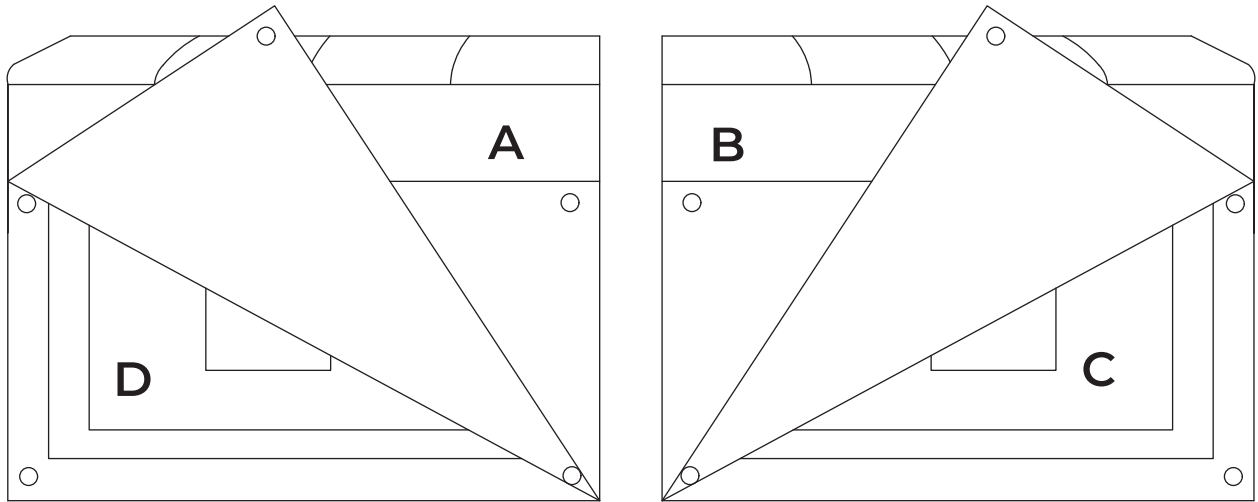

## Step 2

Place the underside of sofas A and B facing upward and snugly fit them together. Align the F (middle leg) with the holes and connect modules A and B using H (screw) + G (round washer). Make sure modules A and B are tightly joined together.

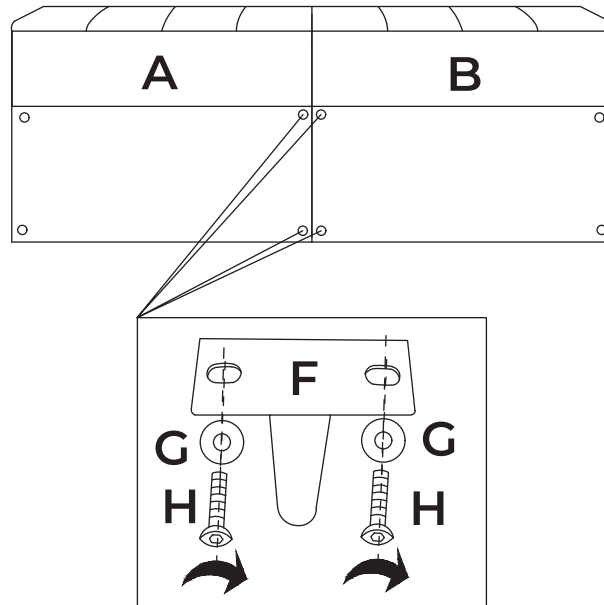

---

## Step 3

Install leg E (4 sofa legs) successively into the designated holes on the corner positions of modules A and B. Ensure all sofa legs are correctly positioned and securely tightened.

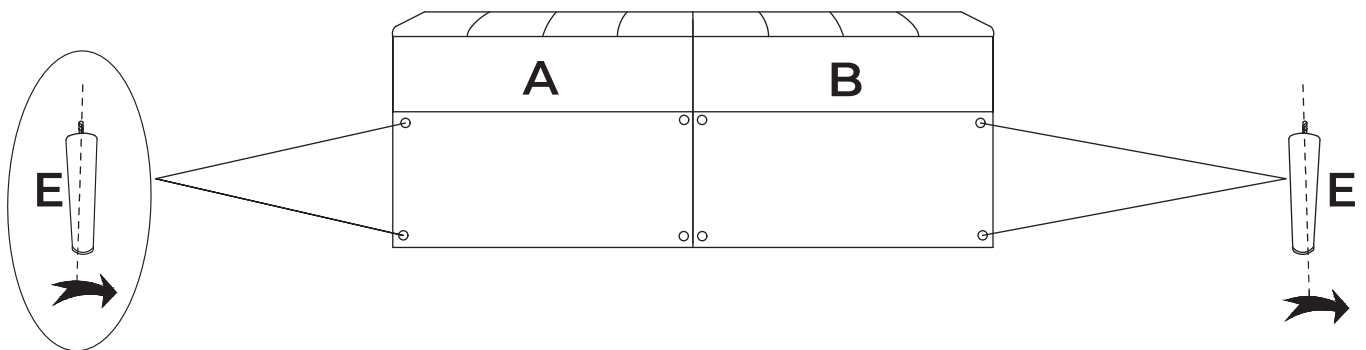

## Step 4

Align the inner metal components of C and D (armrests) with the side metal pins on modules A and B, and insert them vertically. Gently push downward to ensure the metal connectors are fully embedded. (no-screw installation).

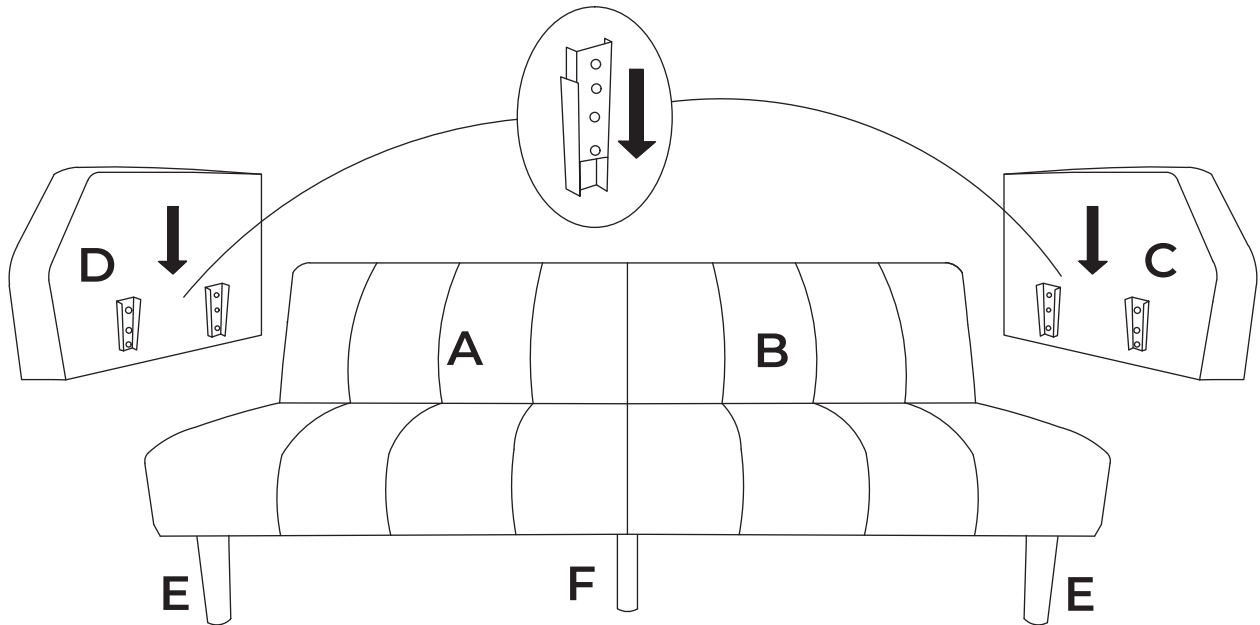

---

## Step 5

DONE!

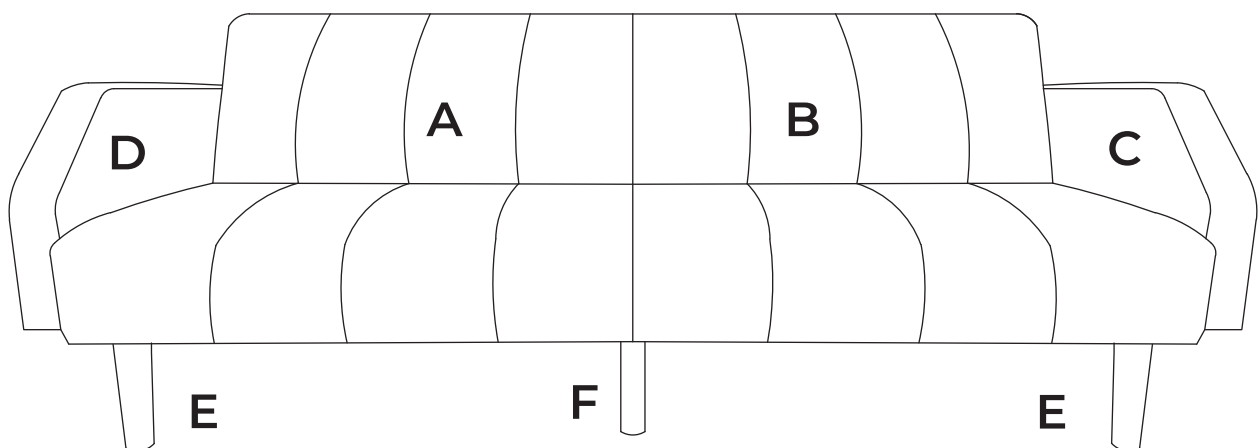

# DONE!



Weight Limit: 700 lb / 317 kg

## Care Instructions

1. The backrests of A and B each have 3 gears for independent adjustment. Gently push forward (listen for a sound) to change the gears. Push the backrest all the way forward to unlock and reset.
2. When cleaning the product, use a soft cloth to gently clean it or use professional cleaning supplies. Do not use chemical agents or abrasive cleaners to wipe the product.
3. During use, do not exceed the maximum weight-bearing capacity of the product. Exceeding this limit may cause damage to the product or pose a risk of personal injury.
4. For safety reasons, do not leave infants alone on the product to prevent unnecessary harm such as suffocation.
5. If you need to move the product, do so with two or more individuals and carefully relocate it to a new area. Additionally, this product can be disassembled and reassembled if needed.