

SAFETY INFORMATION

Please read and understand this entire manual before attempting to assemble, operate or install the product.

WARNING

- Turn off electricity at main fuse box (or circuit breaker box) before beginning installation by removing fuse (or switching off circuit breaker).
- Be careful not to damage or cut the wire insulation (covering) during fixture installation. Do not permit wires to contact any surface having a sharp edge. To do so may damage or cut the wire insulation, which could cause serious injury or death from electric shock.







CAUTION

• All electrical connections must be in agreement with local codes, ordinances or the national electric code (NEC). Contact your municipal building department to learn about your local codes, permits and/or inspections.

- Risk of fire – most dwellings built before 1985 have supply wire rated for 140°F/60°C. Consult a qualified electrician before installation.
- Do not connect this fixture to an electrical system that does not provide a means for equipment grounding. Never use a fixture in a two-wire system that is not grounded. If you are not sure your lighting system has a grounding means, do not attempt to install this fixture. Contact a qualified, licensed electrician for information with regards to proper grounding methods as required by the local electrical code in your area.
- If a dimmer control switch is used with this fixture, obtain professional advice to determine the correct type and electrical rating required.

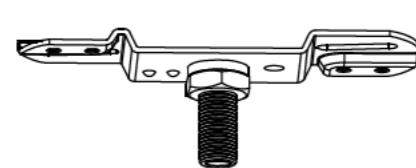
AC 120V 60Hz G9 SBLED 5×MAX 5W
OR XENON G9 5×MAX 25W
Product Dimensions: D15.75"×H81.5"

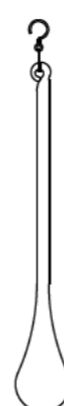
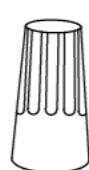
Part List and Hardware List

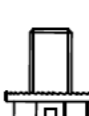
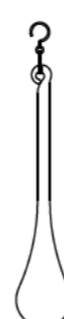
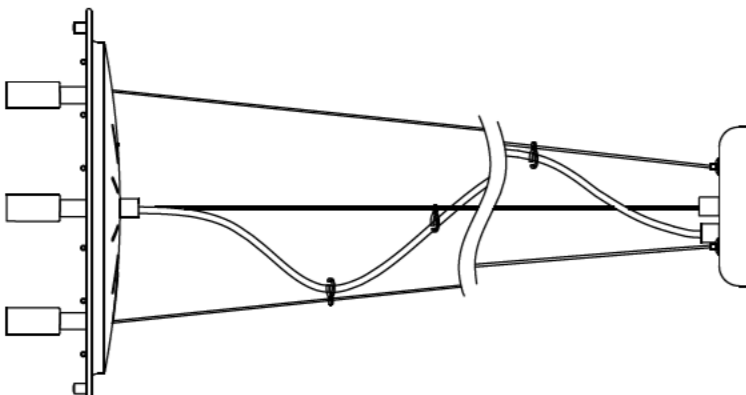
PIECE	DESCRIPTION	PICTURE	QUANTITY	PIECE	DESCRIPTION	PICTURE	QUANTITY
A	Glass shade		X1	F	Final		X1
B	Bracket		X1	G	G9 LED Bulb		X5
HW1	Phillips screw Hex bolt 8#-32N x 25 MM		X2	H	Crystal drop A		X4
C	P4 wire nut		X3	I	Crystal drop B		X8
D	Green screw		X1	J	Crystal drop C		X16
E	Lamp body		X1				

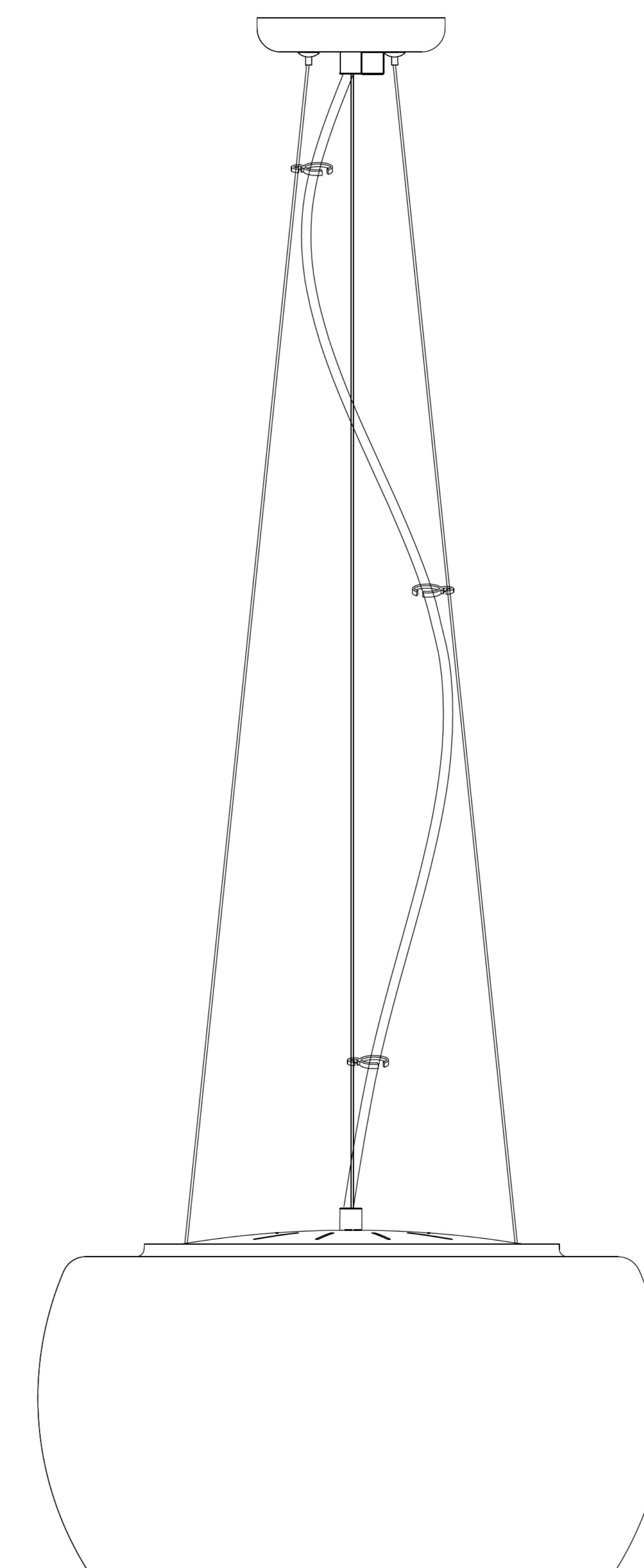

PREPARATION

Before beginning assembly of product, make sure all parts are present. Compare parts with package contents list and hardware contents list. If any part is missing or damaged, do not attempt to assemble the product.
Estimated Assembly Time: 20 minutes.

Carefully remove all lamp parts from the box, lay all parts on a flat surface. please see list of items included in box below.

1. Make sure the power supply is off before installation.
2. Fix the bracket(B) on the outlet box by phillips screw(HW1).
3. Install the glass shade(A) into the lampbody(E).
4. Make wire connections,with wire connectors(C),following the reference chart listed below.

Connect,Hot,Black or Red outlet Supply Wire to:	Connect,Neutral,White Outlet Supply Wire to:
Black	White
*Parallel Cord(round&smooth)	*Parallel Cord(square&ridged)
Clear,Brown,Gold or Black without Tracer(colored stripes)	Clear,Brwn,Gold or Black without Tracer(colored stripes)
Insulated Wire(not green)with copper metal conductor	Insulated Wire(not green)with Silver metal conductor

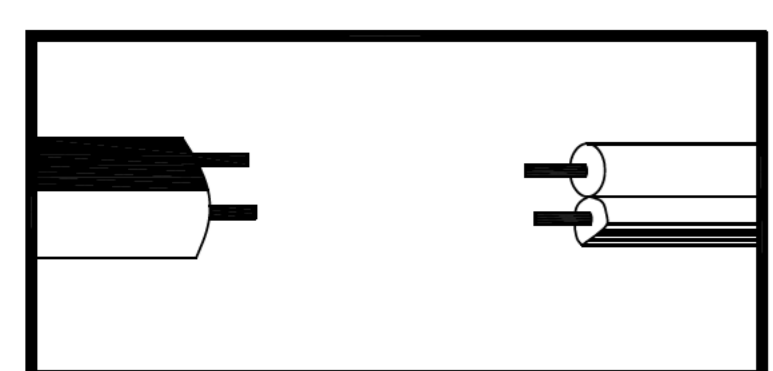

*Note: When parallel wire(SPTI&SPTII)is used. The neutral wire is square shaped and ridged and the hot wire will be round in shape and smooth.(See illustration on left)

Grounding Instructions: The ground wires are green color wire and bare copper wire.

- a) For installation in the United States: Wrap ground wire from outlet box around green ground screw on mounting bracket, no less than 2" from wire end. Tighten ground screw. If fixture is supplied with a ground wire, connect to outlet ground wire with a wire connector.
 - b) For installation in Canada: If fixture is supplied with ground wire, wrap ground wire around green grounding screw on mounting bracket. Tighten ground screw.2/3
5. Move the lamp body(E) to the bracket position, lock the lamp body with final(F) after align with the hole position.
 6. Install the G9 LED bulb(G) into the lampholder. Hang the crystal drop A(H), crystal drop B(I),crystal drop C(J) to the lampbody(E) according to the illustration.

PLEASE USE MAX 25 WATT TYPE G9 XENON (NOT TUNGSTEN HALOGEN) BULB OR MAX 5 WATT TYPE G9 SELF-BALLASTED LED BULB.

THERE ARE 5 X 4W LED BULBS IN THE BOX.

ENJOY YOUR LAMP

