

Download APP

1: Search "WBM Smart" from App store or Google play.

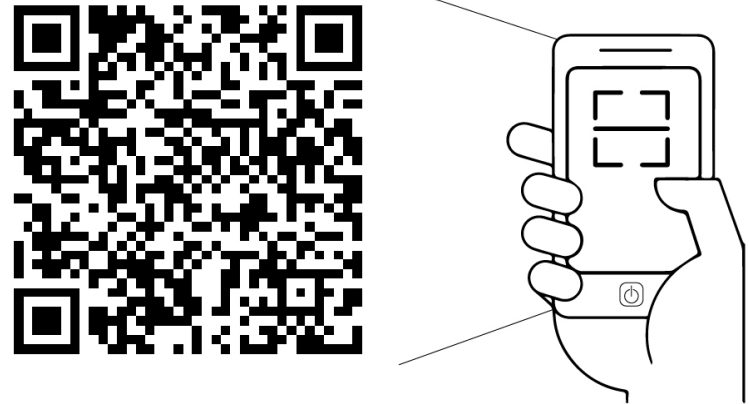

2: Scan the QR code from the label or user manual.



The APP is compatible with Android 4.0 and IOS 8.1 and higher version.



Log in / Register account number

Open the WBM Smart APP, sign up for a new account or log in with an existing account.

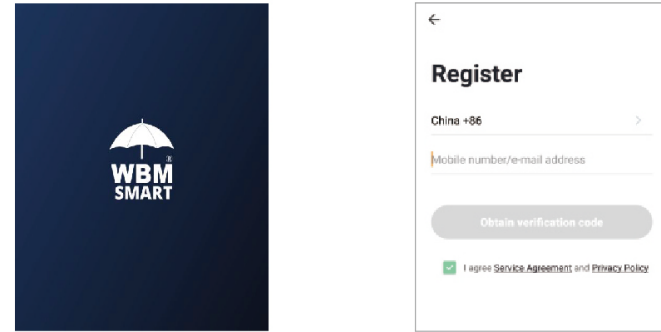

APP connection

1. Preparation: Turn on the LED strip and enter the home of APP while ensure the WIFI signal is good and stable.
2. LED strip will flashing when turn on the power supply. Add all devices on the APP and enter adding lighting device interface, match LED strips.

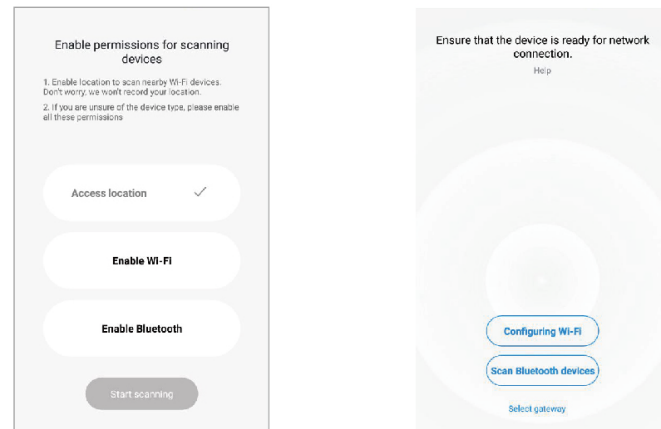

3. If the LED strip is not flashing when turn on the power supply, long press the Reset button for more than 5 seconds. While LED strip flashing, enter the APP adding lighting device interface, match LED strips.

4. Select the Wi-Fi connected to the smart device, input the WiFi password, and then click "OK" to wait for the matching to succeed. (Make sure smart devices share the same WiFi)

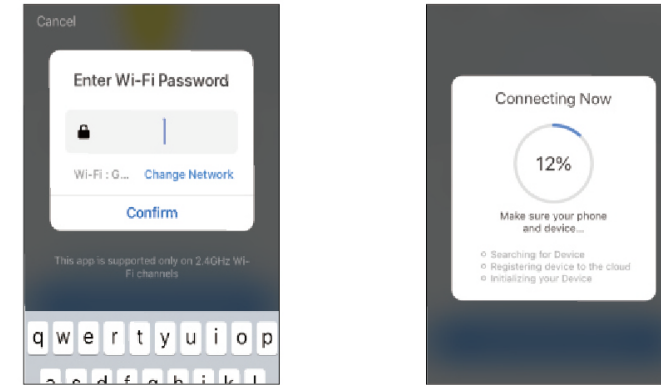

Note:

Click the interface to control it according to the specific mode of the specific LED strip.

The following is public function introduction.

Remote control: The LED strip can be controlled anywhere after the smart device is successfully connected.

Timer function: Set the timer to turn on and turn off the LED strip.

Intelligent scene: The system sets a variety of intelligent scenes, and different scenes correspond to different lighting atmospheres.

Group: Group control is available (only for the same type of product). Family room management Device Sharing: The device is shared with other user control devices in the home.

APP function introduction

Click the interface to control it according to the specific mode of the specific LED strip. The following is public function introduction.

- Remote control: The LED strip can be controlled anywhere after the smart device is successfully connected.
- Timer function: Set the timer to turn on and turn off the LED strip.
- Intelligent scene: The system sets a variety of intelligent scenes, and different scenes correspond to different lighting atmospheres.
- Group: Group control is available (only for the same type of product). Family room management.
- Device Sharing: The device is shared with other user control devices in the home.

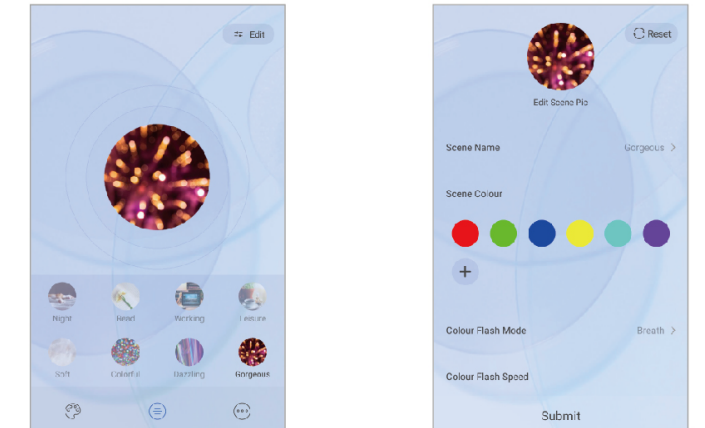

Third party control:







In the WBM Smart APP: Find more service in "Me" menu, click to enter "voice service" (Alexa/ Google Assistant) and other services, click on the service you need. Connect to the third-party service device according to the operation guide.



Wi-Fi Smart Strip User Manual



Features

-  WIFI connect, mobile phone APP control, Android and IOS support
-  Full range of W / W + WW / RGB / RGBW / RGBWW available
-  Voice and intelligent speaker control
-  5-100% stepless dimming
-  Timer switch
-  Remote controllable after connecting to internet

Parameters

Item.NO	Colour	Input Voltage	Power	Current
LP-03	RGB	12~24Vdc	Max.48W	2A*3CH Max.2A

Dimension

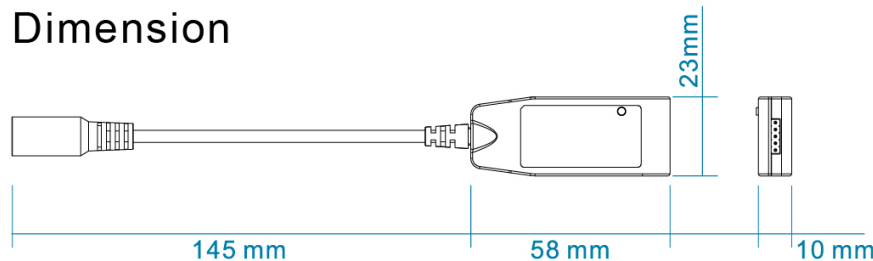

Wiring diagram

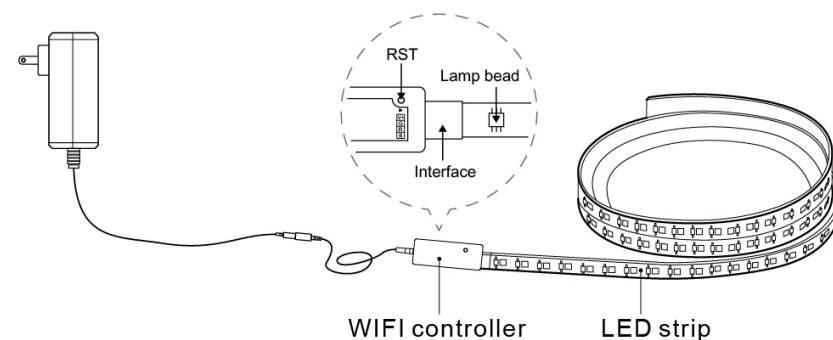

Installation instructions

- Use DC12/24V power supply.
- Install the WIFI controller correctly.
 - Use screw to fix it
 - Use 3M tape to fix it
- Please unfold the LED strip to avoid the overheat issues. Please connect the cables of LED strip with the right position on the controller. Test the APP to check if it can control the LED strip correctly. If everything goes well, just keep going.
- Check and ensure the power supply, WIFI controller and LED strip are connected correctly.

Attentions

- Do not put any metal around the WIFI controller, which could blocked WiFi signal
- Ensure power supply and controller are connected correctly.
- The power supply output voltage should be same as LED strip working voltage.
- Do not cover anything on the surface of power supply, WIFI controller and LED strip.
- Ensure the connection is correct before powering.

Product functions diagram

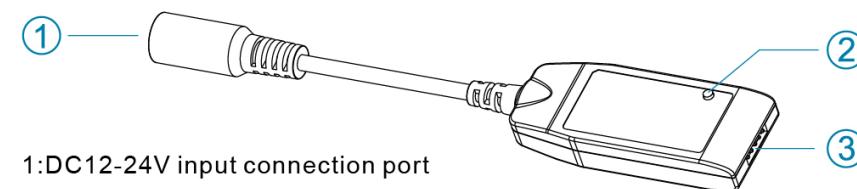

- DC12-24V input connection port
- Output connection port to connect to LED strip(2-6PIN female bracket/5PIN male PIN connector)
- Function button: Turn on.
Scene change mode. Scene changing mode
Double click twice quickly to turn off Long press over 5 seconds to reset use for network pairing.



Contact Us
54 HWY 12, Flemington
NJ 08822 USA 1-866-802-9366
www.wbminternational.com



BOOK MARK US