

EN:

**CAUTION:**

- \* Before using the chair, ensure that all screws are fully tightened.
- \* Retighten all screws every 6 months or as needed.

To remove odor, air the chair outdoors in shade for 1-2 days.

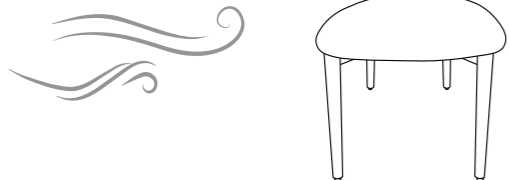

Periodically retighten all screws. Do not use an electric screwdriver.



ES:

**PRECAUCIÓN:**

- \* Antes de usar la silla, asegúrese de que todos los tornillos estén bien apretados.
- \* Vuelva a apretar todos los tornillos cada 6 meses o cuando sea necesario.

Para eliminar el olor, aeree la silla al aire libre, a la sombra, durante 1-2 días.

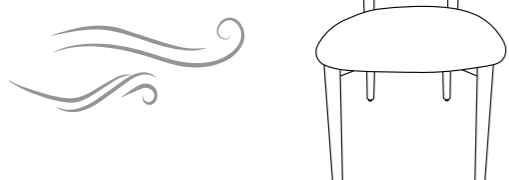

Vuelva a apretar periódicamente todos los tornillos. No utilice un atornillador eléctrico.



FR :

**ATTENTION :**

- \* Avant d'utiliser la chaise, assurez-vous que tous les vis sont complètement serrés.
- \* Resserrez toutes les vis tous les 6 mois ou selon les besoins.



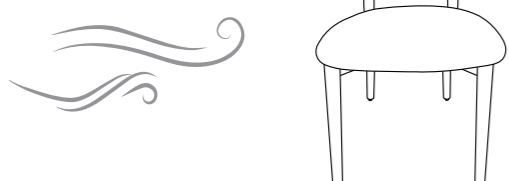

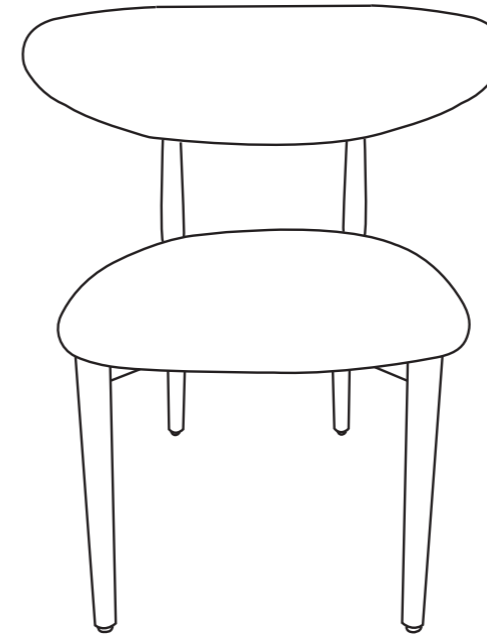

Pour éliminer les odeurs, aérez la chaise à l'extérieur à l'ombre pendant 1 à 2 jours.

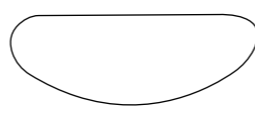
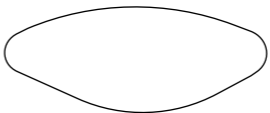
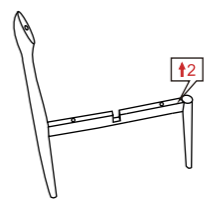
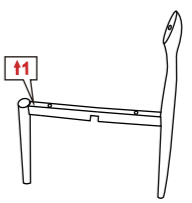
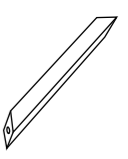

Resserrez périodiquement toutes les vis. N'utilisez pas de tournevis électrique.





**INSTRUCTION MANUAL**  
**MANUAL DE INSTRUCCIONES**  
**MANUEL D'INSTRUCTIONS**

<b>A</b> x1	<b>B</b> x1	<b>C</b> x1	<b>D</b> x1	<b>E</b> x1
				
<b>1</b> x4	<b>2</b> x2	<b>3</b> x2	<b>4</b> x8	<b>5</b> x8
				
M6*60mm	M6*35mm	M6*40mm	M6*14mm	
<b>6</b> x1				
				

**Safety Information / Información de seguridad / Informations Relatives à la Sécurité**





EN:  : Partially tighten the screws.

 : Fully tighten the screws.

ES:  : Apriete parcialmente los tornillos.

 : Apriete completamente los tornillos.

FR:  : Serrez d'abord les vis partiellement.

 : Serrez les vis complètement.

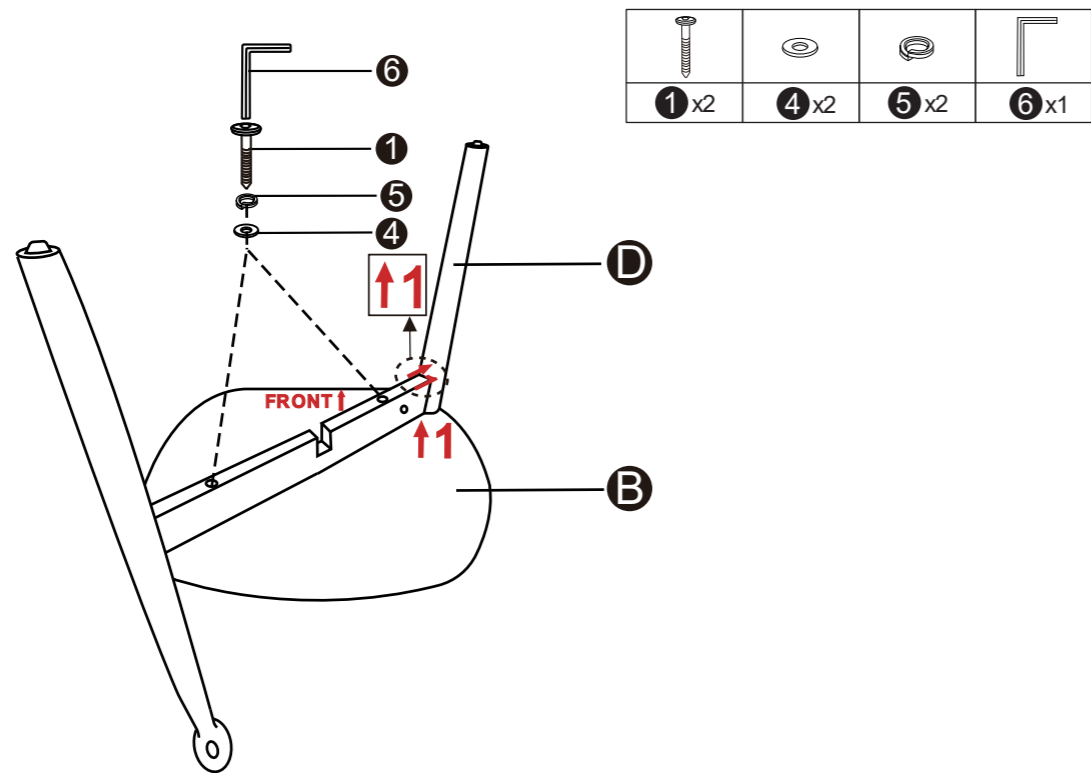
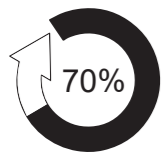

1

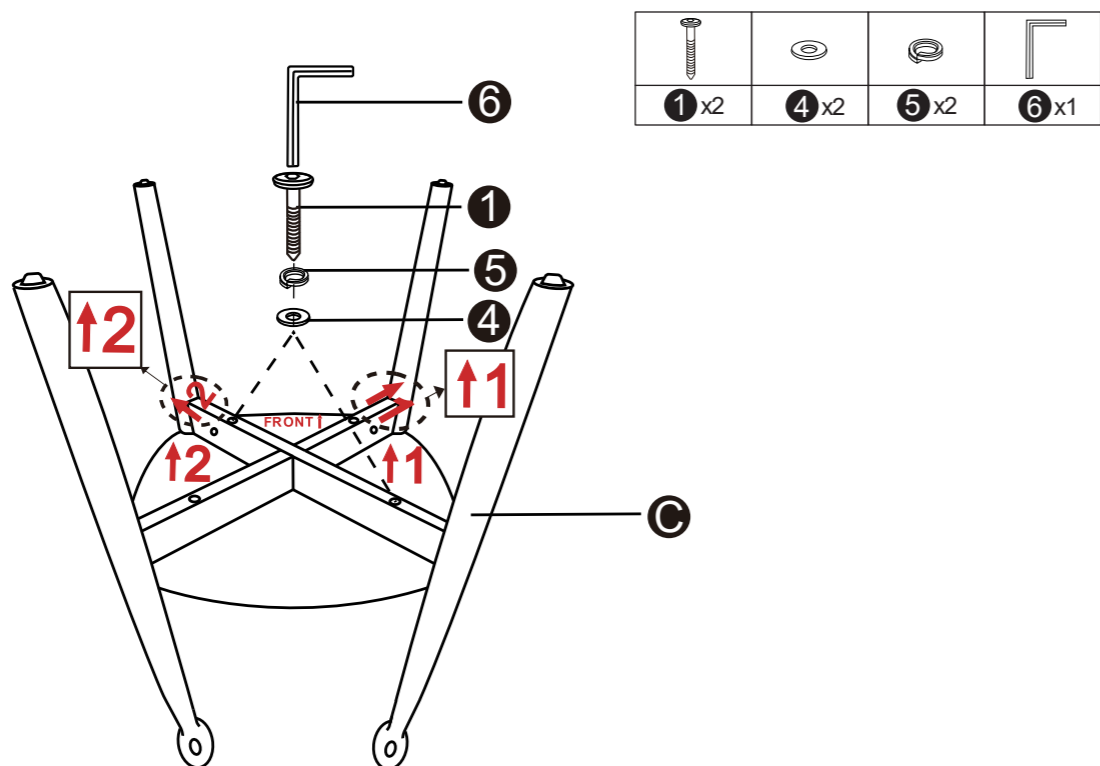
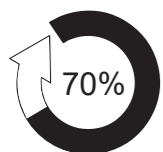

2

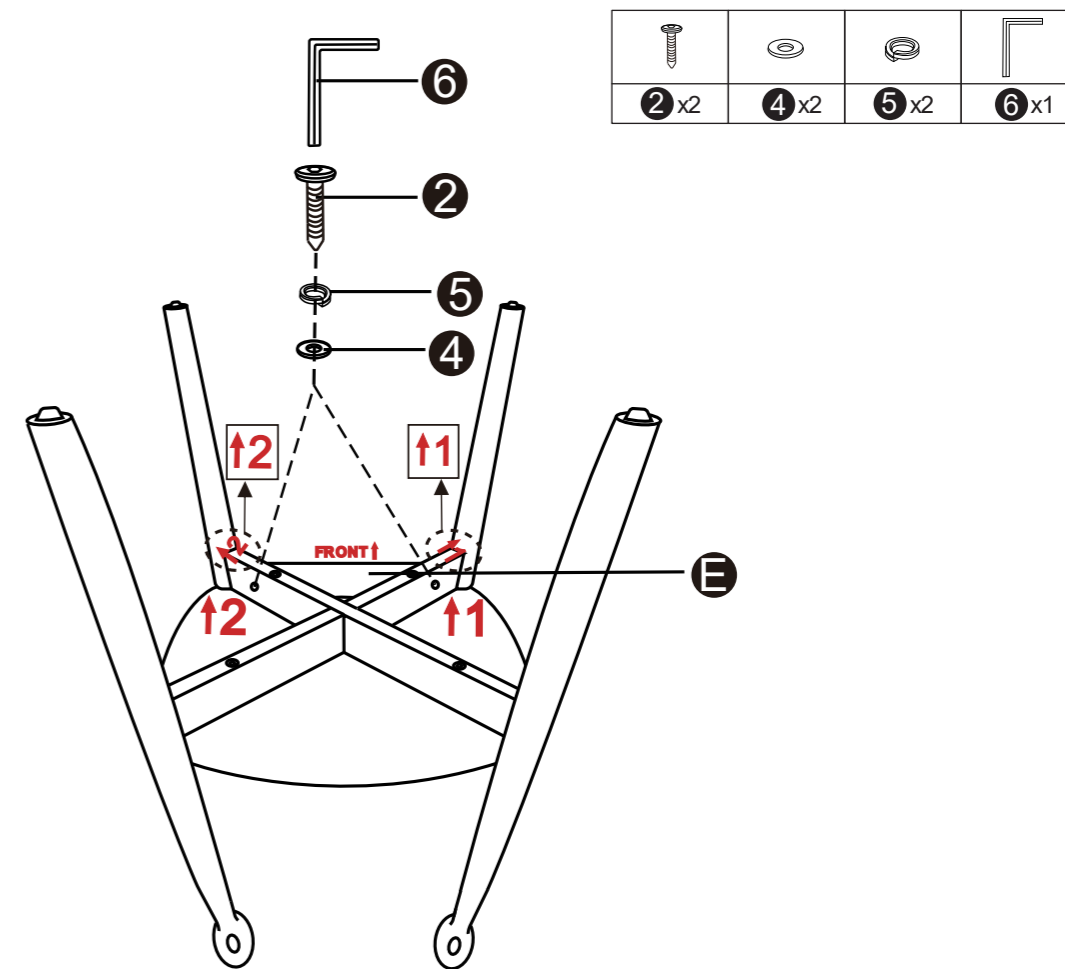
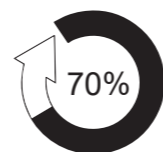

3

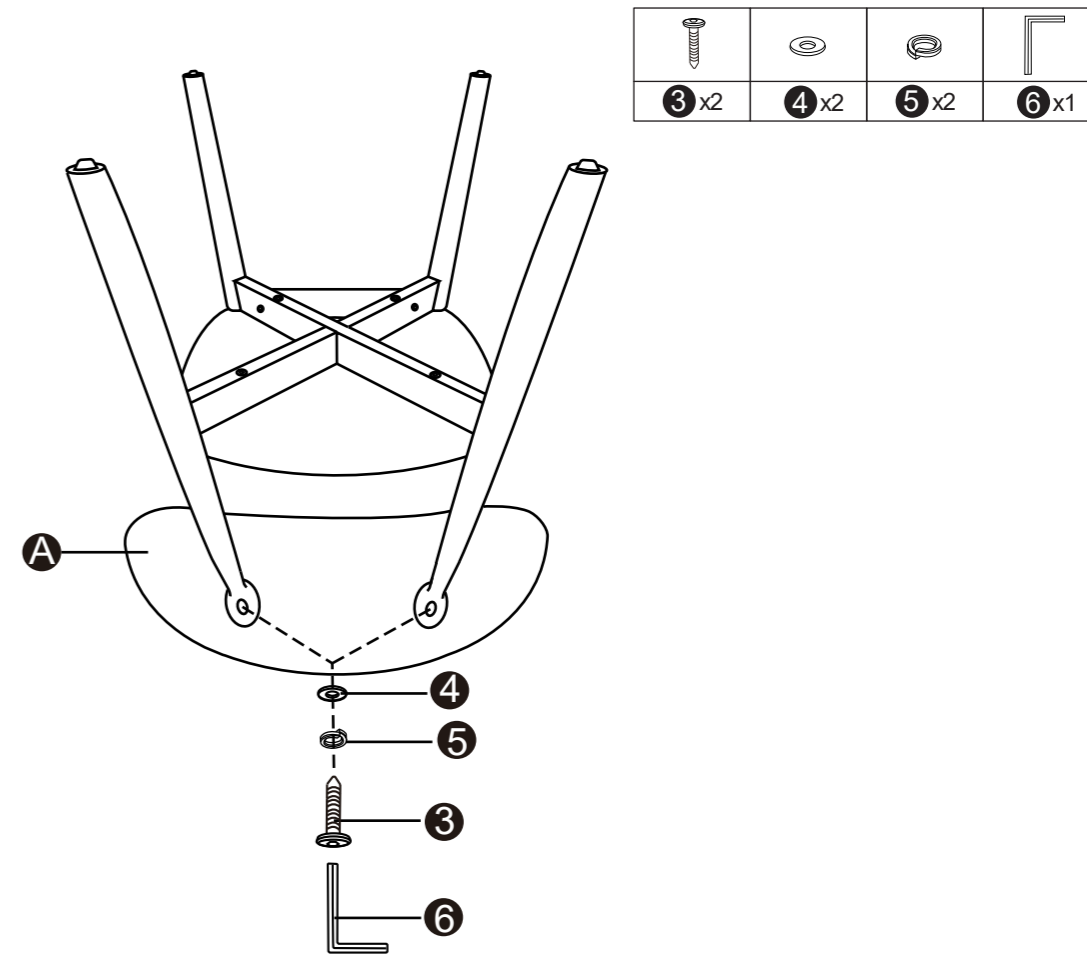

4

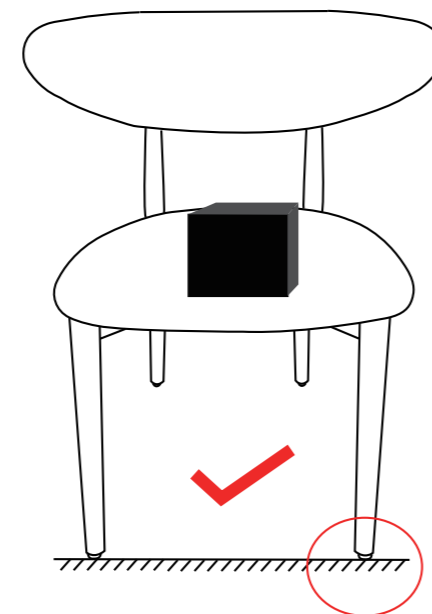
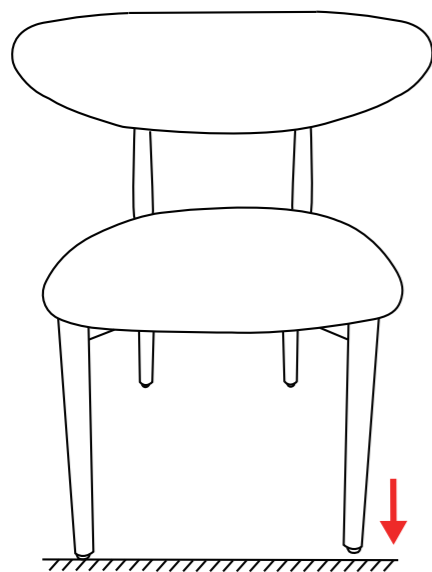
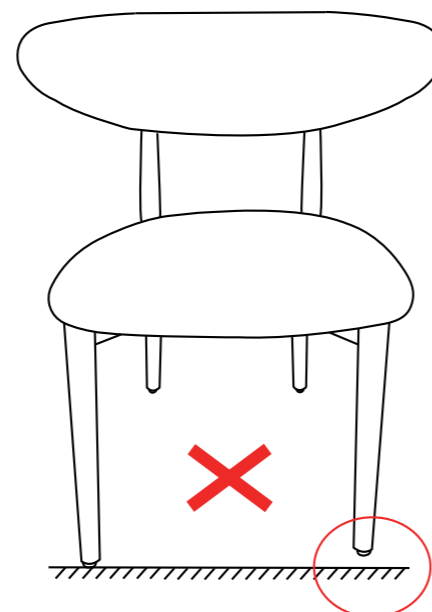
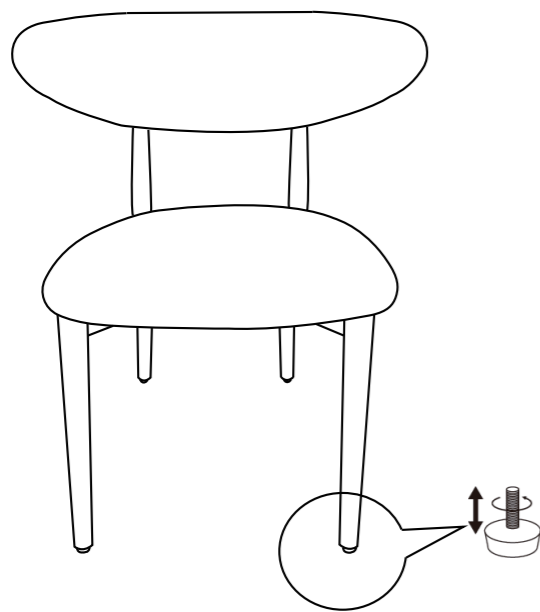

EN: Place an appropriate load on the chair and adjust the feet until it is level and stable.

ES: Coloque una carga adecuada en la silla y ajuste las patas hasta que la silla esté nivelada y estable.

FR: Appliquez une charge appropriée sur la chaise et ajustez les pieds jusqu'à ce qu'elle soit stable et de niveau.

5

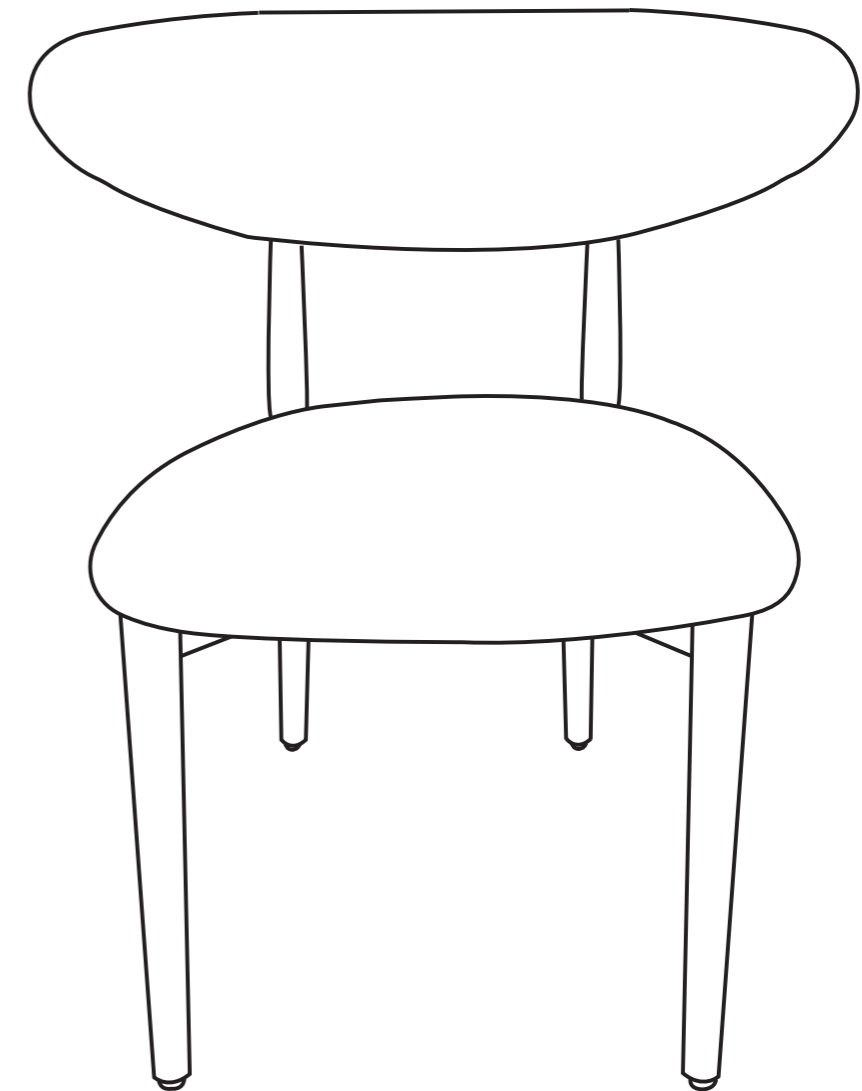

EN: After all parts are in place and the chair is leveled, tighten all screws.

ES: Después de que todas las piezas estén colocadas y la silla esté nivelada, apriete todos los tornillos.

FR: Une fois toutes les pièces en place et la chaise mise à niveau, serrez toutes les vis.

6