

CHAIRMAN-N

ASSEMBLY

INSTRUCTION

Contents

- Instructions
- User Manual
- Cautions

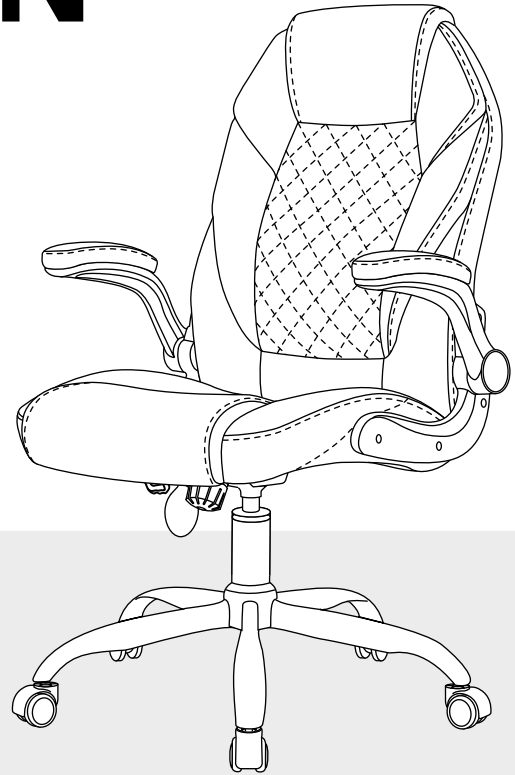

※Please make sure all the parts are included.

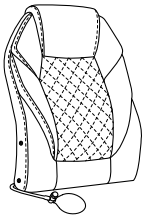

BACK X1



SEAT X1

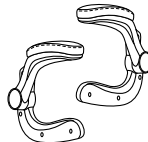

ARMREST X2

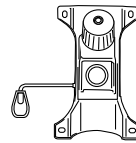

CONTROL MECHANISM X1



WHEEL X5

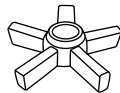

CENTRAL BASE X1

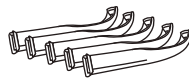

BASE LEG X5



GAS LIFT CYLINDER X1

M6*25mm



(A) X10
(CONTROL, ARMREST)

M6*20mm



(B) X2
(CONTROL)

M6*12mm



(C) X10
(BASE)



(D) X8
(BOLT CAP)



(E) X1
(ALLEN KEY)

⚠ NOTICE

Do not tighten the bolts all the way before each bolt is in place per step.

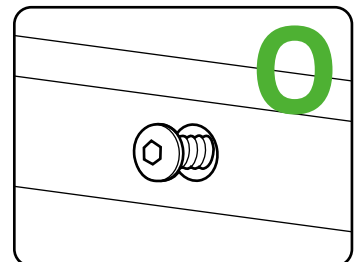
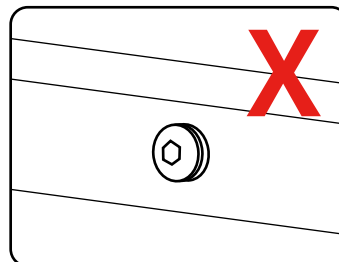

• Instructions

STEP 1. BOTTOM

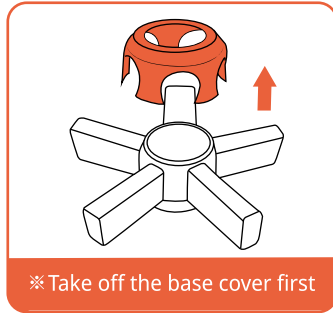
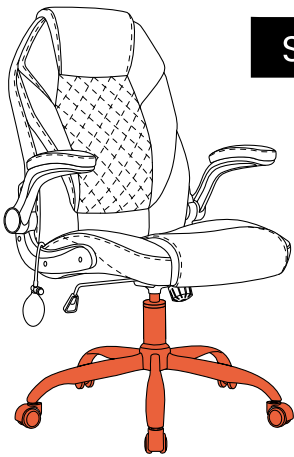

1

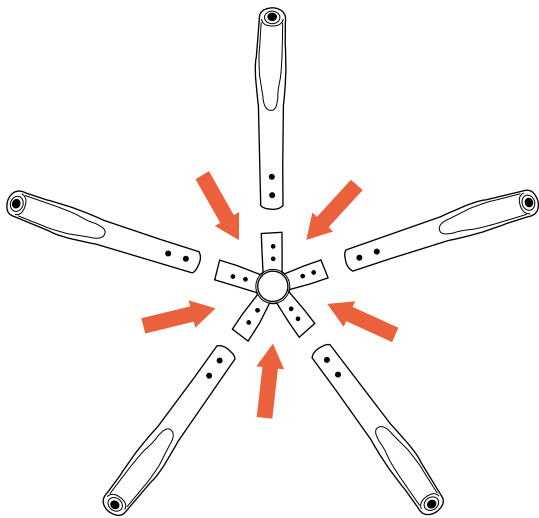

Insert the base legs into the central base so that the bolt holes are aligned and facing up.

3

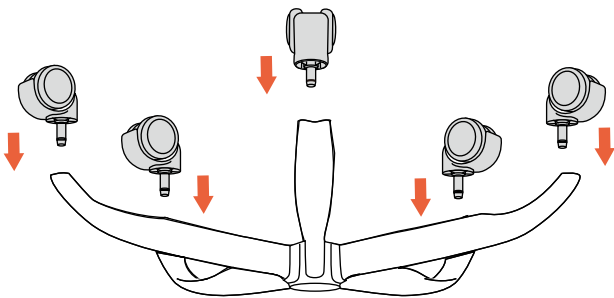

Insert each **wheel** into the **base leg** while the base is still upside down.

2

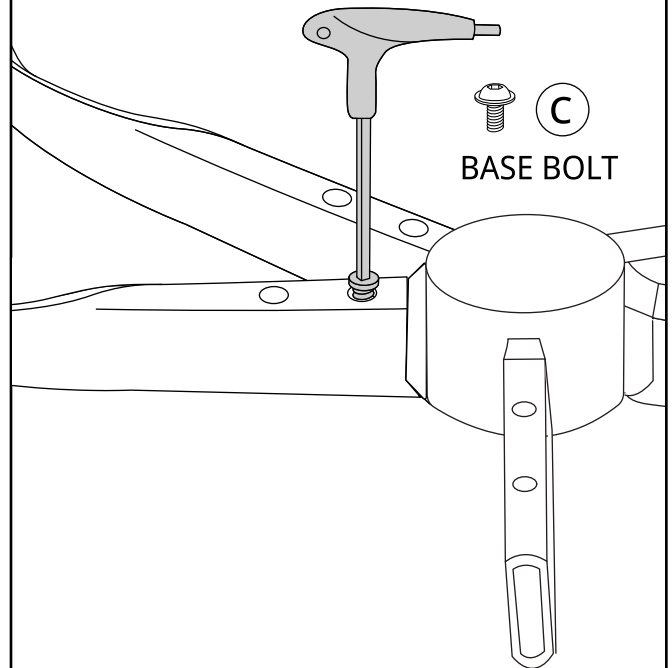

Secure with **bolts**.
Make sure to fully tighten all 10 bolts.

4

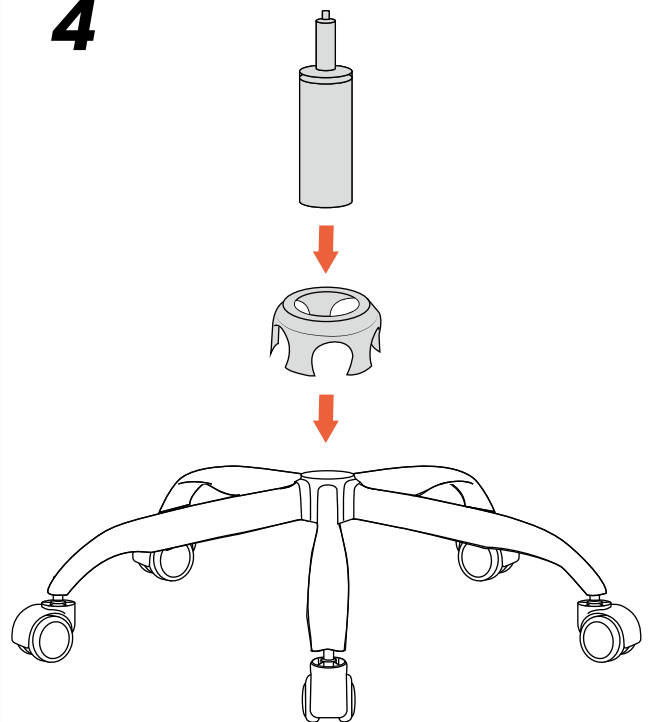

Turn the base over, and place the plastic cover back on the base.

• Instructions



STEP 2. TOP

5

FRONT

FRONT

A
CONTROL BOLT

B
CONTROL BOLT

Order of bolts for better durability.

1 → 2 → 3 → 4

Put control mechanism at the bottom of the seat find the front sticker and tighten the bolts.

6

Place the assembled seat onto the base and secure it.

7

A
ARMREST BOLT

Line up the armrest to the seat and loosely tighten with two bolts. Repeat on the other side.

8



A

ARMREST BOLT

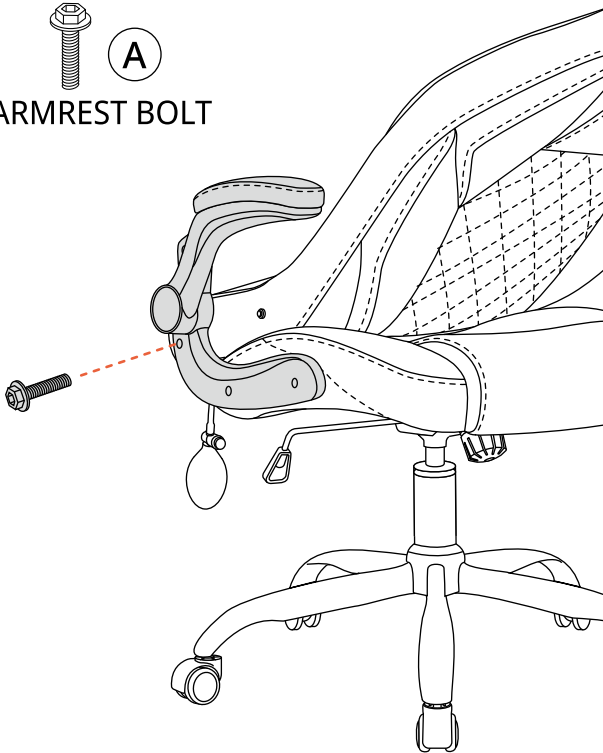

Align the armrest with the backrest and loosely tighten one bolt. Repeat on the other side.

9



A

ARMREST BOLT

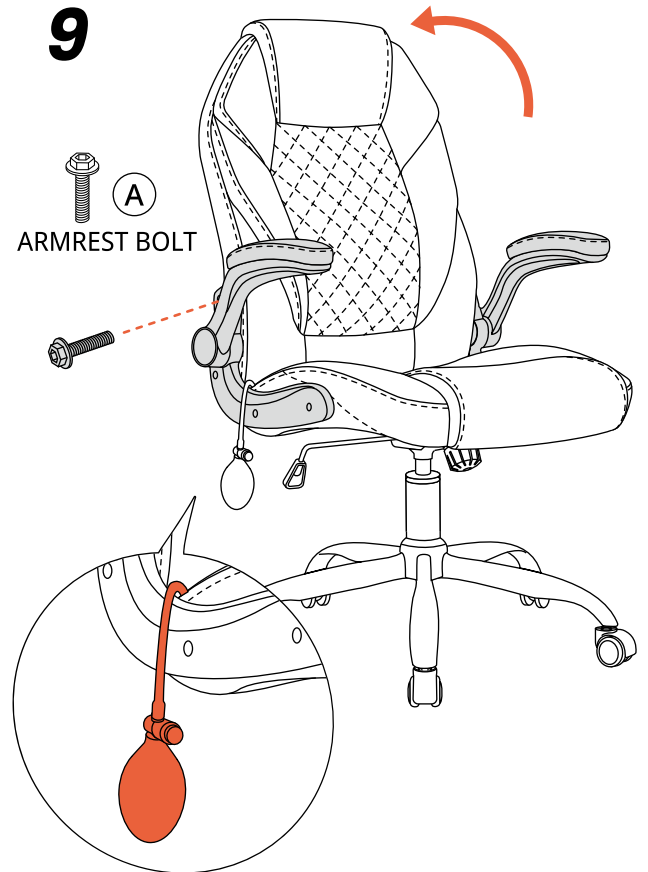

Raise the backrest, move the lumbar air pump forward, and tighten the bolts to the armrest.

10



DONE!

Optional insert

11

Bolt cap of your preference

D BOLT CAP

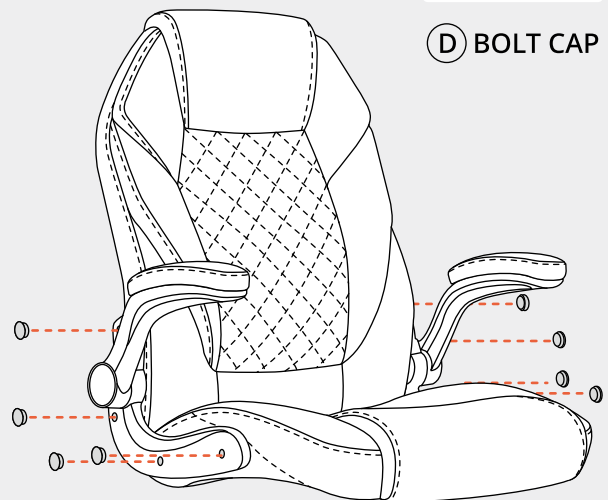

• User Manual

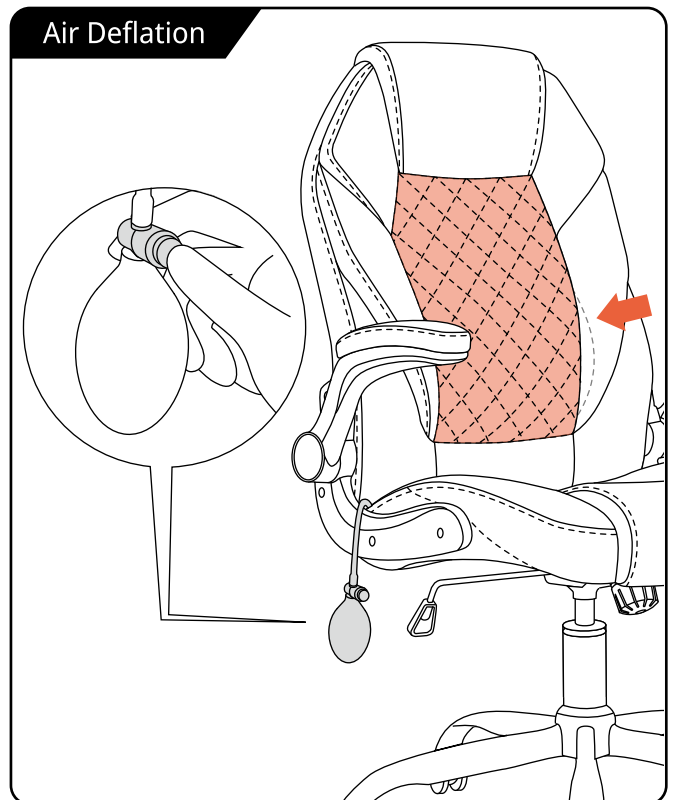
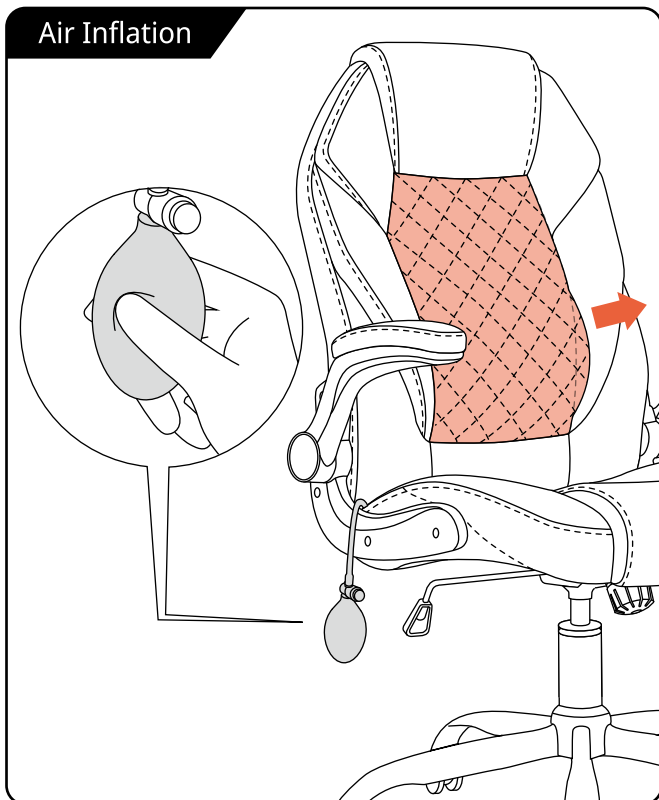
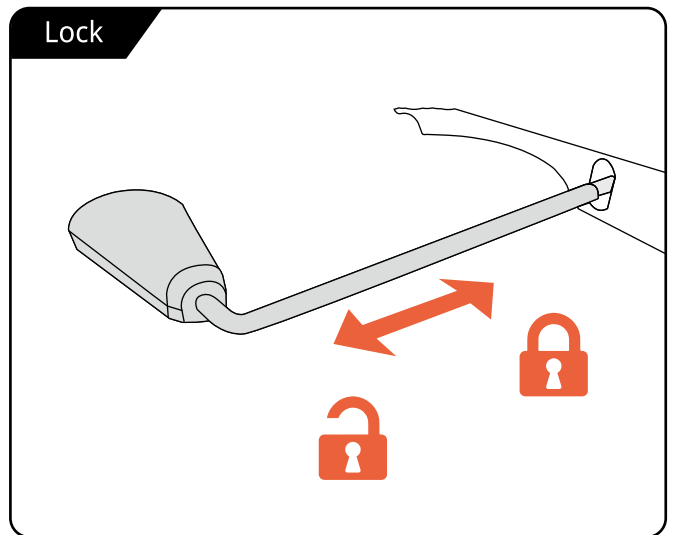
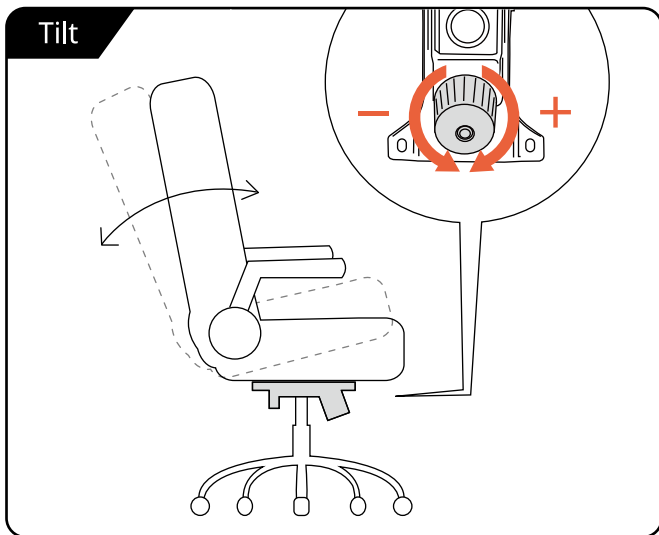
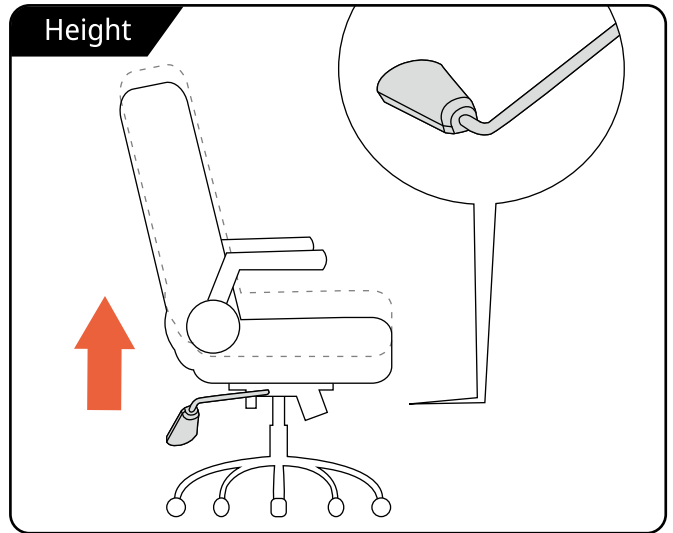
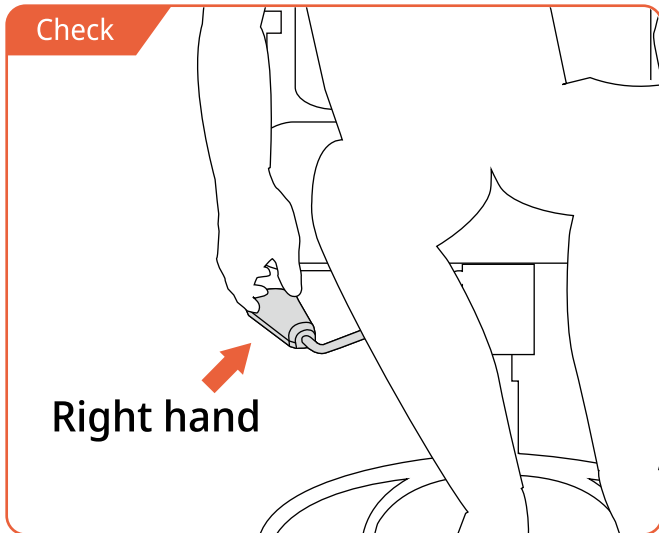



IMPORTANT SAFETY INSTRUCTIONS



Read these instructions carefully and retain them for future use. If this product is passed to a third party, then these instructions must be included.

1. Assembly

- For additional illustrated assembly steps, refer to the end of the written instructions.

2. Before First Use

- Suffocation Hazard: Packaging and small parts (screws, bolts, fasteners) may cause suffocation. Keep them away from children and pets, and secure all parts tightly during assembly.
- Children's Safety: Never leave children unattended with the chair. Teach children not to play with the chair, as it is not a toy. Climbing on the chair or playing with its moving parts can lead to falls or injuries. Additionally, ensure the chair is adjusted to a safe and appropriate height for children's use to prevent their feet from dangling, which can cause discomfort or pressure.
- Be mindful of pets around your chair. Chewing or clawing may damage the chair or create small parts that cause injury or health issues. Use protective covers or deterrents if your pets tend to chew furniture.
- Remove all the packing materials.
- Review all components before assembly. Check the product for transport damages.

3. Safety Instructions

When using the product, basic safety precautions should always be followed to reduce the risk of injury including the following:

- This product must be assembled by an adult.
- Wearing gloves during assembly is highly recommended.
- Keep children and pets away while assembling the product.
- Do not let children climb on or play with the product.
- Always use the product on a firm, level ground.
- Do not use this product if any parts are missing, damaged, or worn.
- To avoid scratching the floor, assemble the product on a soft surface, such as a carpet.
- Do not over-tighten the fasteners.
- Regularly examine the product for wear and tear. Stop using the product at the first sign of damage or if parts become detached.
- Do not use power tools to assemble the product. Power tools may strip or damage the parts.
- Do not stand on the seat or sit on the armrests.
- Keep all sharp objects away from the upholstery.
- Do not hang anything on the product.
- Always keep the entire base of the chair in contact with the floor.
- If the chair is wobbly, tilted, or unstable do not continue using the chair until it is fixed or replaced.
- Do not lean back in the chair by either lifting the front legs off the ground or forcing the back of the chair into a horizontal position.
- Do not lean too far forward in the chair or sit too far forward on the edge of the seat because this can result in an unexpected tip-over.
- Ensure all wheels are securely installed. Do not sit on the chair if the wheels are not fully installed.
- Ensure the detachable leg is fully and securely installed before use. Do not sit on the chair if the detachable leg is not completely installed in the socket.
- Overloading the chair may result in breakage or injury.