

Installation Instructions

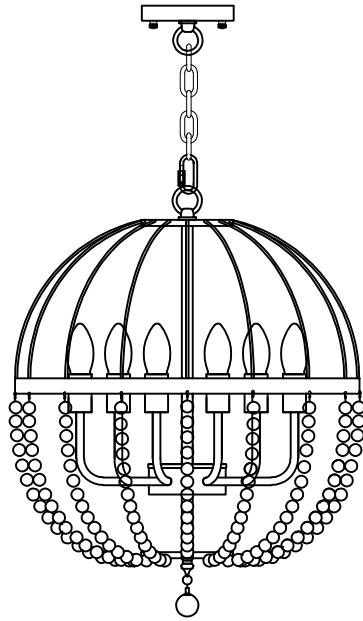

6x Max 60W Candelabra Base

Safety Information

READ AND SAVE THESE INSTRUCTIONS

1. For your protection and safety, carefully read and understand the information provided in this manual completely before attempting to assemble, install, or operate this product. Failure to do so could lead to electrical shock, fire, or other injuries that could be hazardous or even fatal.
2. Before touching any wire, use a voltage tester to make sure it not live.
3. When replacing fuses, turn off the main power first. Make sure your hands and feet are dry, and place one hand behind your back to prevent electricity from making a complete circuit through your chest. Touch the plug fuse only by its insulated rim. Remove cartridge fuses with a fuse puller
4. Use tools with insulated handles and ladders made of wood or fiberglass.
5. To protect children, place a safety cover over any unused outlets.



DANGER: Before starting installation of this fixture or removal of a previous fixture, disconnect the power by turning off the circuit breaker, removing the fuse at the fuse box, or tripping the breaker that controls that circuit. Tape a sign to the panel warning others to leave the circuit alone while you work.



CAUTION: CONSULT A QUALIFIED ELECTRICIAN IF YOU HAVE ANY ELECTRICAL QUESTIONS. If you have any non-electrical questions about this fixture please contact our customer service via the distributor where you purchased this product from. We will be more than happy to assist.

Pre-Installation

PLANNING INSTALLATION

Read all instructions before installing.

To avoid damaging this product, place it on a soft, non-abrasive surface, such as carpet or cardboard.

TOOLS REQUIRED (NOT INCLUDED)



Phillips
Screwdriver



Wire
Stripper

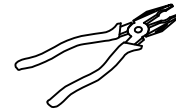

Pliers



Safety
Goggles



Electrical
Tape

HARDWARE INCLUDED

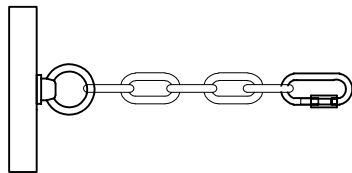

Canopy and hanging chain 1PCS



hanging board 1PCS



3PCS



3PCS



cap nut 2PCS



3PCS



Wooden bead string 16PCS

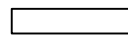

3.15in hanging tube 1PCS



2PCS



1PCS



Closed suspension ring 1PCS



2PCS

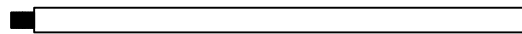

12.59in hanging tube 1PCS



Small iron ring 1PCS

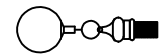

Wooden pendant 1PCS

Assembly Instructions

Assembly of this fixture will be accomplished by first determining the length of stem or chain required, attaching the mounting plate to the junction box, making all necessary electrical connections, hanging the fixture from the ceiling and then installing the fixture

Safety Warning

Read wiring and grounding instruction and any additional directions. Turn power supply off during installation. If new wiring is required, consult a qualified electrician or local authorities for code requirements.

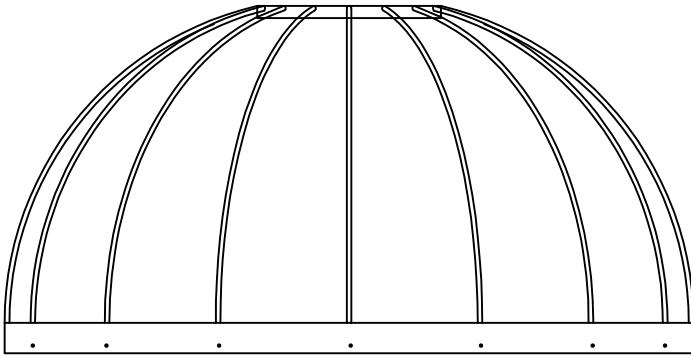

Fixture body 1PCS

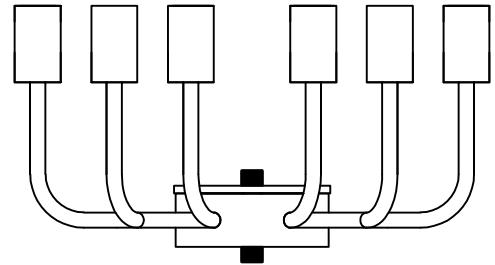

Lamp head assembly 1PCS

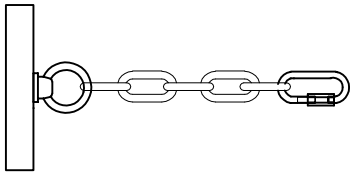

Canopy and hanging chain 1PCS



hanging board 1PCS



3PCS



3PCS



cap nut 2PCS



3PCS



Wooden bead string 16PCS

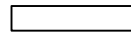

3.15in hanging tube 1PCS



2PCS



1PCS



Closed suspension ring 1PCS



2PCS

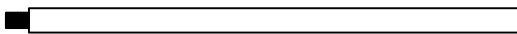

12.59in hanging tube 1PCS



Small iron ring 1PCS

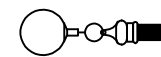

Wooden pendant 1PCS

1

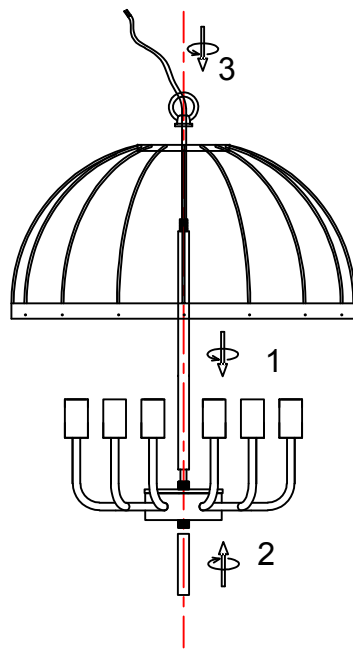

1. Install the 12.59-in suspension tube above the lamp head assembly
2. Install the 3.15-in suspension tube under the lamp head assembly
3. The suspension tube passes through the main body of the lamp and is fixed by tightening the closed suspension ring

2

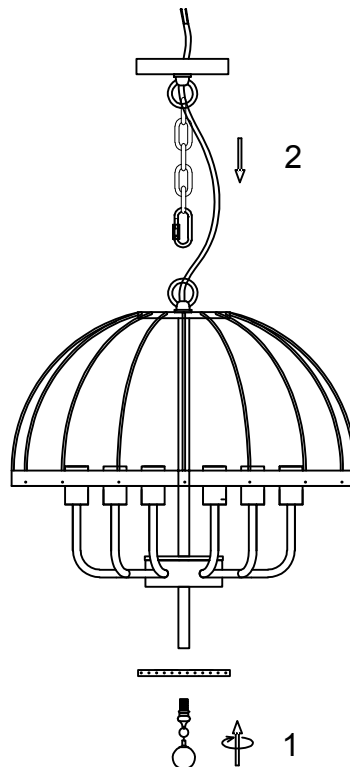

1. The wooden pendant passes through a small iron ring and is mounted on a hanging pipe
2. Loosen the nut on the suspension chain and thread it through the hanging ring on the lamp body before tightening it

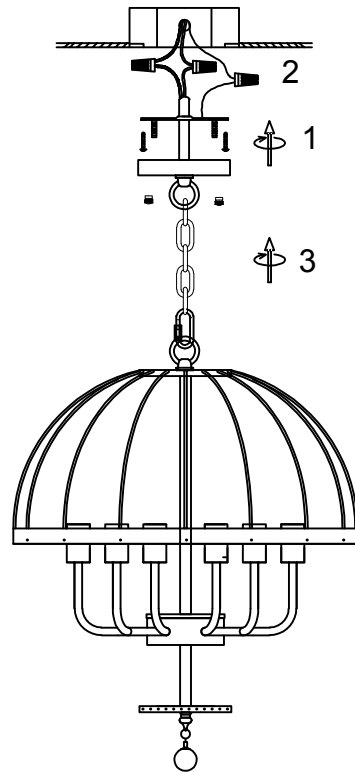

1. Install the hanging board on the ceiling junction box
2. Connect the wires to the home circuit and distinguish between positive and negative
3. Install the light fixture onto the suspension board and tighten it with a cap nut

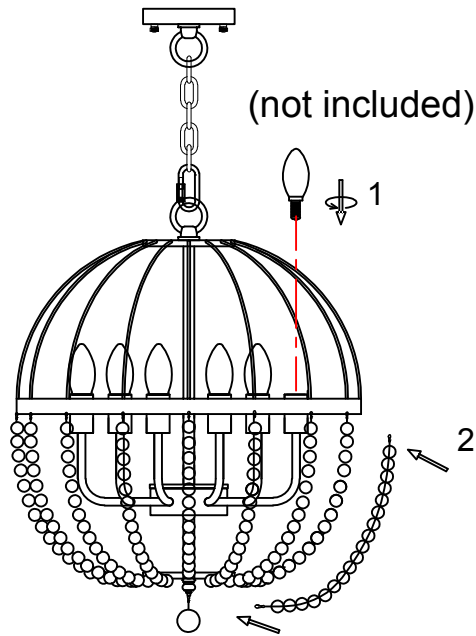

1. Twist the light bulb onto the lamp head
2. One end of the wooden bead string is hung on the main body of the lamp, and the other end is hung on a small iron ring

Please read carefully before installation!!!

Note : Please make sure that the electricity is powered off during installation !

Only a professional electrician should install this kind of product !

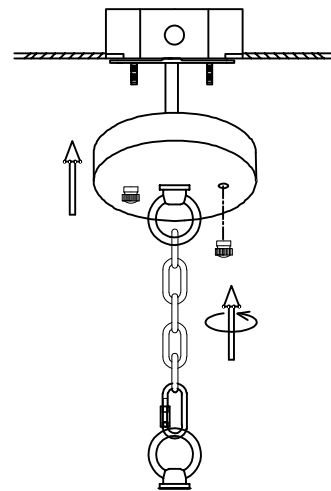
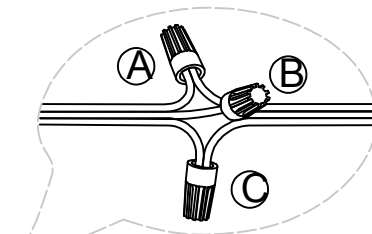
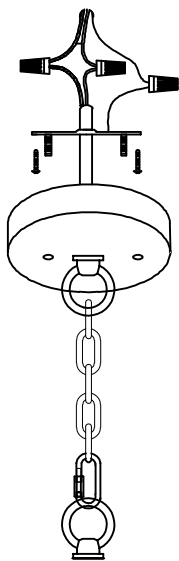
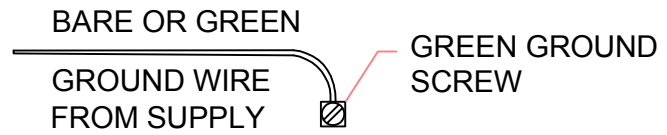
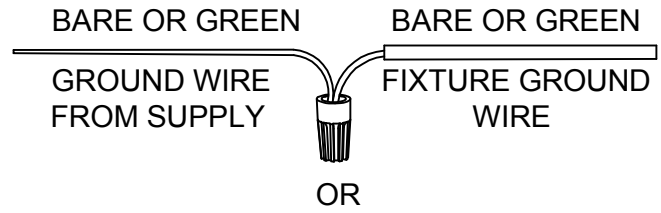
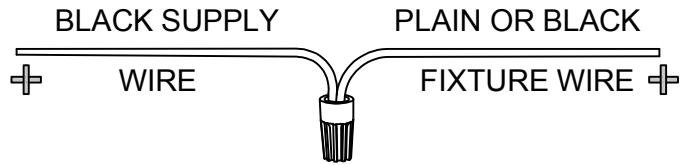
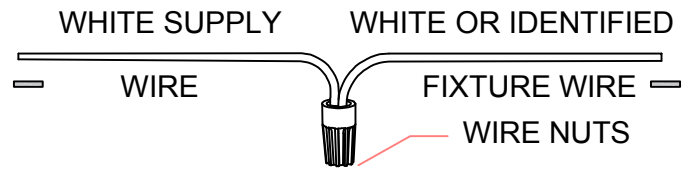
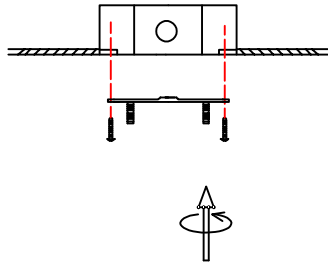

Thank you for choosing our product! If you have any questions about the installation of the lighting fixtures , please use the corresponding application on your smartphone to scan the QR code on the right and watch the installation video.

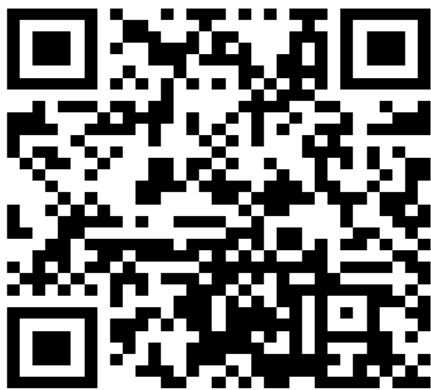

E12 SocketMax .
60W Bulbs (not
included)

MH-CH020315B

Warranty

ONE (1) YEAR WARRANTY

WHAT IS COVERED

The manufacturer warrants this fixture to be free from defects in materials and workmanship for a period of one (1) year from date of purchase. The warranty applies only to the original consumer purchaser and only to products used in normal use and service. If this product is found to be defective, the manufacturer's only obligation, and your exclusive remedy, is the repair or replacement of the product at the manufacturer's discretion, provided that the product has not been damaged through misuse, abuse, accident, modifications, alteration, way not in accordance with the instructions supplied with the product. This warranty shall not apply to a failure of the product as a result of an accident, misuse, abuse, negligence, alteration, faulty installation, or any other failure not relating to faulty material or workmanship. This warranty shall not apply to the finish on any portion of the product, such as surface and/or weathering, as this is considered normal wear and tear.

WHAT IS NOT COVERED

The manufacturer does not warrant and specifically disclaims any warranty, whether expressed or implied, of fitness for a particular purpose, other than the warranty contained herein. The manufacturer specifically disclaims any liability and shall not be liable for any consequential or incidental loss or damage, including but not limited to any labor/expense costs involved in the replacement or repair of said product.