

Features

- Two Lever handles offer separate control of hot and cold water
- 8-1/4" (210 mm) spout reach
- 10.0 gpm (37.9 lpm) maximum flow rate at 45 psi (3.1 bar)
- Coordinates with other products in the Parallel collection

Material

- Premium metal construction for durability and reliability
- KOHLER finishes resist corrosion and tarnishing

Installation

- Three-hole
- Deck-mount

Recommended Products/Accessories

- K-23726 Drain treatment
- K-21897 Double toilet paper holder
- K-23524 18" towel bar
- K-23525 24" towel bar
- K-23526 Towel arm
- K-23527 Vertical toilet paper holder
- K-23528 Pivoting toilet paper holder
- K-23529 Robe hook



ADA CSA B651 OBC

Codes/Standards









ASME A112.18.1/CSA B125.1
ADA
ICC/ANSI A117.1
CSA B651
OBC

KOHLER® Faucet Lifetime Limited Warranty

See website for detailed warranty information.

Available Colors/Finishes

Color tiles intended for reference only.

Color	Code	Description
	CP	Polished Chrome
	SN	Vibrant® Polished Nickel
	AF	Vibrant® French Gold
	BN	Vibrant® Brushed Nickel
	BV	Vibrant® Brushed Bronze
	BL	Matte Black
	2MB	Vibrant® Brushed Moderne Brass
	TT	Vibrant Titanium

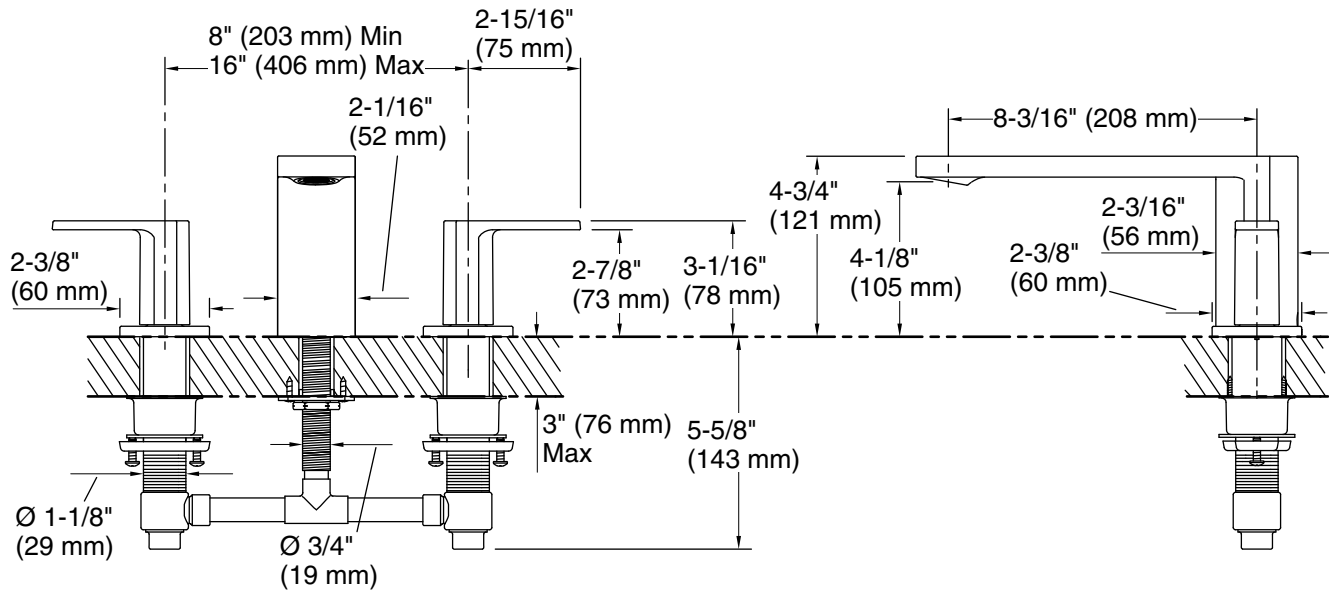

Technical Information

All product dimensions are nominal.

Faucet flow rate: 10 gal/min (37.9 l/min)

Drain with overflow: Yes

Spout:

Spout reach: 8-1/4" (209 mm)

Notes

Install this product according to the installation instructions.

ADA, OBC, CSA B651 compliant when installed to the specific requirements of these regulations.