

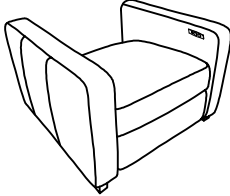

Assembly Instruction

Power Reclining Chair With USB Port

Note: Do not use power tools for assembly. Power tools increase the risk of over tightening which lead to splitting or cracking the wood.

Component list

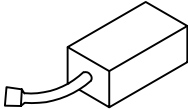
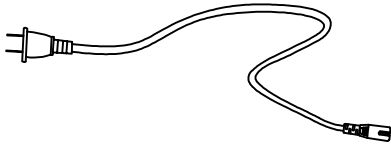
No	Drawing	Qty	Description
A		1	Seat
B		1	Backrest
C		1	Adaptor
D		1	Plug

THE PARTS ARE LOCATED INSIDE THE BOX AS BELOW:

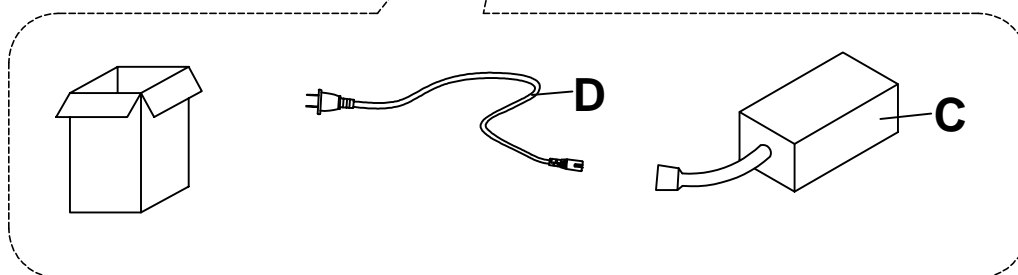
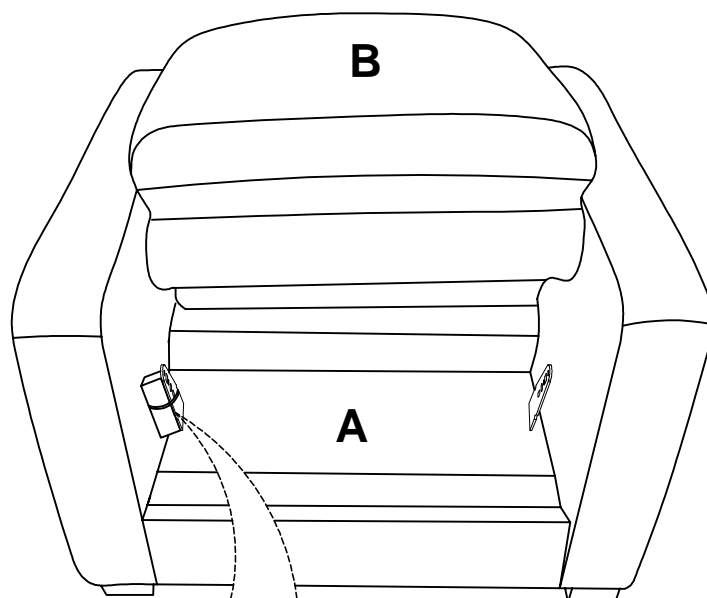
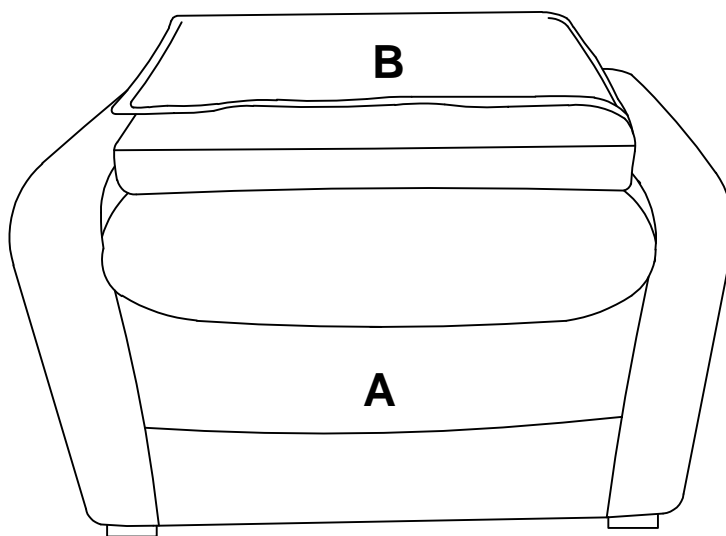

Step #1

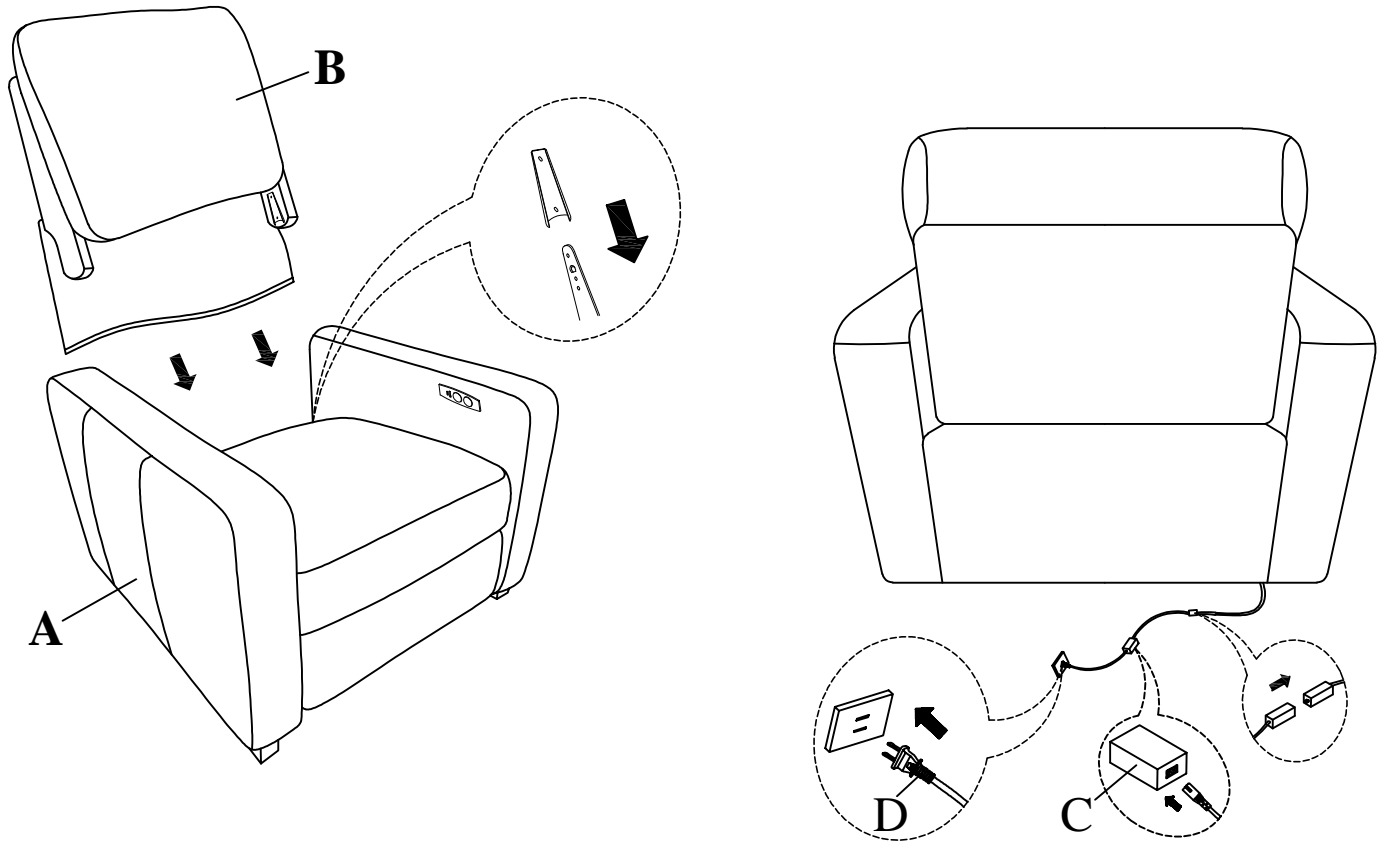

Step #2

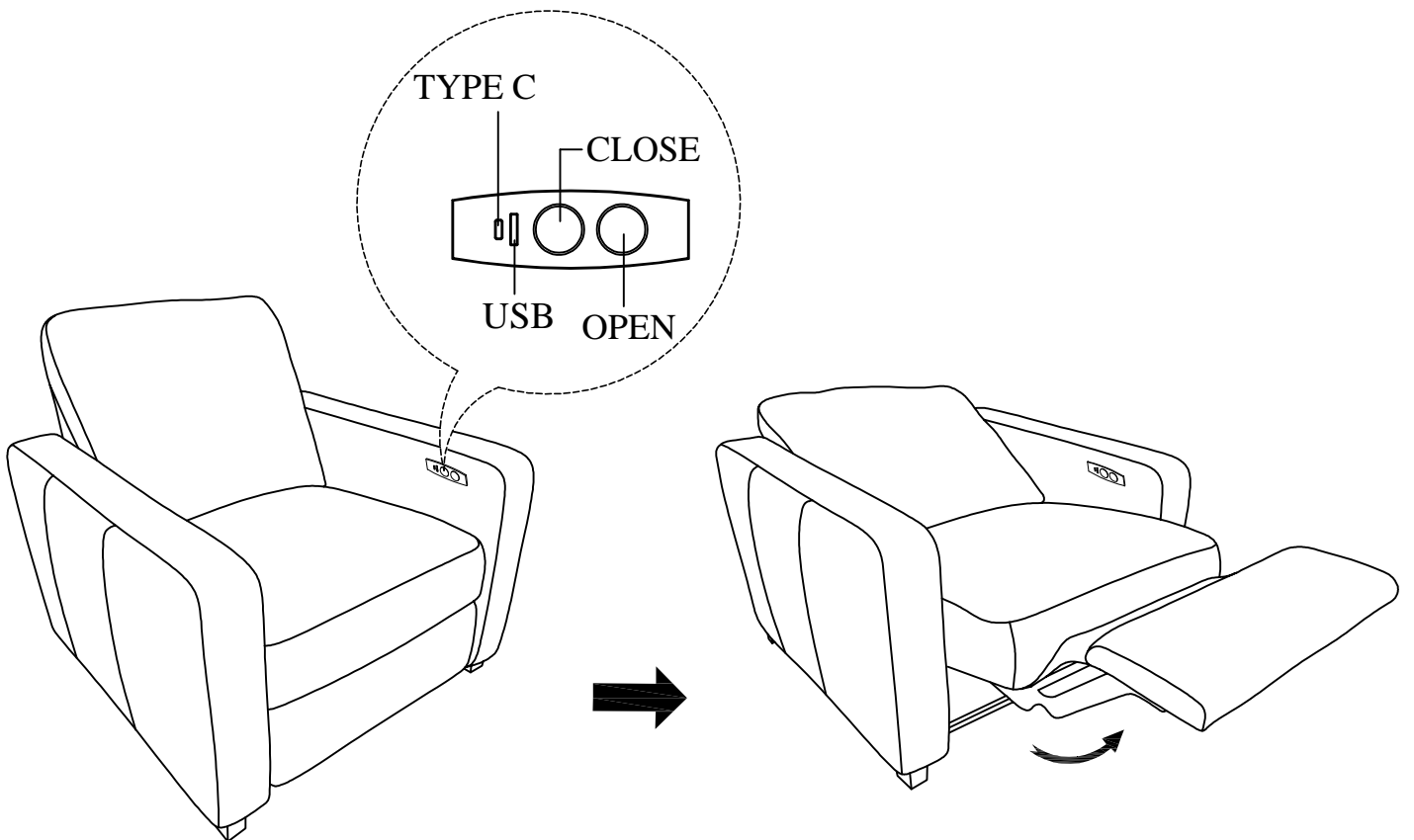

Step #3

Assembly completed.

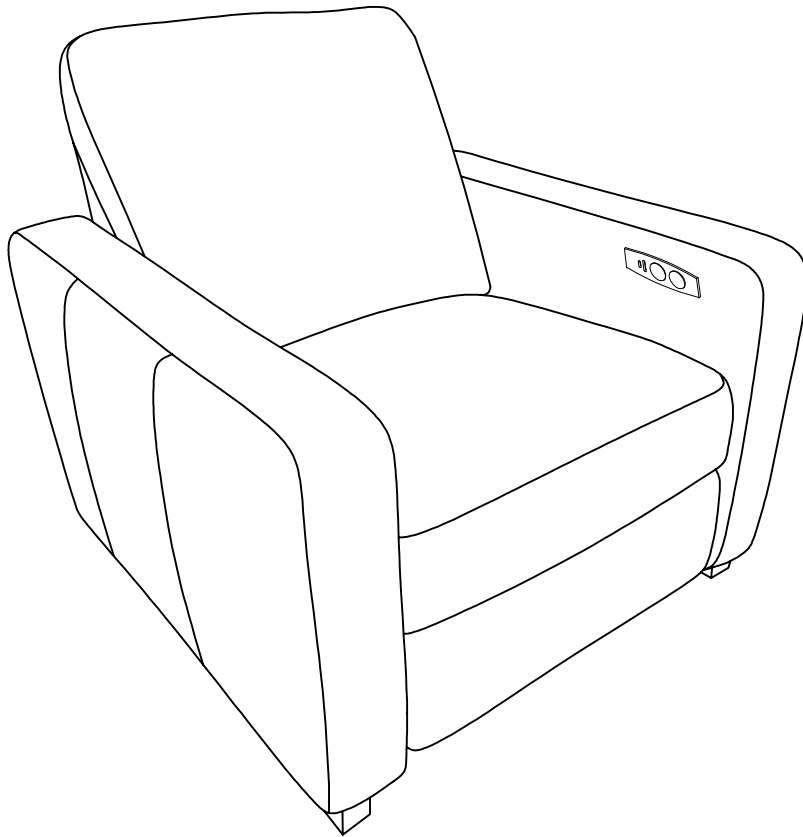

Care Instruction for Chenille Furniture:

In order to maintain the original appearance of your chenille fabric, please follow below simple care procedures:

- Avoid exposing furniture directly to sunlight or heating and air conditioning outlets. Sunlight and/or exposure to heating and air conditioning outlets will fade/damage chenille. Do not place your upholstered furniture too close to windows, radiators, or vents, and be sure to use windows, radiators, or vents.
- Vacuum or wipe with a soft cloth to remove dust.
- Hardware may loosen over time. Periodically check to make sure all connections are tight. Re-tighten if necessary.





For items use on wooden floor, hard surfaces or carpets, it is recommended to Install protective pads under all legs and supports to avoid/prevent from damages/scratches and discoloration.

Assembly Instruction

Power Double Reclining Love Seat With USB Ports

Note: Do not use power tools for assembly. Power tools increase the risk of over tightening which lead to splitting or cracking the wood.

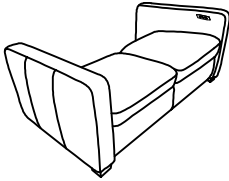
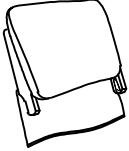
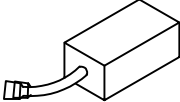
Component list

No	Drawing	Qty	Description
A		1	Seat
B		2	Backrest
C		1	Adaptor
D		1	Plug

THE PARTS ARE LOCATED INSIDE THE BOX AS BELOW:

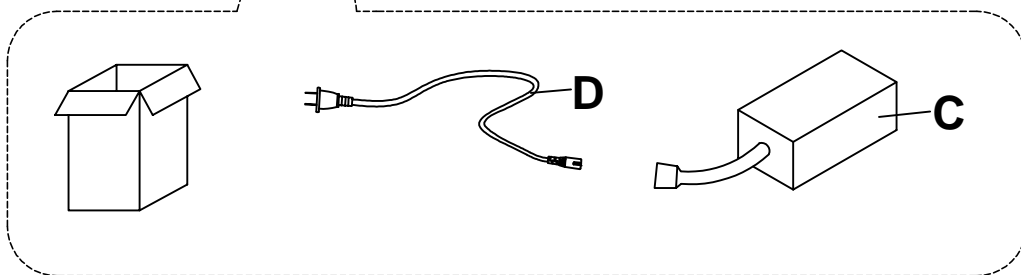
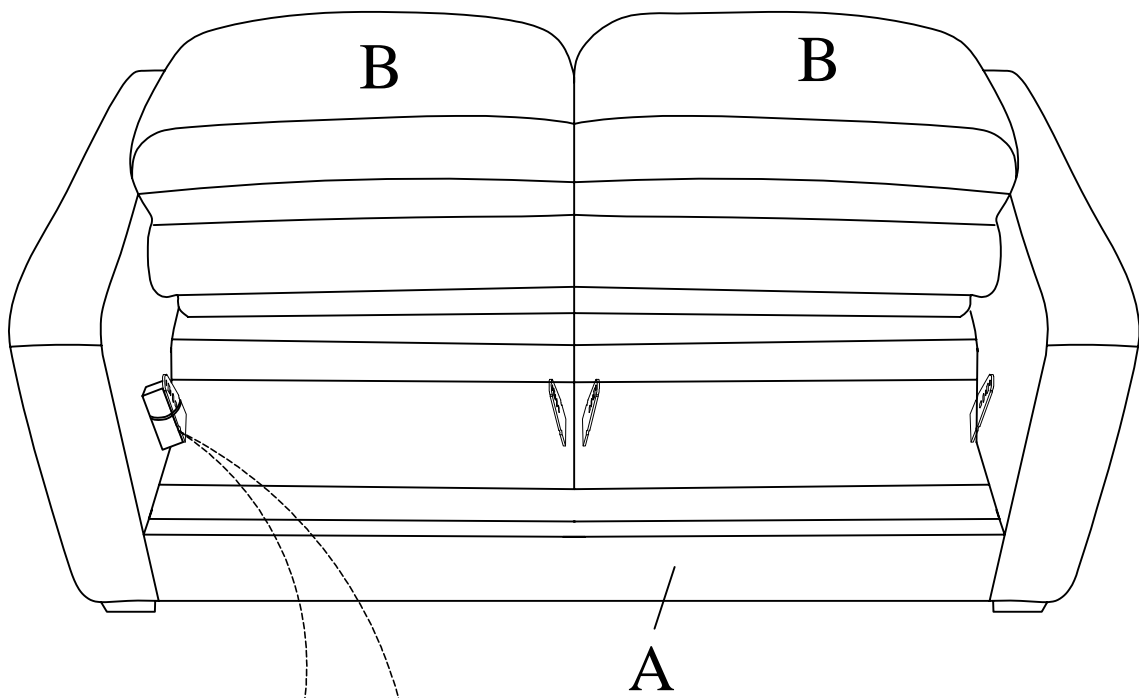
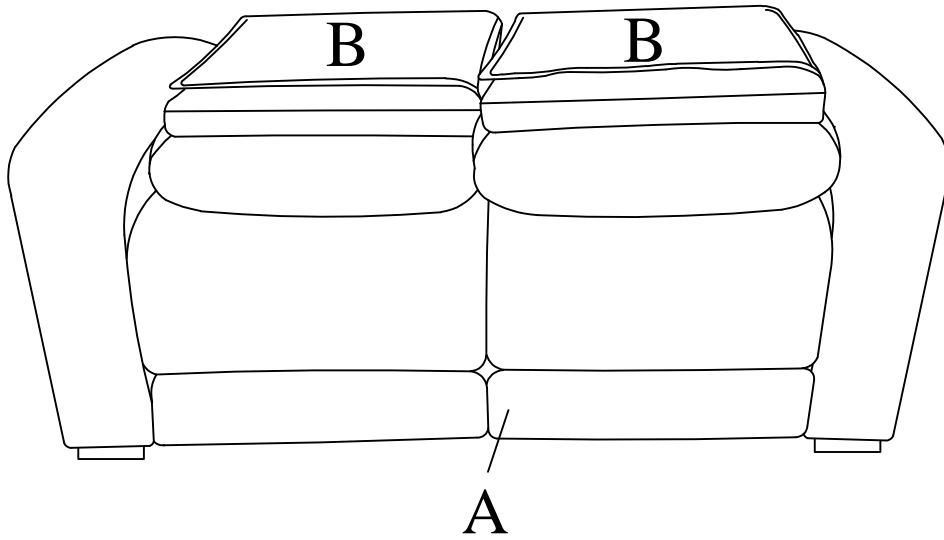

Step #1

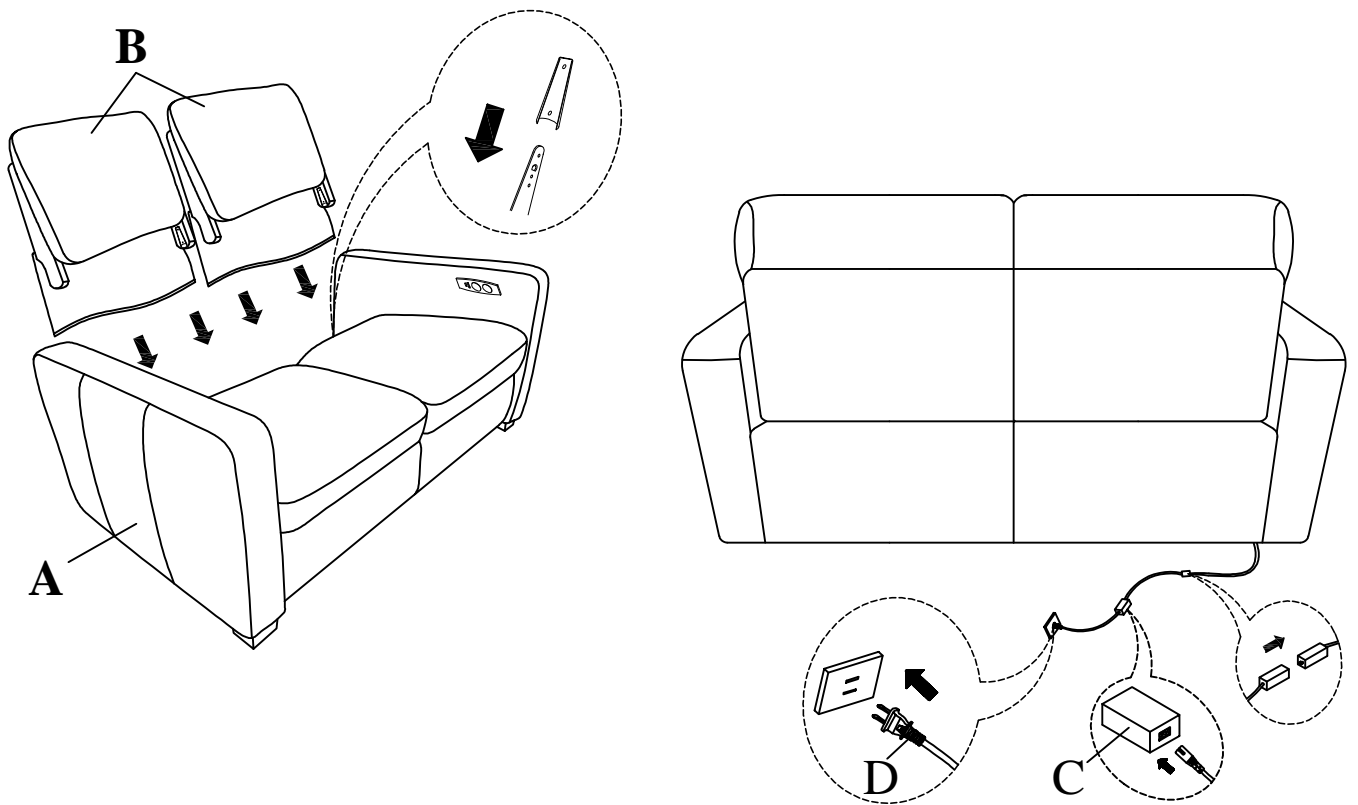

Step #2

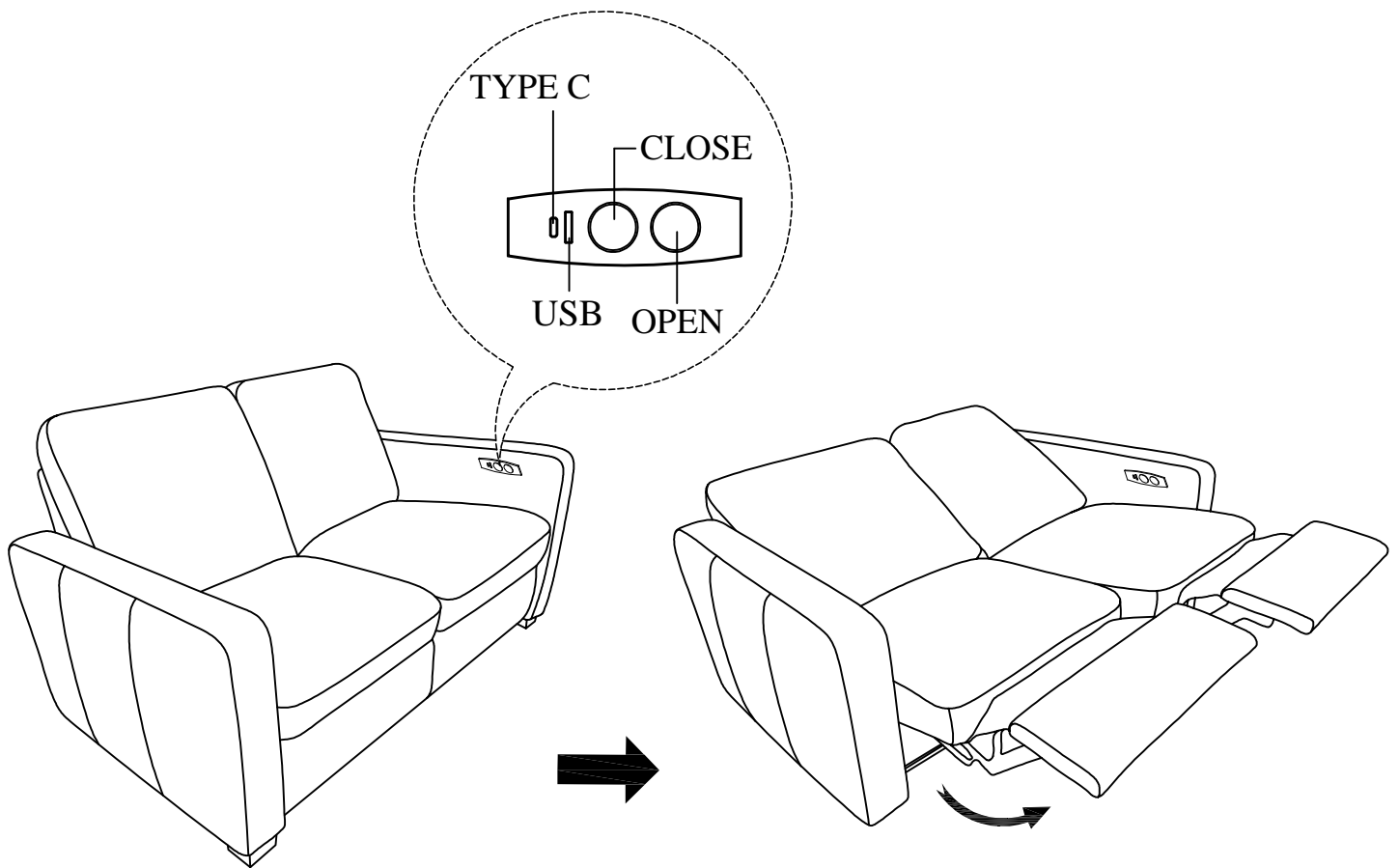

Step #3

Assembly completed.

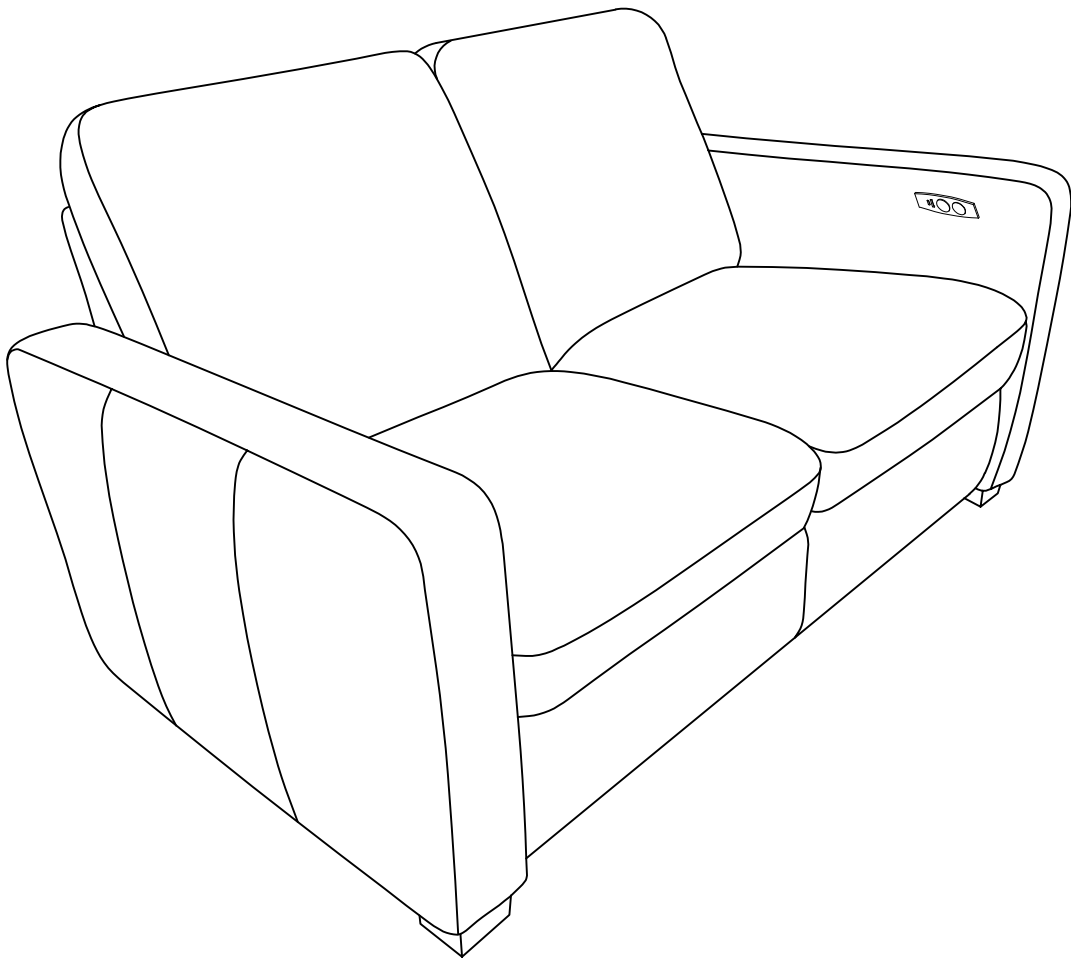

Care Instruction for Chenille Furniture:

In order to maintain the original appearance of your chenille fabric, please follow below simple care procedures:

- Avoid exposing furniture directly to sunlight or heating and air conditioning outlets. Sunlight and/or exposure to heating and air conditioning outlets will fade/damage chenille. Do not place your upholstered furniture too close to windows, radiators, or vents, and be sure to use windows, radiators, or vents.
- Vacuum or wipe with a soft cloth to remove dust.
- Hardware may loosen over time. Periodically check to make sure all connections are tight. Re-tighten if necessary.





For items use on wooden floor, hard surfaces or carpets, it is recommended to Install protective pads under all legs and supports to avoid/prevent from damages/scratches and discoloration.

Assembly Instruction

Power Double Reclining Sofa with USB Ports

Note: Do not use power tools for assembly. Power tools increase the risk of over tightening which lead to splitting or cracking the wood.

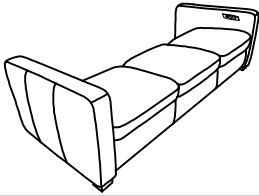
Component list

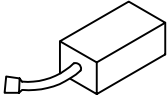
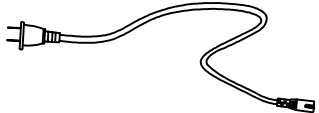
No	Drawing	Qty	Description
A		1	Seat
B		2	LSF/RSF Backrest
C		1	Middle Backrest
D		1	Adaptor
E		1	Plug

THE PARTS ARE LOCATED INSIDE THE BOX AS BELOW:

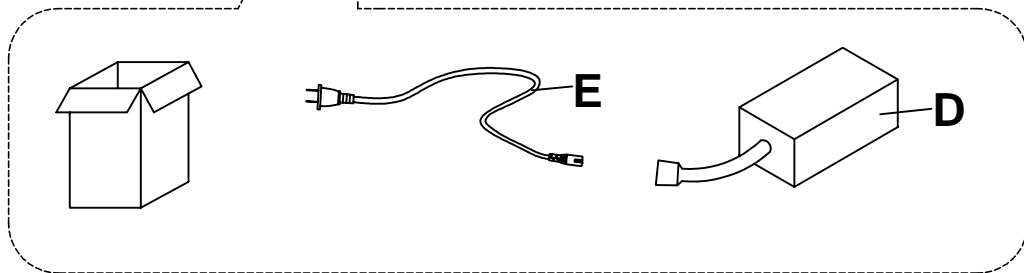
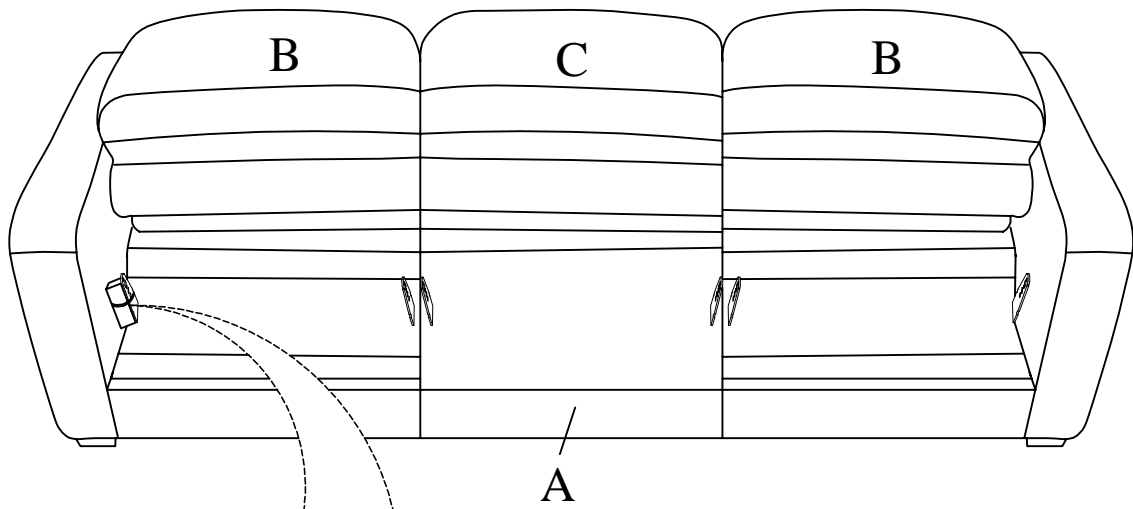
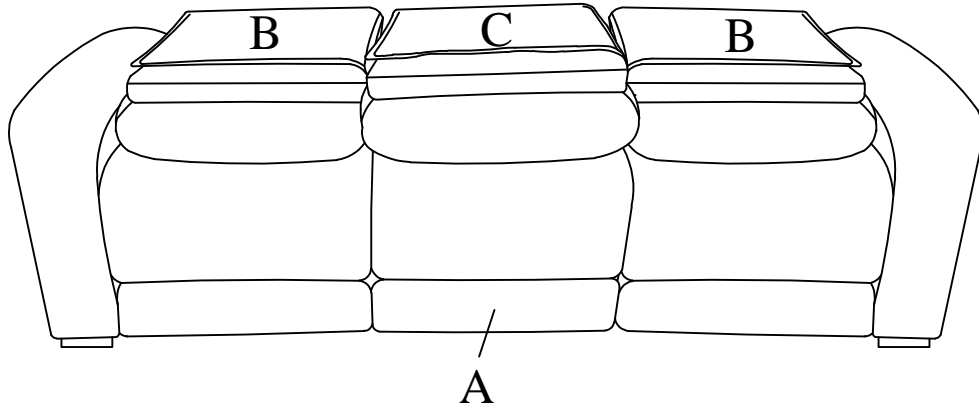

Step #1

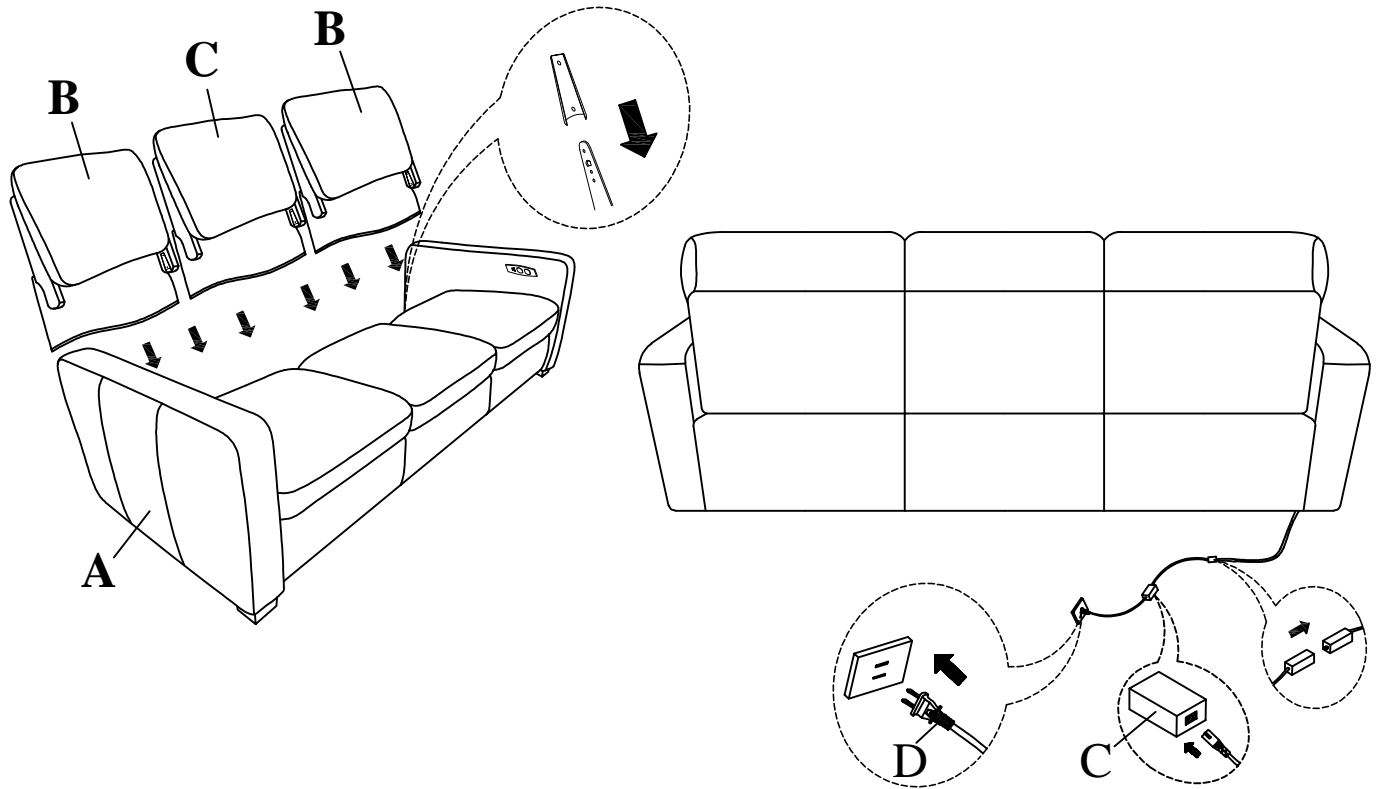

Step #2

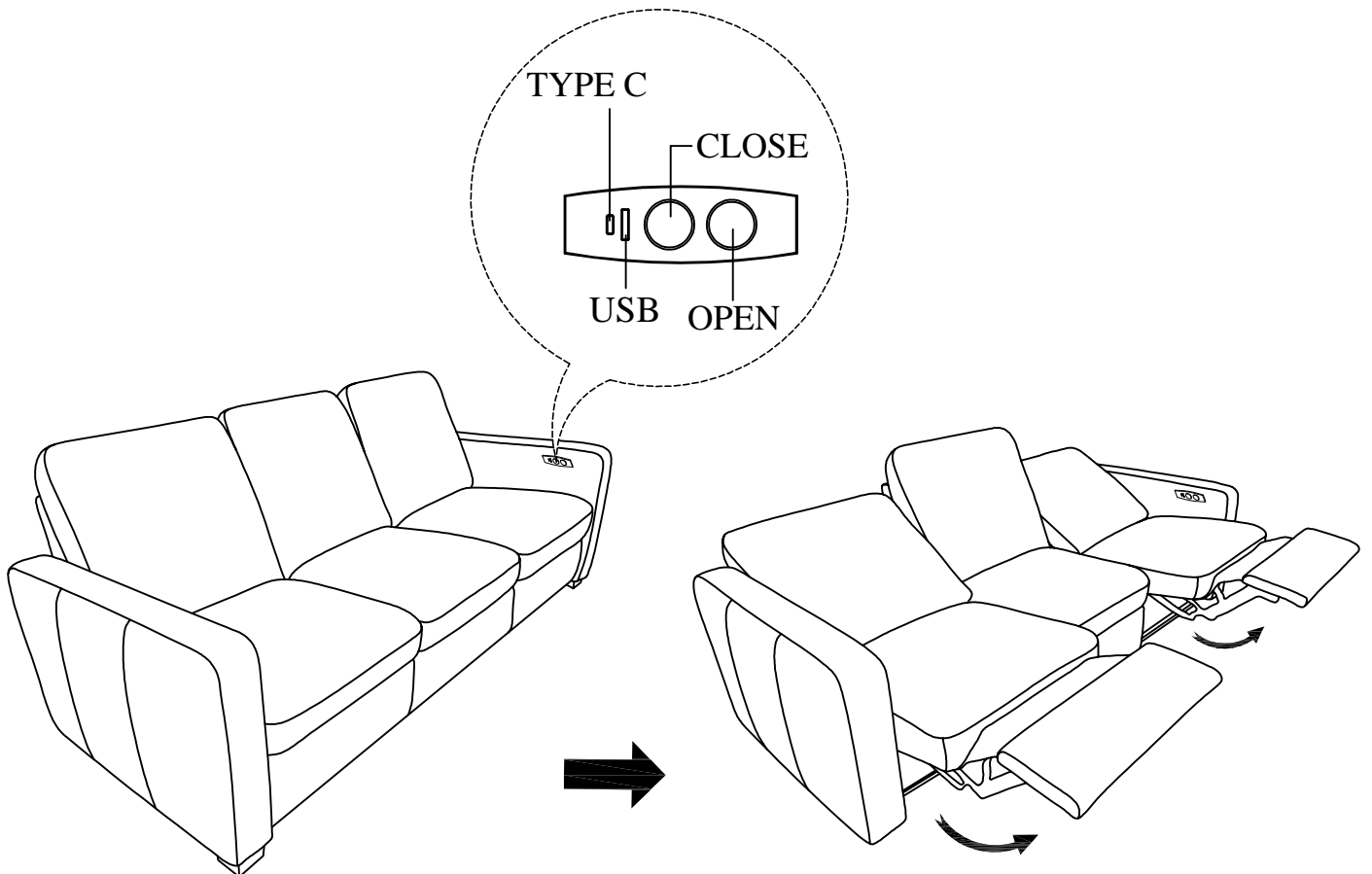

Step #3

Assembly completed.

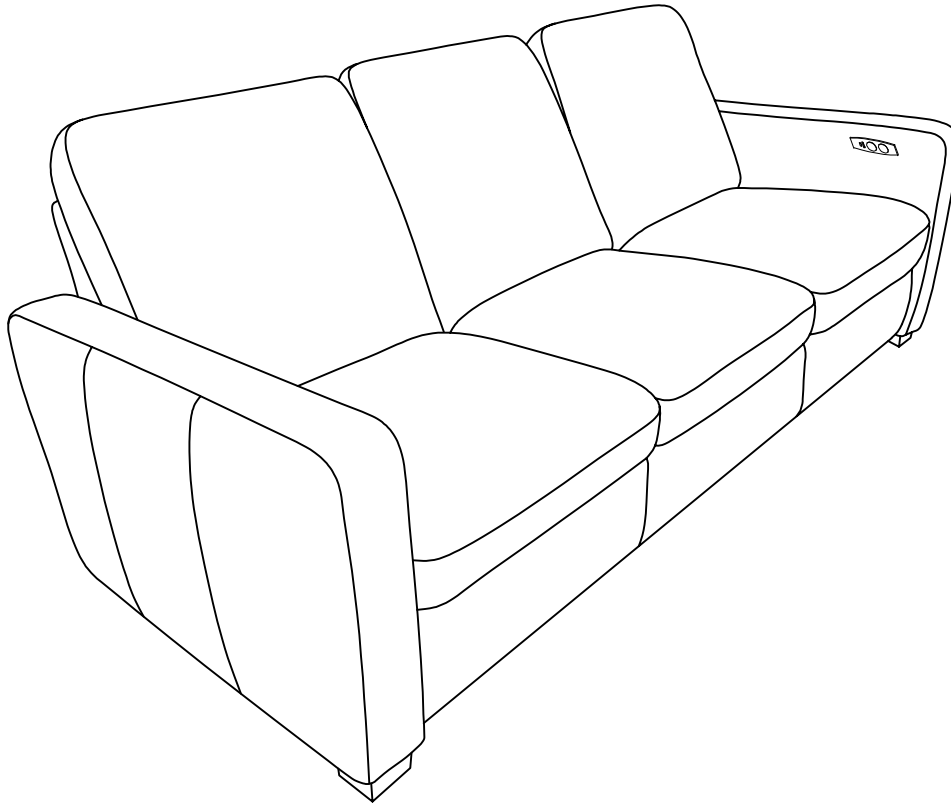

Care Instruction for Chenille Furniture:

In order to maintain the original appearance of your chenille fabric, please follow below simple care procedures:

- Avoid exposing furniture directly to sunlight or heating and air conditioning outlets. Sunlight and/or exposure to heating and air conditioning outlets will fade/damage chenille. Do not place your upholstered furniture too close to windows, radiators, or vents, and be sure to use windows, radiators, or vents.
- Vacuum or wipe with a soft cloth to remove dust.
- Hardware may loosen over time. Periodically check to make sure all connections are tight. Re-tighten if necessary.



For items use on wooden floor, hard surfaces or carpets, it is recommended to Install protective pads under all legs and supports to avoid/prevent from damages/scratches and discoloration.