

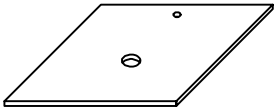









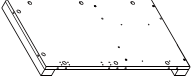

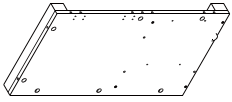

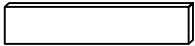
Bathroom Vanity HW1120

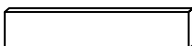
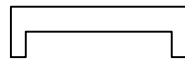
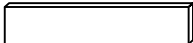

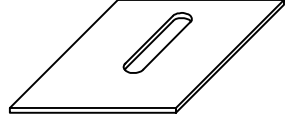
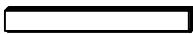

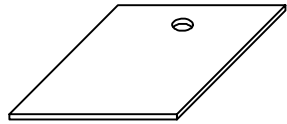
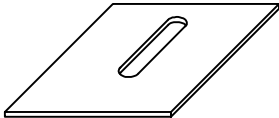
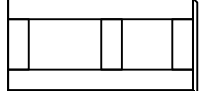
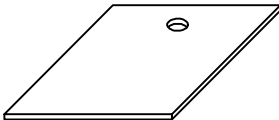
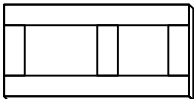
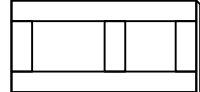
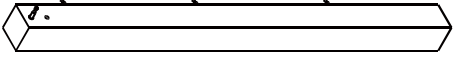
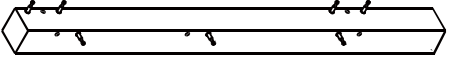
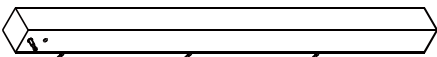
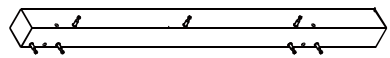
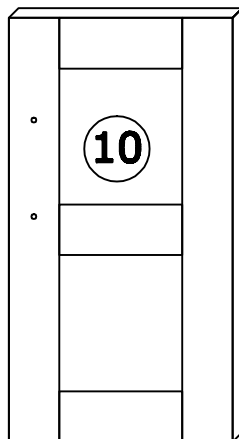
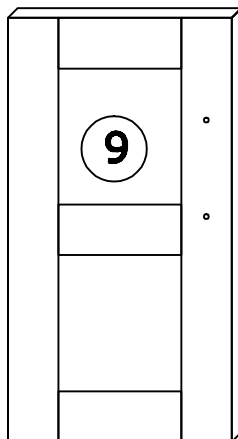
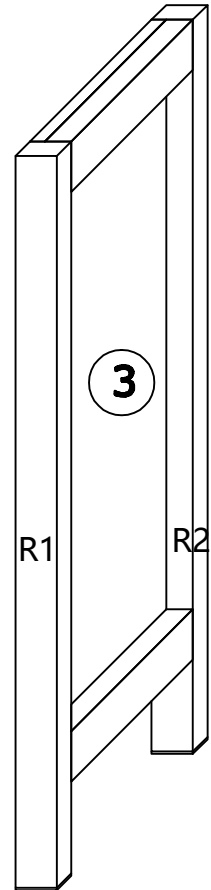
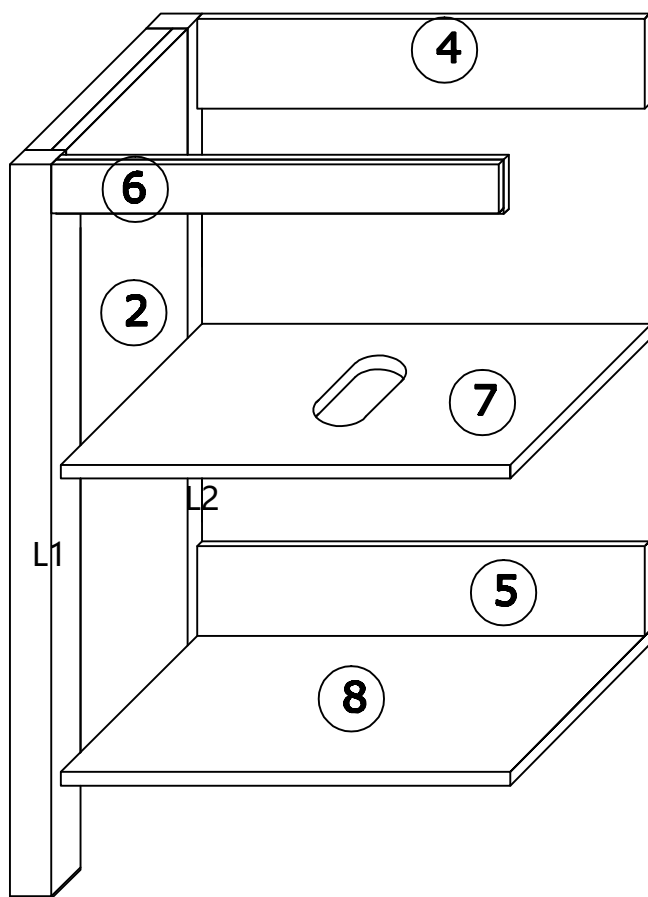
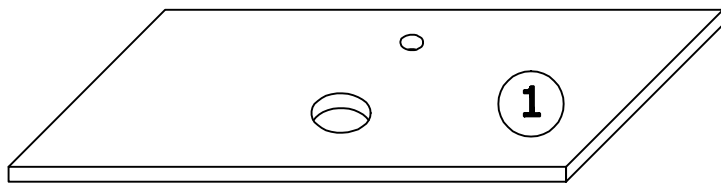
PARTS LIST			HARDWARE LIST		
NO.	DESCRIPTION	QTY	NO.	DESCRIPTION	QTY
1		1	A	 CAM LOCK	37
			B	 CAM SCREW	37
2		1	C	 CAM LOCK COVER	37
			D	 WOODEN DOWEL	26
3		1	E	 SCREW	40
			F	 HINGE	4
4		1	G	 HASCREW ($\phi 4 \times 18 \text{MM}$)	4
			H	 HANDLE 128MM	2
5		1	I	 $\phi 3.5 \times 35 \text{MM}$	2
			J	 $\phi 6 \times 30 \text{MM}$	2
6		1	K	 BOTTOM DRAIN HOLE COVER	1
			L	 CORNER IRON	2
7		1	M	 COUNTER TOP BASIN HOLDER	1
8		1			
9		1			
10		1			
L1		1			
L2		1			
R1		1			
R2		1			

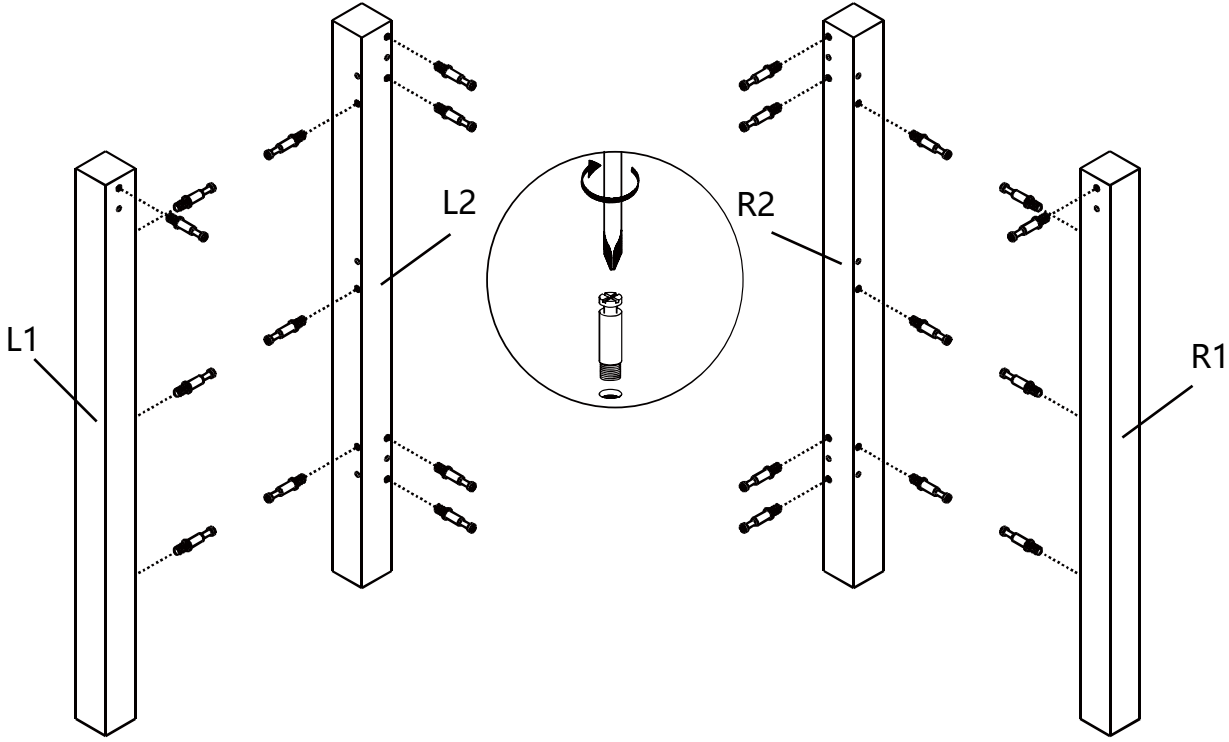
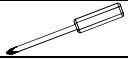

HARDWARE LIST	
B 	22 pcs



HARDWARE LIST	
A 	12 pcs
C 	12 pcs
D 	14 pcs

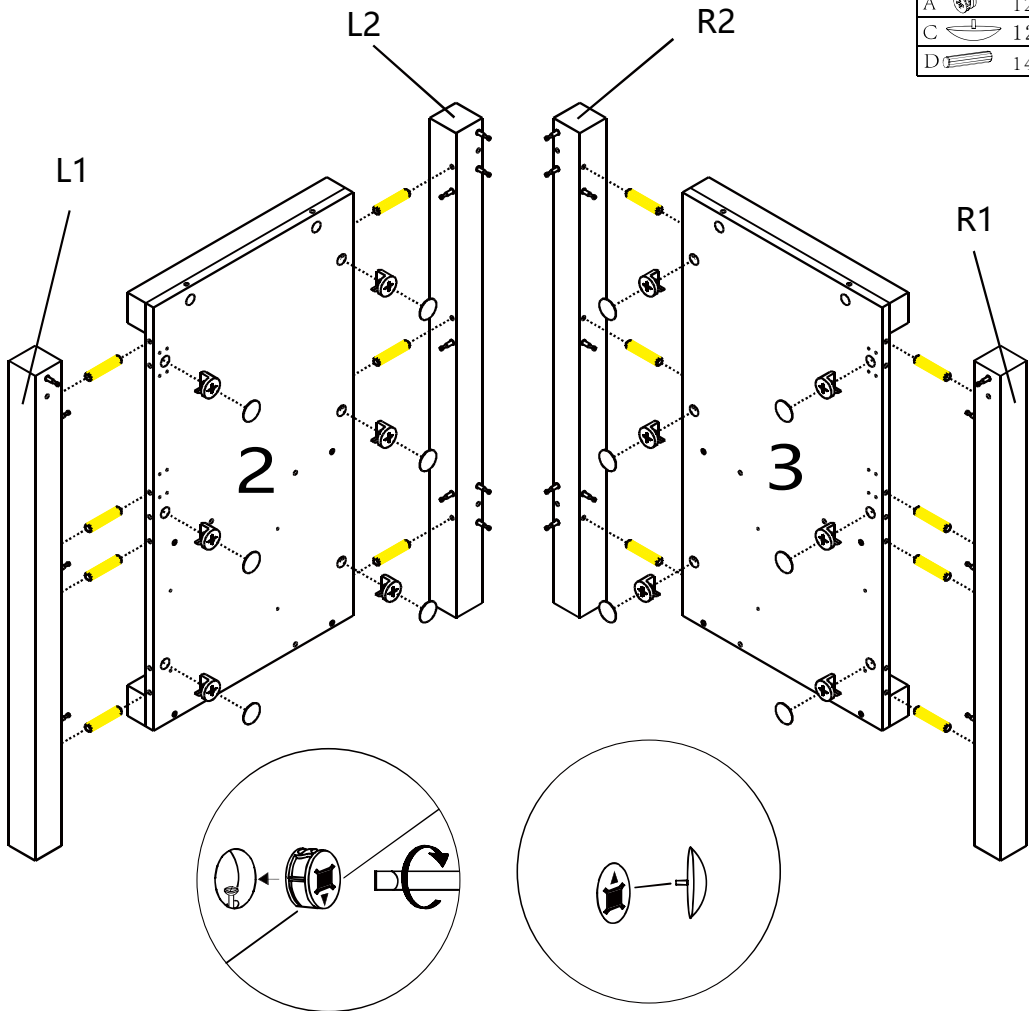
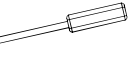

STEP 1

HARDWARE LIST

B 25 PCS

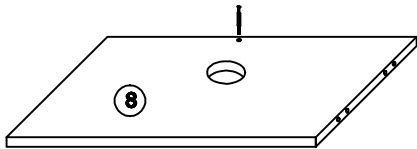
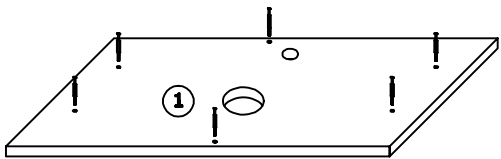
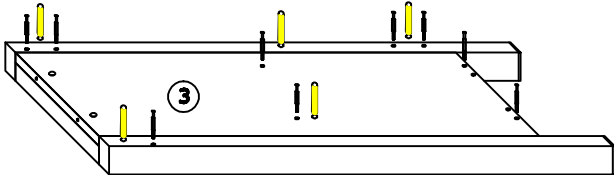
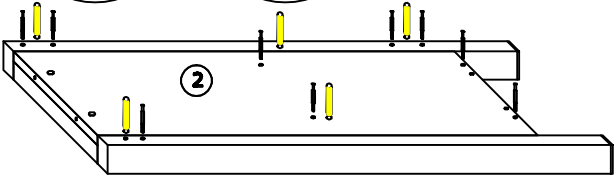
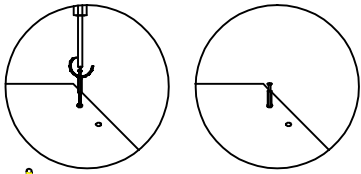

STEP 2

HARDWARE LIST

D 14 PCS

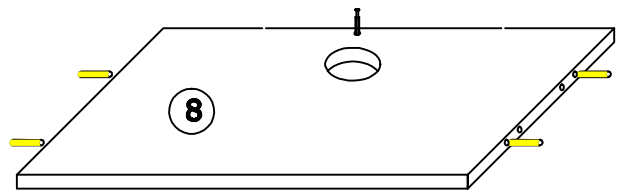
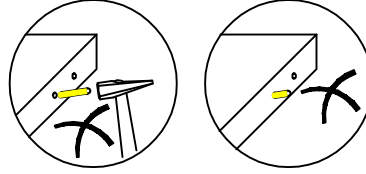
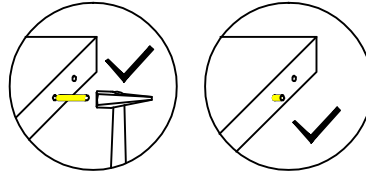

STEP 3

HARDWARE LIST

A 1 PCS

C 1 PCS

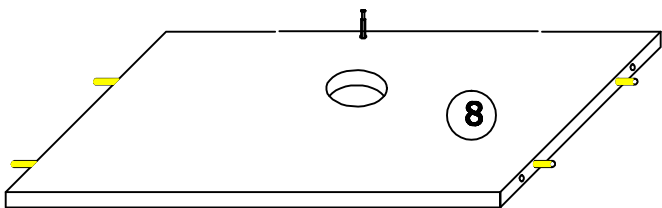
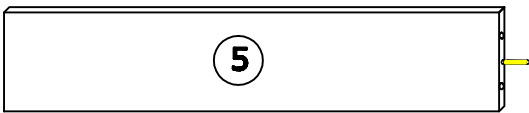
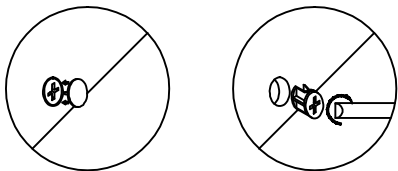

STEP 4



HARDWARE LIST

A 9 PCS

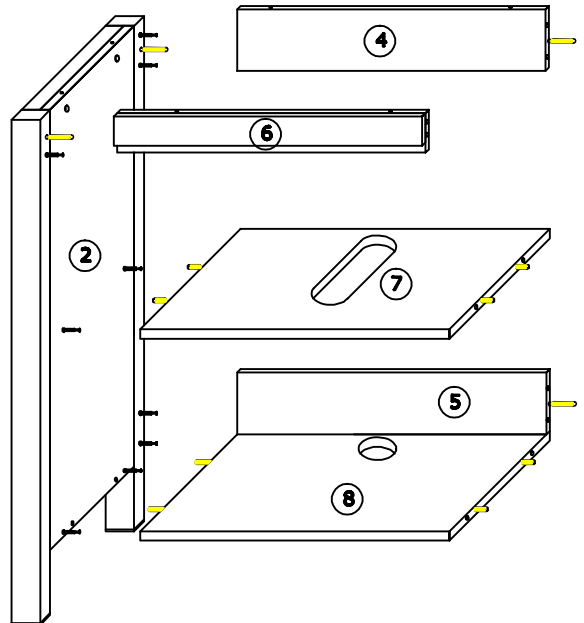
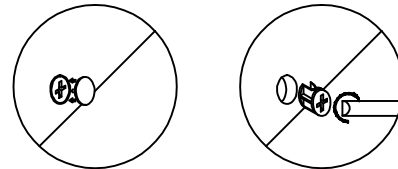

C 9 PCS





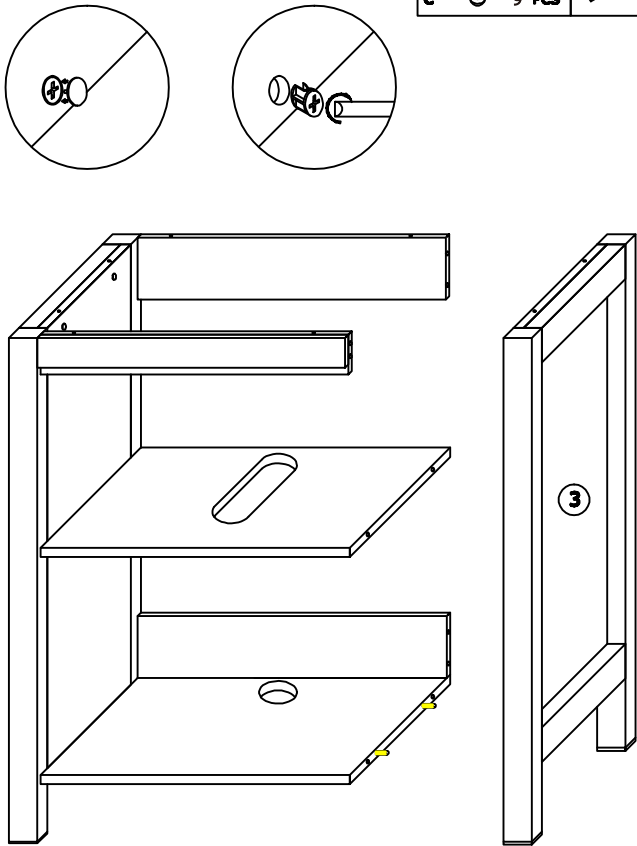

STEP 5**HARDWARE LIST**

A		9 PCS	
C		9 PCS	

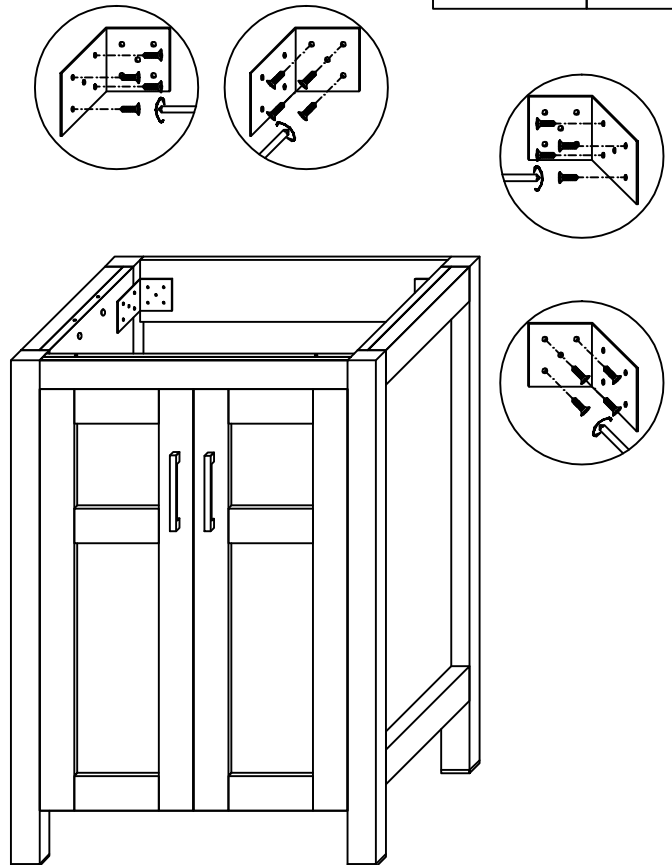

**STEP 6****HARDWARE LIST**

M		2PCS	
E		16 PCS	

**STEP 7****HARDWARE LIST**

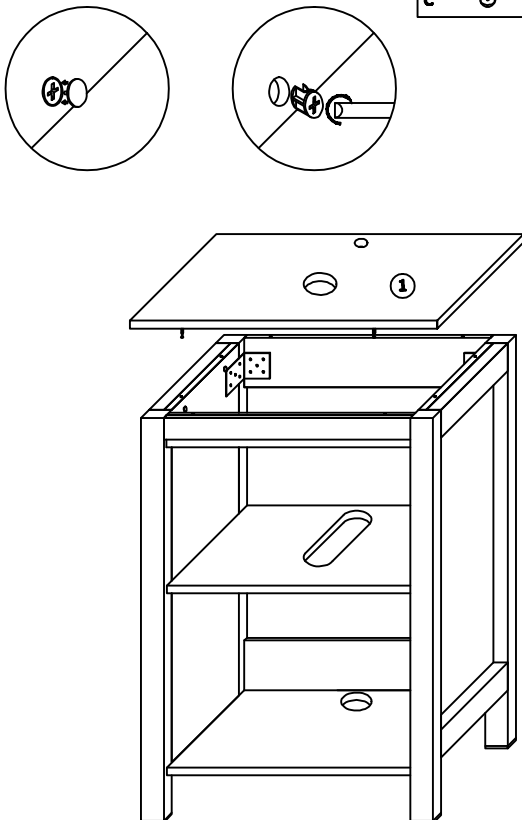
A		6 PCS	
C		6 PCS	

**STEP 8****HARDWARE LIST**

E		40 PCS	
F		4PCS	

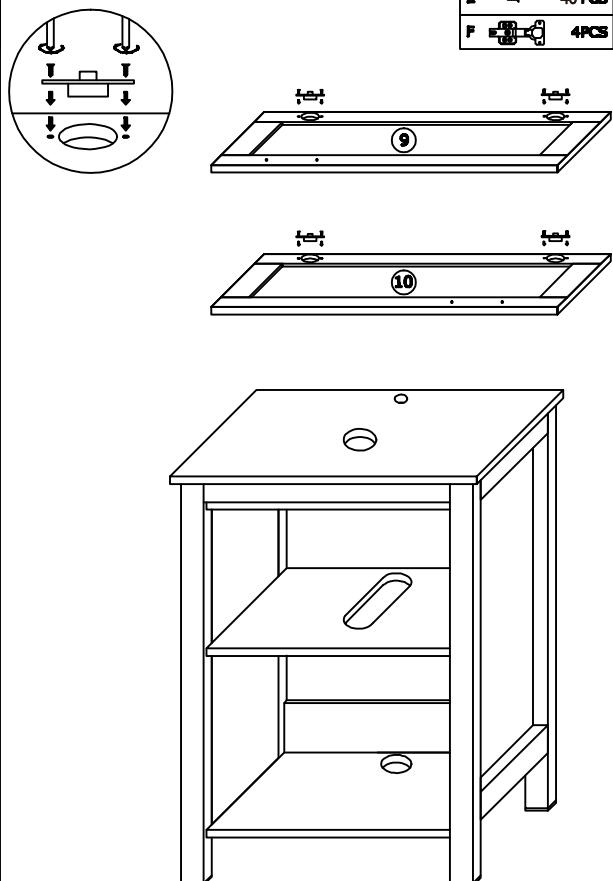

STEP 9

HARDWARE LIST	
E	1 16 PCS
G	4PCS
H	2PCS

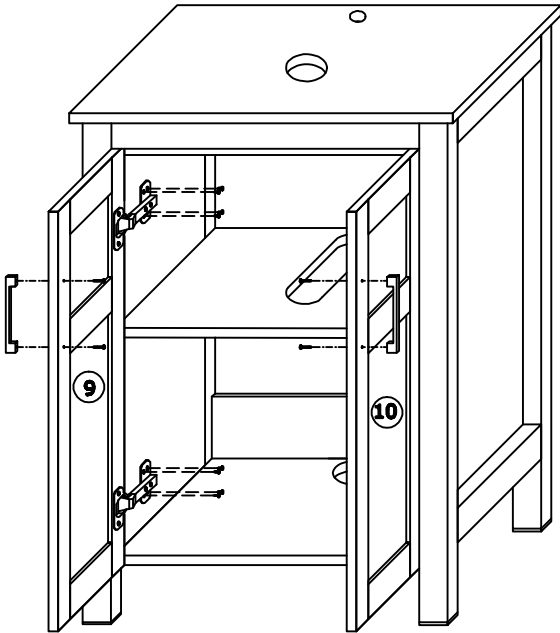
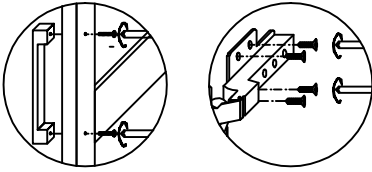

STEP 10

A. Height adjustment;
B. Depth adjustment;
C. Side to side adjustment.

HARDWARE LIST	

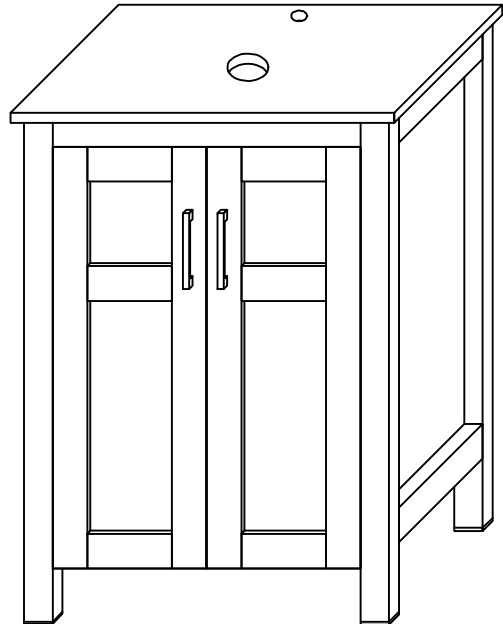
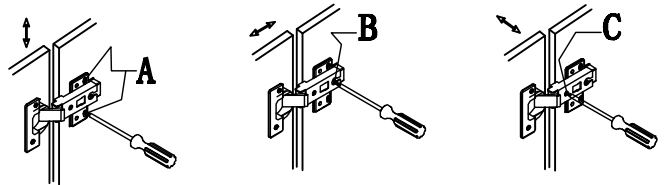

STEP 11

HARDWARE LIST	

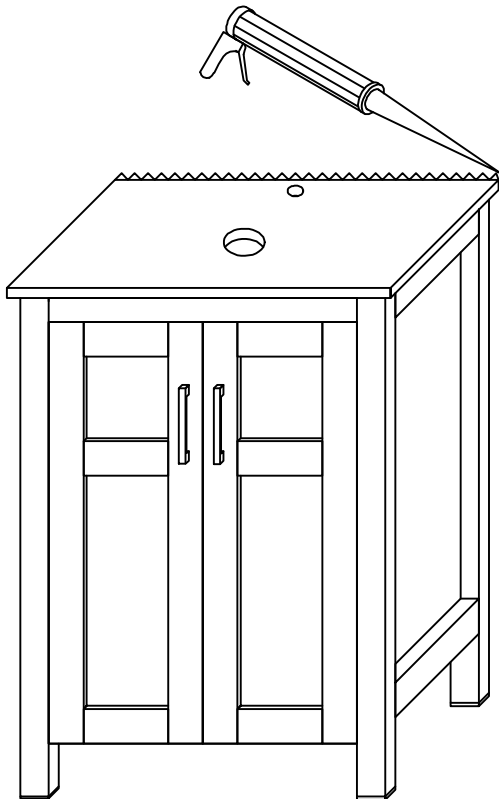

STEP 12

HARDWARE LIST	

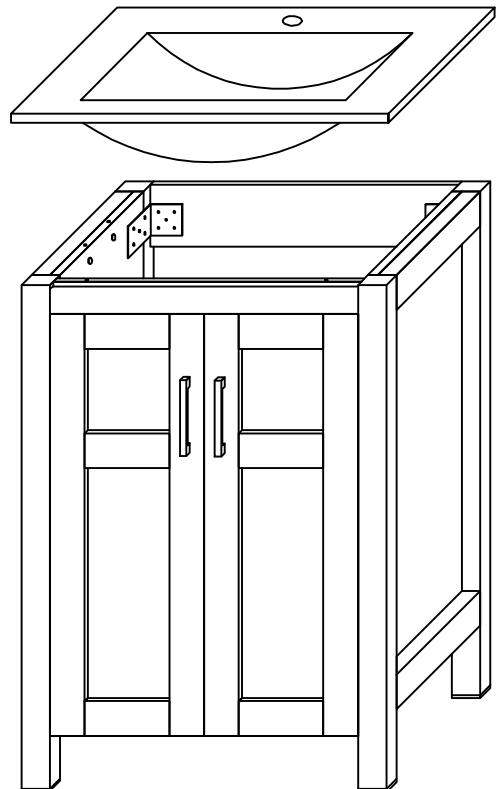

STEP 13

HARDWARE LIST

STEP 14

HARDWARE LIST

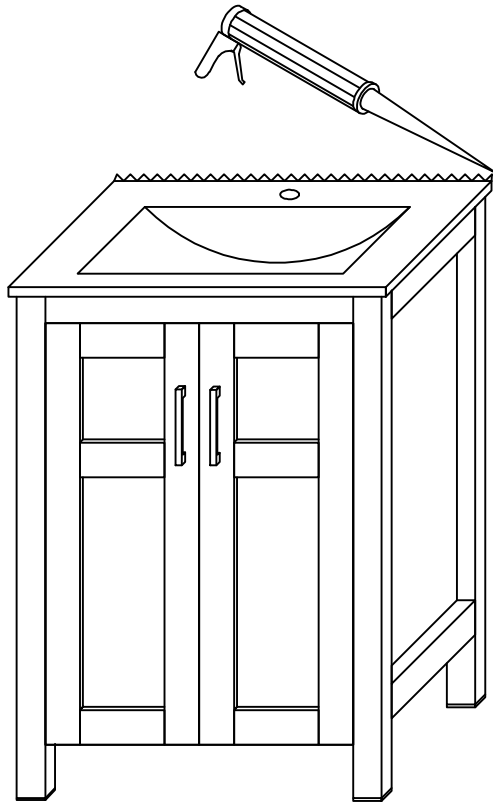

STEP 15

HARDWARE LIST

STEP 16

HARDWARE LIST