

Early Education by Flash Furniture



Hercules Wooden STEAM Wall Accessory Board

Overview

Enhance fine motor skills, gross motor skills, and hand-eye coordination with these wooden accessory boards. These items can be mounted on the wall, featured in floor play, or used with the Early Education by Flash Furniture art easels.

Skills

- Fine Motor Skills
- Gross Motor Skills
- Hand Eye Coordination

Hercules Wooden STEAM Wall Accessory Board, Tie it- Turn it
MK-ME15303-GG

To Play

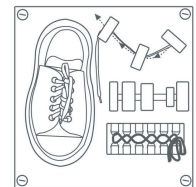
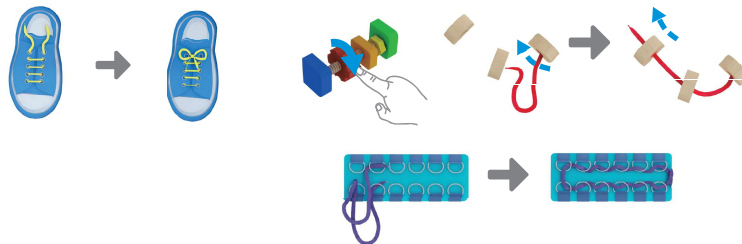

Hercules Wooden STEAM Wall Accessory Board, Locks & Buckles
MK-ME12531-GG

To Play

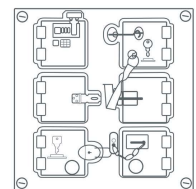
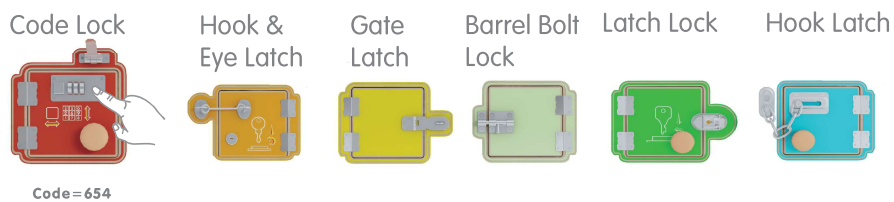

Hercules Wooden STEAM Wall Accessory Board, Turning Gears
MK-ME14719-GG

To Play

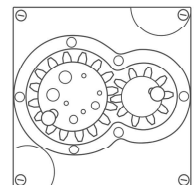

Hercules Wooden STEAM Wall Accessory Board, Butterfly Life Cycle
MK-ME12883-GG

To Play

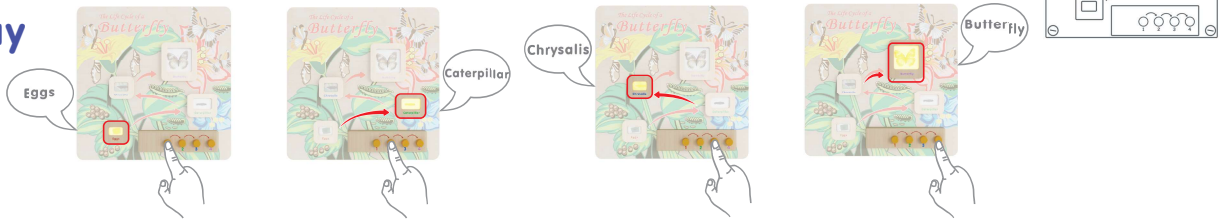

Hercules Wooden STEAM Wall Accessory Board, Healthy Hygiene
MK-ME10346-GG

To Play

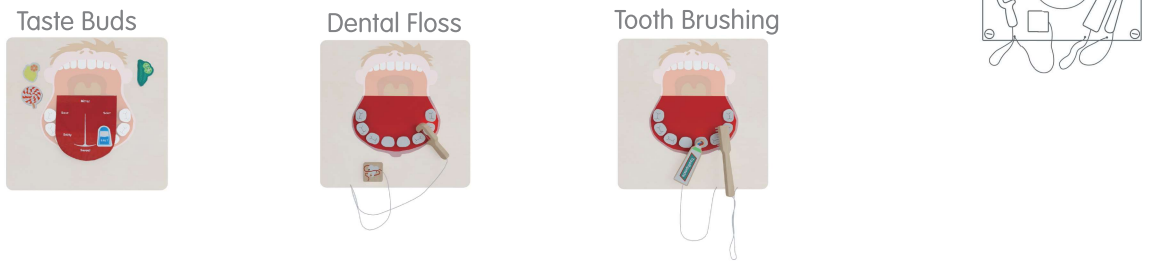

Hercules Wooden STEAM Wall Accessory Board, Feelings + Moods
MK-ME15273-GG

To Play

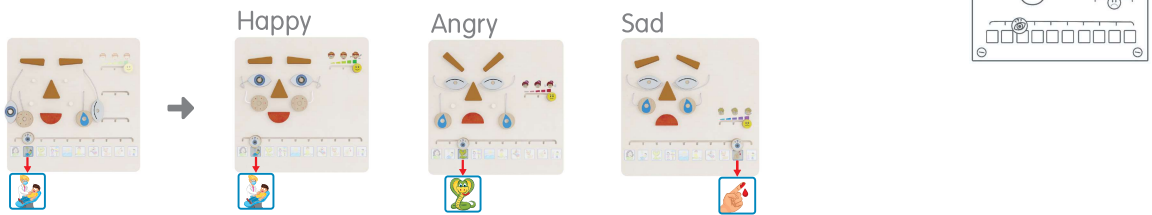

Hercules Wooden STEAM Wall Accessory Board, Weather
MK-ME16393-GG

To Play

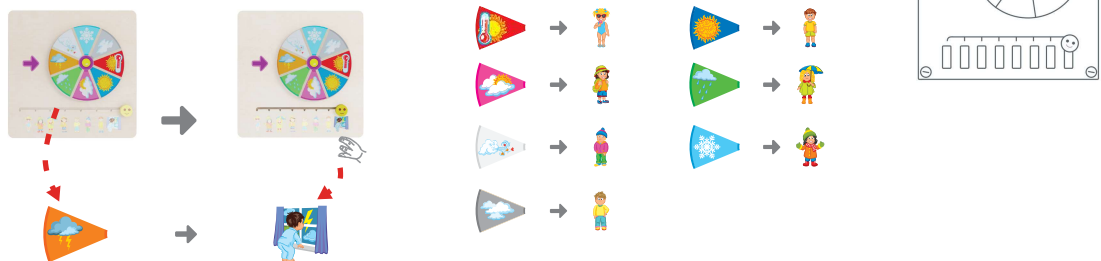

Hercules Wooden STEAM Wall Accessory Board, Time
MK-ME09609-GG

To Play

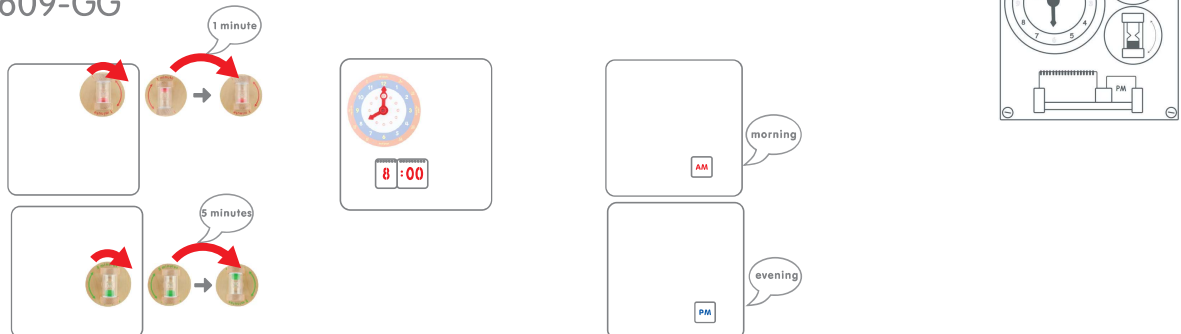

Hercules Wooden STEAM Wall Accessory Board, Counting
MK-ME09524-GG

To Play

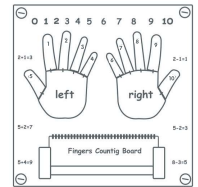
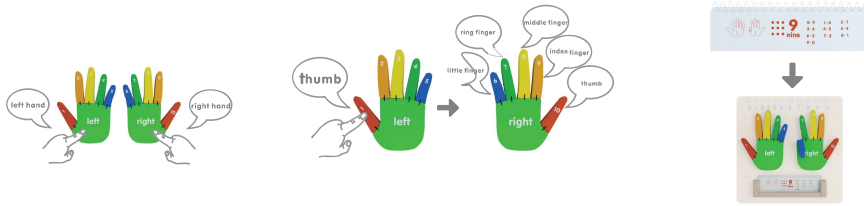

Hercules Wooden STEAM Wall Accessory Board, Maze Motor Skills
MK-ME14337-GG

To Play

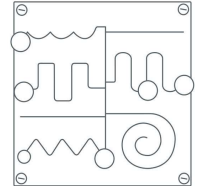
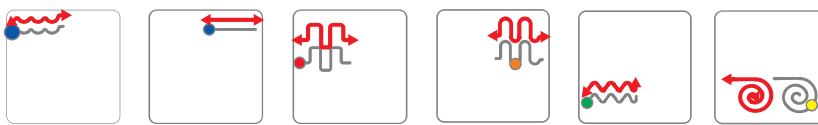

Hercules Wooden STEAM Wall Accessory Board, Motor Skills
MK-ME03713-GG

To Play

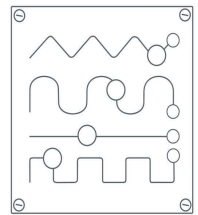
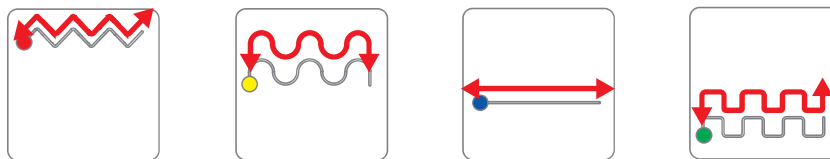

Hercules Wooden STEAM Wall Accessory Board, Magnetic Chalk Board
MK-ME088002-GG

To Play

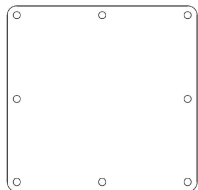



Congratulations!

You just purchased a piece of happiness. At Belnick, we believe you can transform your spaces into the most inspired places with furnishings that are the perfect combination of form, function and style. As original innovators of online furniture retail, we offer the best selection of popular, contemporary styles at cool, comfortable prices. And, with decades of proven shipping and packaging expertise, our Extended Quality Checklist ensures a rewarding, hassle-free experience time and time again. It's just what you need to bring your vision to life.

Thank you & Enjoy!!

your friends at Belnick



LIKE IT!

*Share it on social
& Tell a friend!
#Spaces2Places*



LOVE IT!

*Write an online
product review
where purchased*



NOT SURE?

*Let us help!
Contact our
customer support.*

Have a question, concern or simply need a hand? Your satisfaction is our top priority. Contact us at 866-552-2810 or customerexperience@belnick.com. We're here to help!

Browse Our Branded Collections

There's something for everyone inside our family of brands.



MERRICK | LANE

Emma+Oliver®

TAYLOR + LOGAN

BlackArc®

Visit www.belnick.com/brands or scan this code to go even faster!



BELNICK

ONE VISION. ENDLESS POSSIBILITIES.



We pride ourselves on providing an excellent customer experience starting right here with your package and instructions. Everything you need should be right where you need it, so you can get to enjoying your new item ASAP. But despite our best efforts, sometimes "slips happen." If you need any support, from replacement parts to recommendations, please reach out to our wonderful customer support team at 866-552-2810 or customerexperience@belnick.com. We're here to help!

EVERY BELNICK PRODUCT



Quality &
Durability Tested



Packaged
with Care



Shipped from
our U.S. Facility

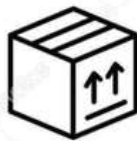

Designed
for Easy
Assembly



Ethically
Sourced

Please visit <https://www.belnick.com/warranty> for complete warranty information.

Read this manual before using this product. Failure to follow the instructions and safety precautions in this manual can result in serious injury or death. Keep this manual in a safe location for future reference.

Compatible Products

Hercules Wooden Train
STEAM Wall System with 5
Accessory Panel Holders
MK-ME06486-GG

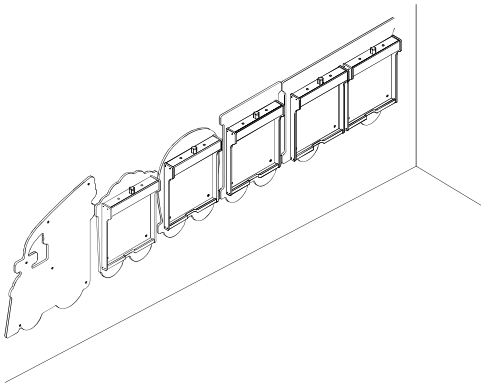

Hercules Wooden STEAM
Wall System, Holds 3
Accessory Panel
MK-ME03669-GG

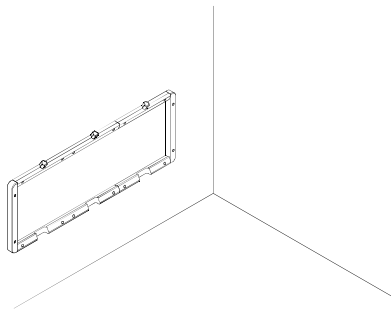

Hercules Free-Standing
STEAM Easel
MK-ME03669-GG

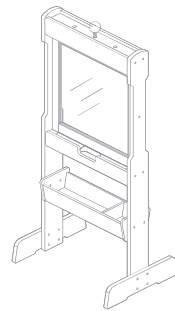

We take pride in our play, products and planet. All of our materials are ethically sourced and constructed of premium-grade wood materials. Other environmentally-friendly materials, like non-toxic waterbased colors, soy ink and recycled packaging, are utilized across our entire collection.

Maintenance

Our products are preservative-free, so nothing is added that may contaminate or pollute. In exchange, a little extra care is needed. Please keep your new items in a low humidity and wipe them clean and dry regularly.