

Assembly Instruction

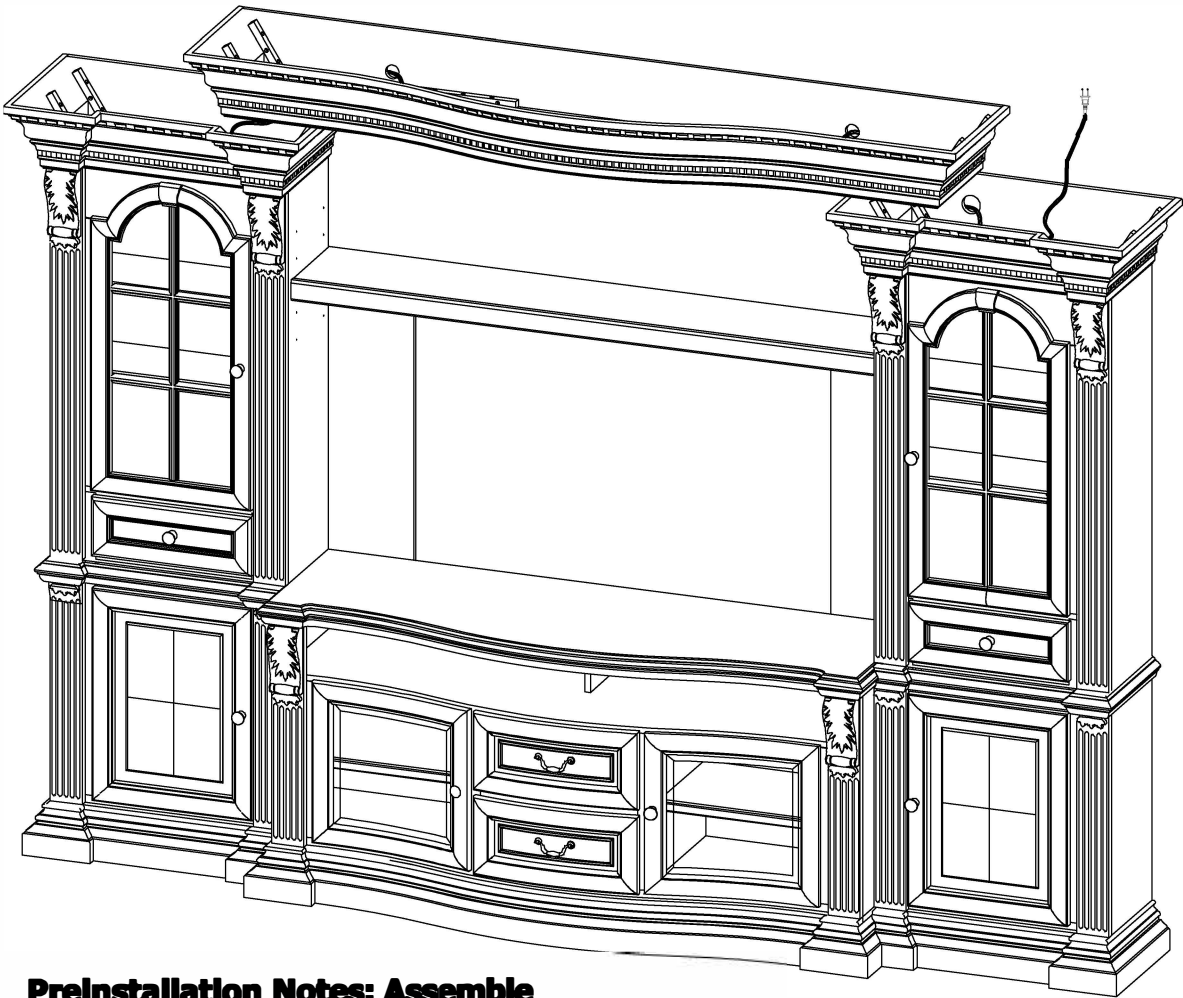

Preinstallation Notes: Assemble wall near or at final position with at least 2 people. Level all pieces prior to assembly.

**Tools needed for assembly:
Phillips-head screwdriver,
flat-head screwdriver**

Assembly Instruction

HARDWARE

NO	DESCRIPTION	SKETCH	QTY
	TOUCH UP PEN		1PC



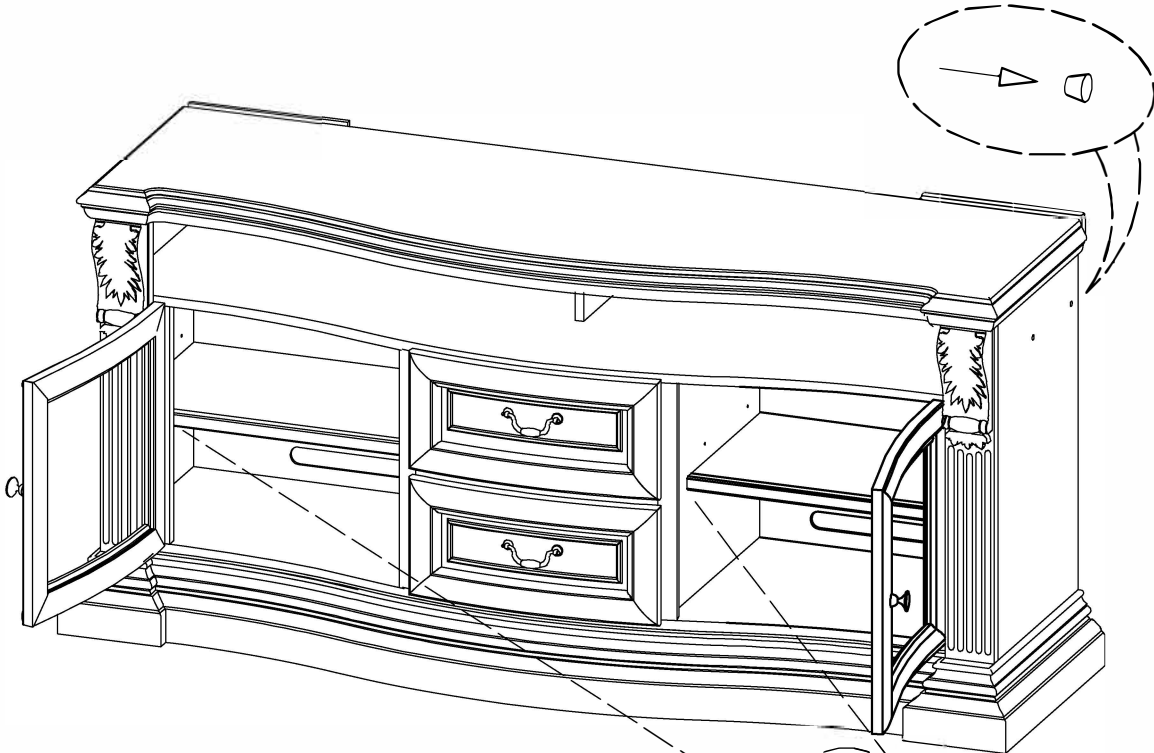

Please remove wood plugs when used in conjunction with piers.



For shipping purposes, adjustable shelves are secured in place. To adjust, please remove screws under each shelf pin. Re-place pins and shelf to desired position. It is recommended to re-secure screws to shelf.

Assembly Instruction

HARDWARE

NO	DESCRIPTION	SKETCH	QTY
A	WOOD SCREWS 1"		4PCS
B	SHELF PIN		8PCS
C	WOOD PLUG		2PCS
	TOUCH UP PEN		1PC

Secure crowns to top of Pier with Wood Screws (A).
IMPORTANT: Screws are only meant to secure crown to Pier, and are non-load bearing. Crowns do not offer any support when moving pier.

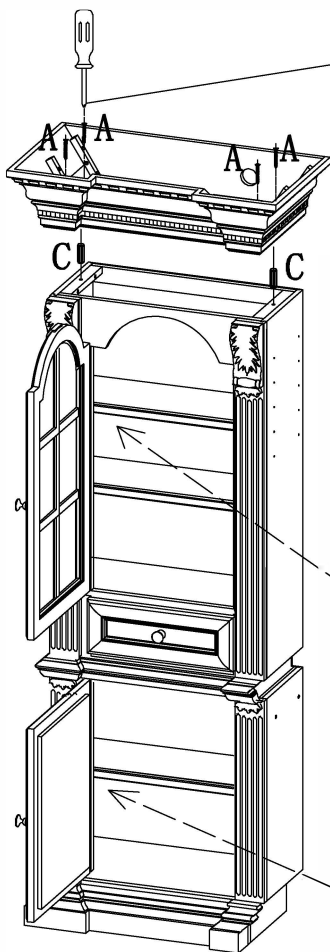

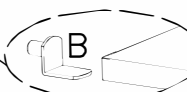

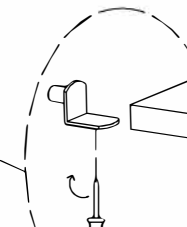

 For ease, it is recommended to position adjustable shelves from top to bottom.

 For shipping purposes, bottom shelf is secured in place. To adjust, please remove screws under each shelf pin. Re-place pins and shelf to desired position. It is recommended to re-secure screws to shelf.

Assembly Instruction

HARDWARE

NO	DESCRIPTION	SKETCH	QTY
A	WOOD SCREWS 1"		4PCS
B	SHELF PIN		8PCS
C	WOOD PLUG		2PCS
	TOUCH UP PEN		1PC

Secure crowns to top of Pier with Wood Screws (A).
IMPORTANT: Screws are only meant to secure crown to Pier, and are non-load bearing. Crowns do not offer any support when moving pier.

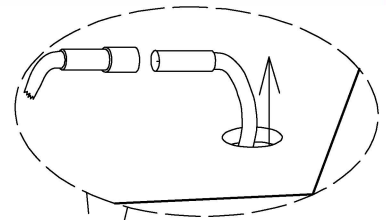

For ease, it is recommended to position adjustable shelves from top to bottom.

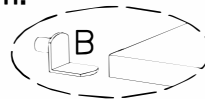

For shipping purposes, bottom shelf is secured in place. To adjust, please remove screws under each shelf pin. Re-place pins and shelf to desired position. It is recommended to re-secure screws to shelf.

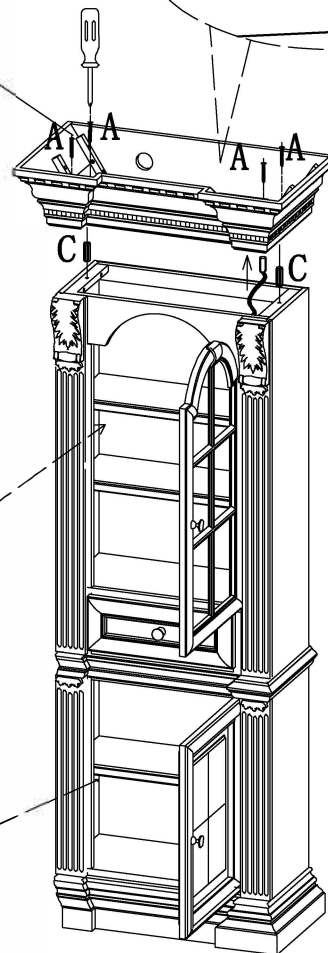
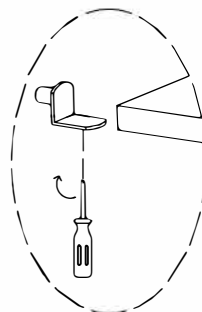

Assembly Instruction

HARDWARE

NO	DESCRIPTION	SKETCH	QTY
A	ALLEN KEY		2PCS
B	28mm BOLT		4PCS
C	SCREW CAP		4PCS
D	FLAT WASHER		4PCS
	TOUCH UP PEN		1PC

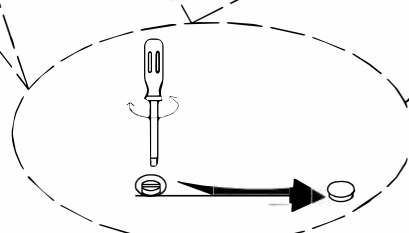
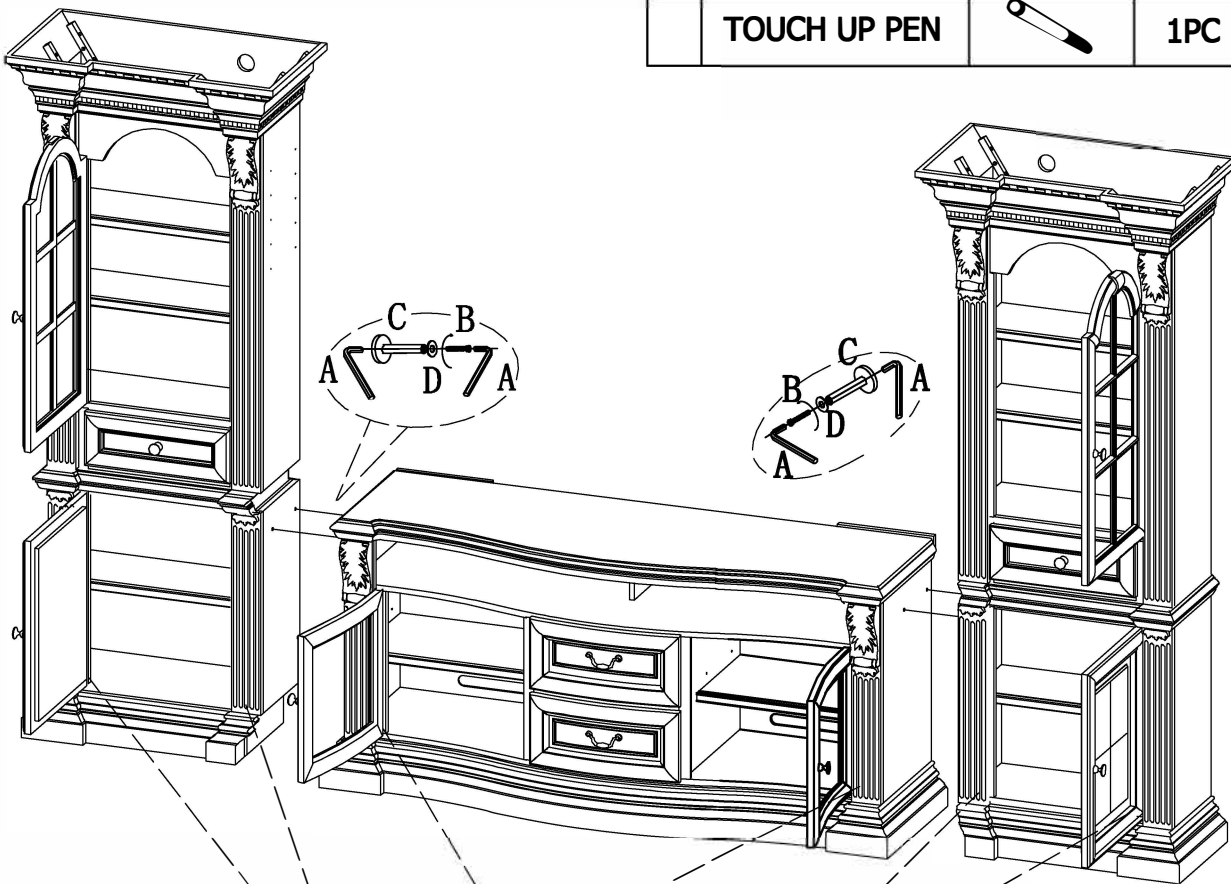

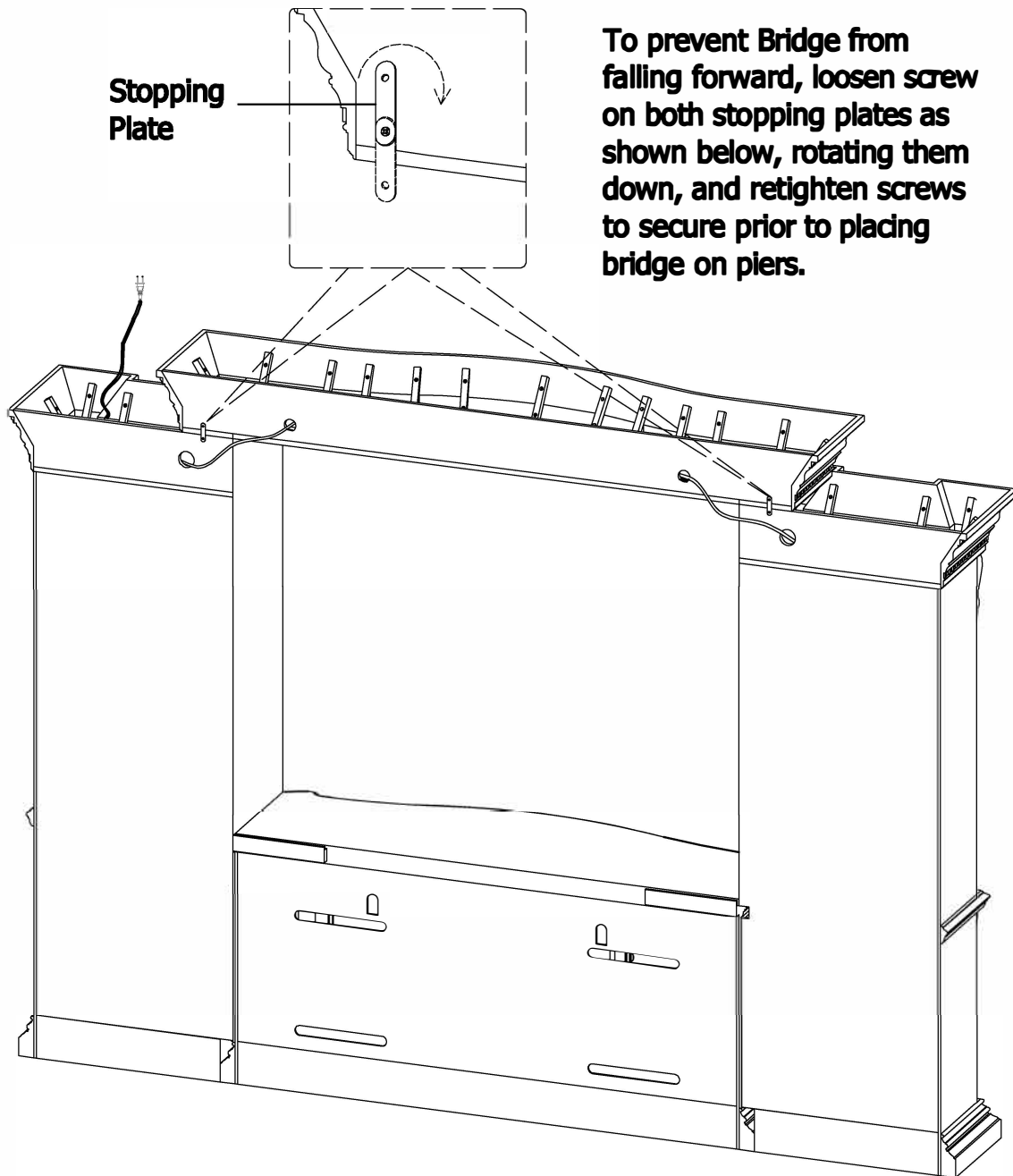

To adjust and access levelers, first remove plastic cap with a flat-head screwdriver. Using the same screwdriver, proceed to turn leveler clockwise to raise the piece, or counterclockwise to lower the piece.

Assembly Instruction



Assembly Instruction

HARDWARE

NO	DESCRIPTION	SKETCH	QTY
A	HOOKING		4PCS
B	WOOD SCREW 1/2"		16PCS
	TOUCH UP PEN		1PC

Hook the L shape bracket on upper back panel into the hole on the bridge back

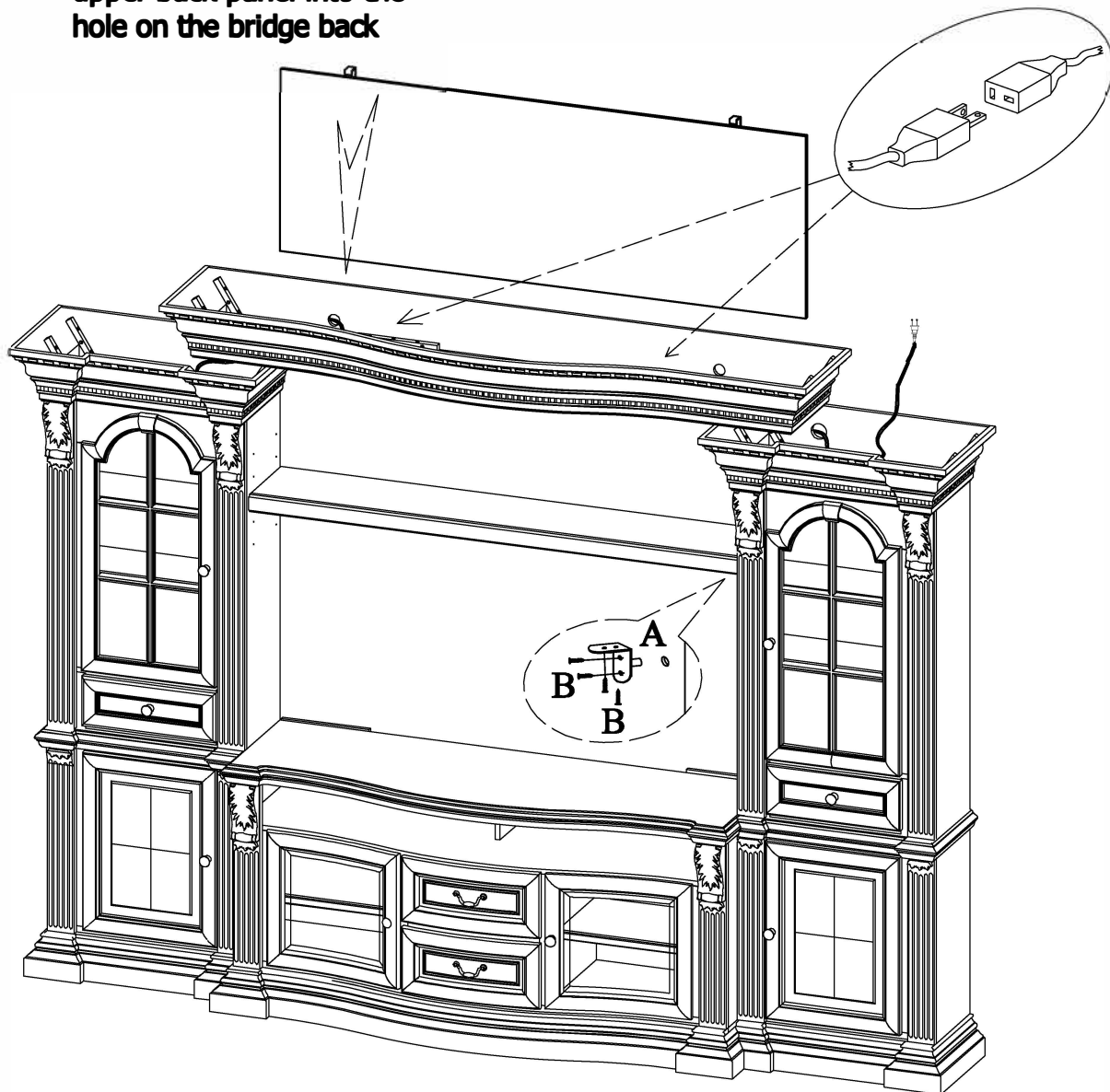

Assembly Instruction

HARDWARE

NO	DESCRIPTION	SKETCH	QTY
	TOUCH UP PEN		1PC

Position backpanel wings into slotted grooves found at console's top rear, and fasten to backpanel with connecting clips.

