

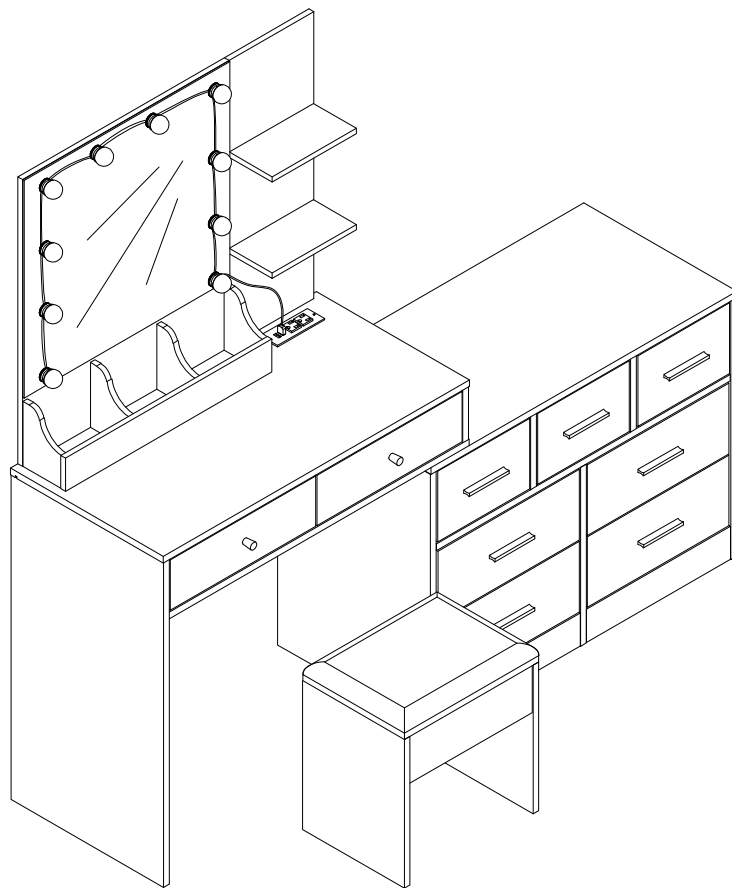

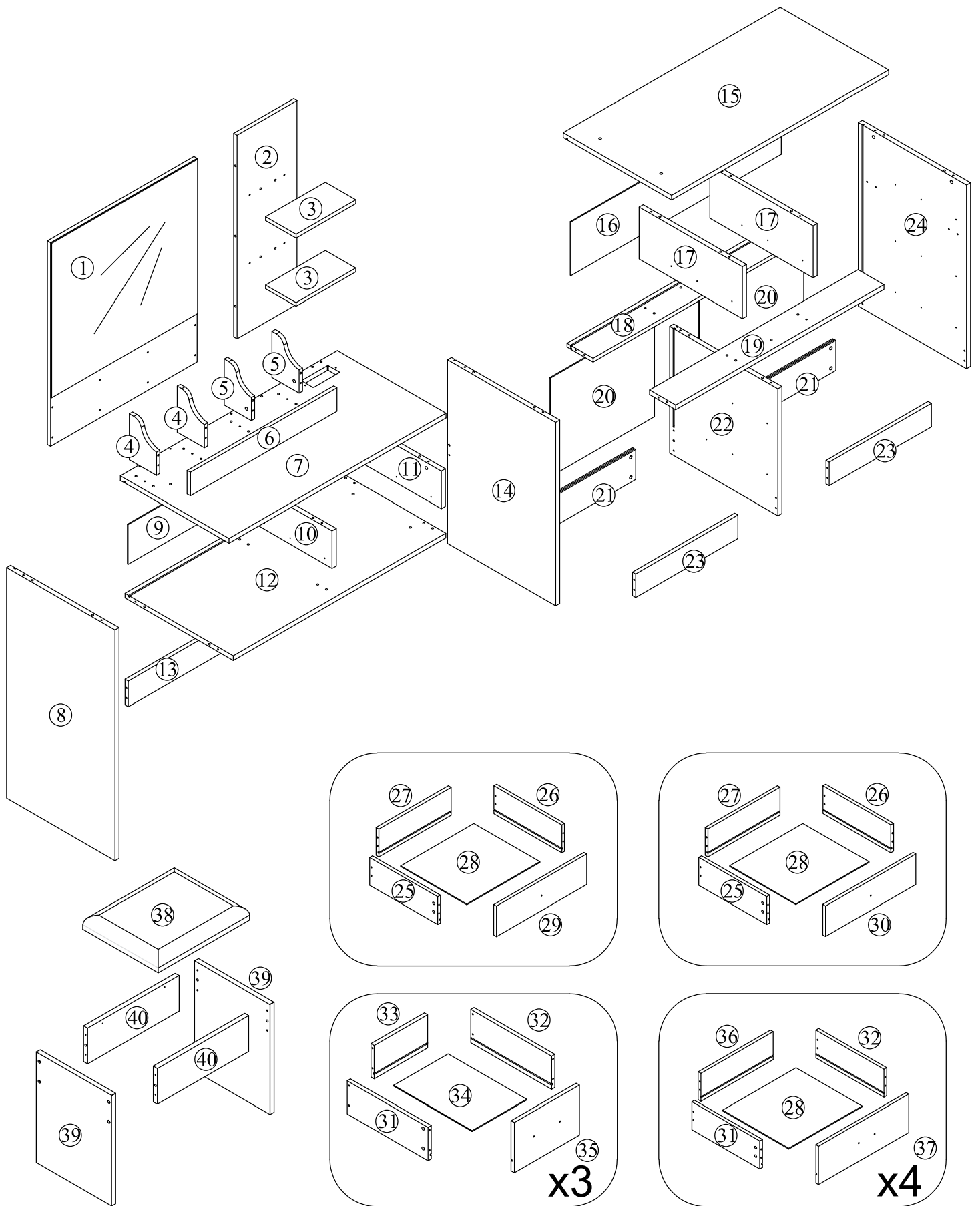

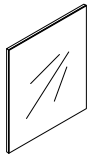





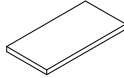

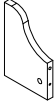
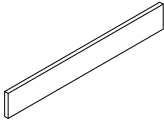
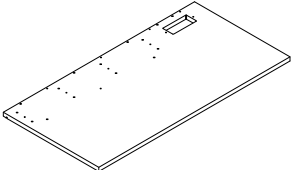

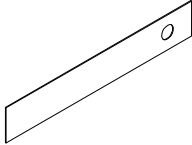
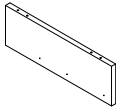
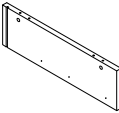
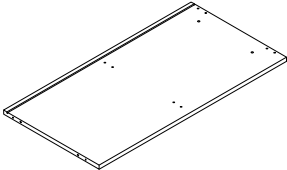
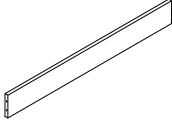
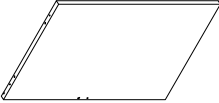
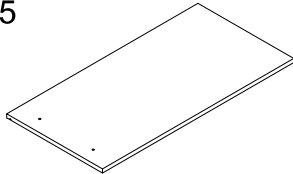
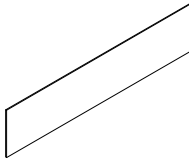
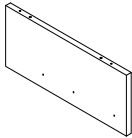
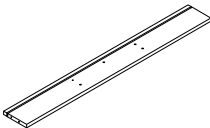
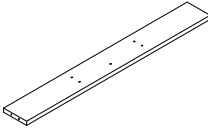
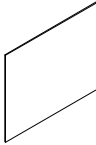
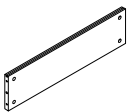
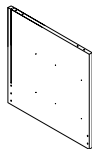
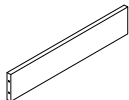
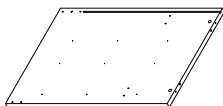
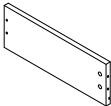
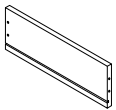
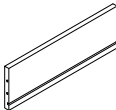
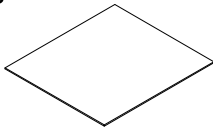
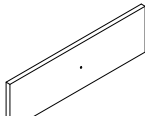
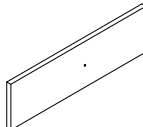
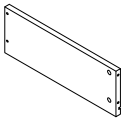
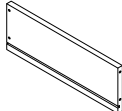

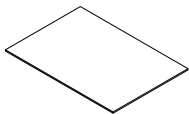
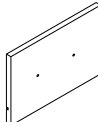
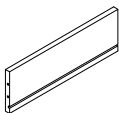
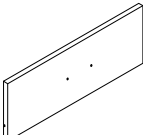
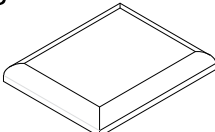
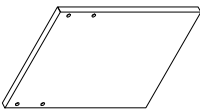
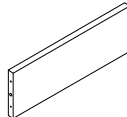
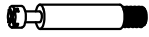





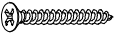
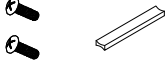



Assembly Instruction

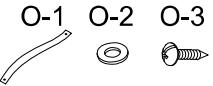

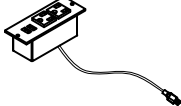

1  649x539x12 x1	2  649x220x12 x1	3  219x112x12 x2	4  146x100x12 x2	
5  146x100x12 x2	6  539x74x12 x1	7  799x399x15 x1	8  735x398x15 x1	
9  774x127 x1	10  120x367x15 x1	11  120x397x15 x1	12  783x398x15 x1	
13  685x79x12 x1	14  585x398x15 x1	15  799x399x15 x1	16  774x173 x1	
17  166x380x15 x2	18  768x95x15 x1	19  768x95x15 x1	20  384x316 x2	
21  376x95x12 x2	22  404x398x15 x1	23  376x74x12 x2	24  585x398x15 x1	25  298x85x12 x2
26  298x85x12 x2	27  327x85x12 x2	28  335x292 x6	29  378x114x12 x1	30  378x114x12 x1
31  298x105x12 x7	32  298x105x12 x7	33  197x105x12 x3	34  204x292 x3	35  239x159x12 x3
36  327x105x12 x4	37  369x159x12 x4	38  398x297x40 x1	39  398x296x15 x2	40  367x115x15 x2

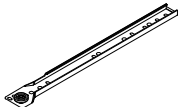
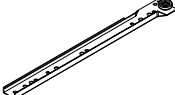
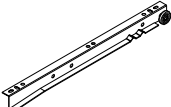
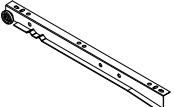
<p>A x 84+5</p>  <p>Φ6X35mm</p>	<p>B x 84+5</p>  <p>Φ15X10mm</p>	<p>C x 58+5</p>  <p>Φ6X30mm</p>	<p>D x 63+3</p>  <p>Φ4X35mm</p>	<p>E x 110+10</p>  <p>Φ3X12mm</p>
<p>F x 8+1</p>  <p>Φ4X12mm</p>	<p>G x 12+2</p>  <p>Φ5X40mm</p>	<p>H x 7+2</p> <p>H-1 H-2</p>  <p>Φ4X16mm</p>	<p>I x 1</p>  <p>Φ6X50mm</p>	<p>J x 12+1</p> 
<p>K x 2</p> <p>K-1 K-2</p>  <p>Φ4X16mm</p>	<p>L x 12+1</p>  <p>Φ21</p>	<p>M x 4</p> 	<p>N x 16+2</p> <p>N-1 N-2</p>  <p>Φ3X16mm</p>	<p>O x 2</p> <p>O-1 O-2 O-3</p>  <p>Φ4X12mm</p>
<p>P x 2</p> <p>P-1 P-2 P-3</p>  <p>Φ4X45mm</p>	<p>Q x 1</p> 	<p>R x 1</p> 	<p>S x 1</p> <p>S-1 S-2</p> 	
<p>T x 2</p> <p>T-1 T-2</p>  <p>Φ6X25mm</p>	<p>U x 4</p>  <p>Φ3X10mm</p>	<p>CL x 9</p>  <p>L300</p>	<p>CR x 9</p>  <p>L300</p>	<p>DL x 9</p>  <p>L300</p>
<p>DR x 9</p>  <p>L300</p>				

1

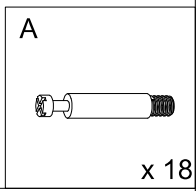
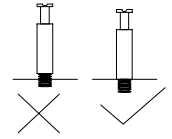
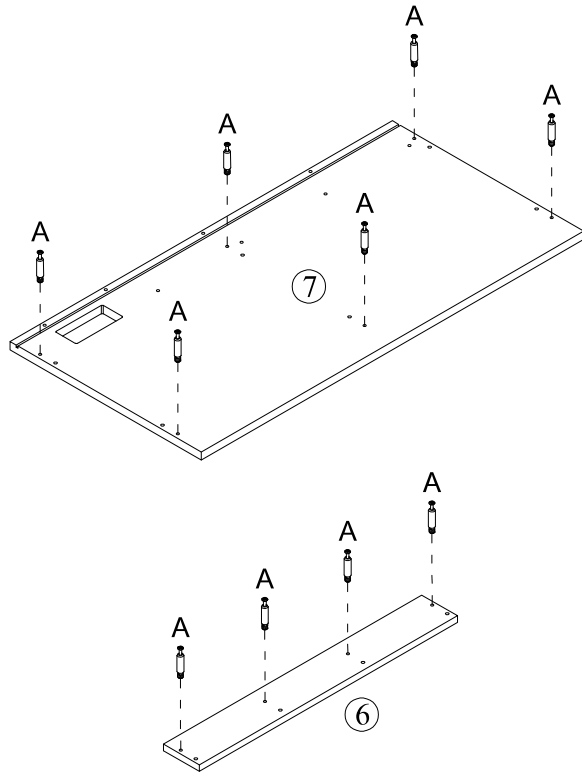

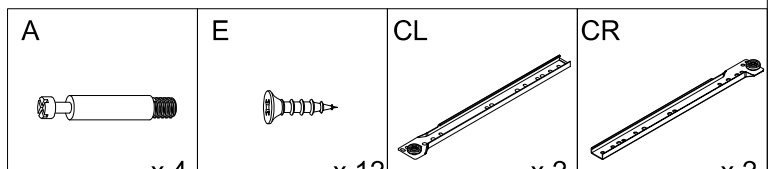
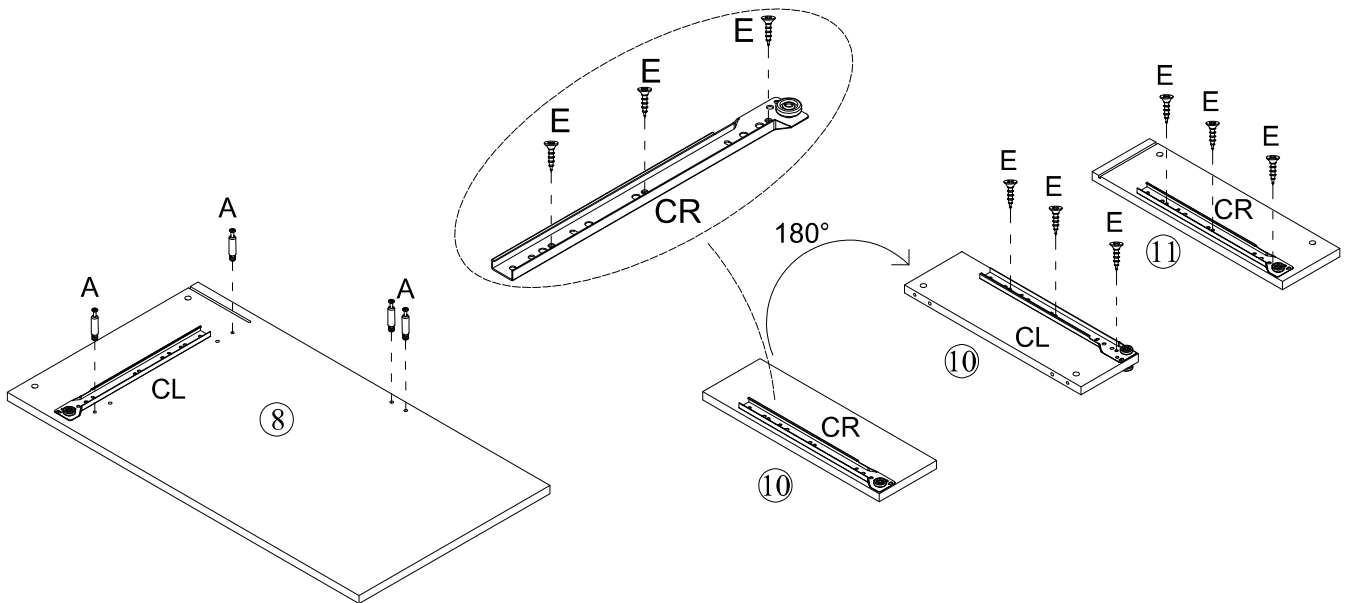

2



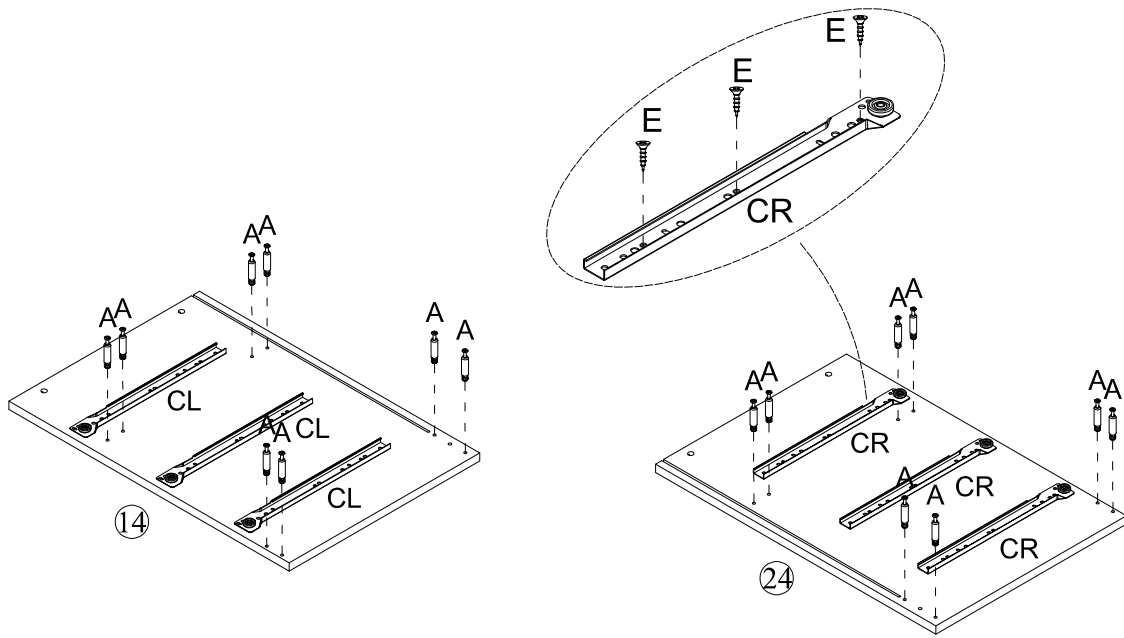

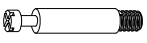
3

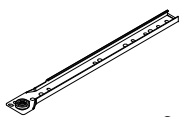
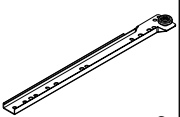

<p>A</p>  <p>x 16</p>	<p>E</p>  <p>x 18</p>	<p>CL</p>  <p>x 3</p>	<p>CR</p>  <p>x 3</p>
---	---	---	---

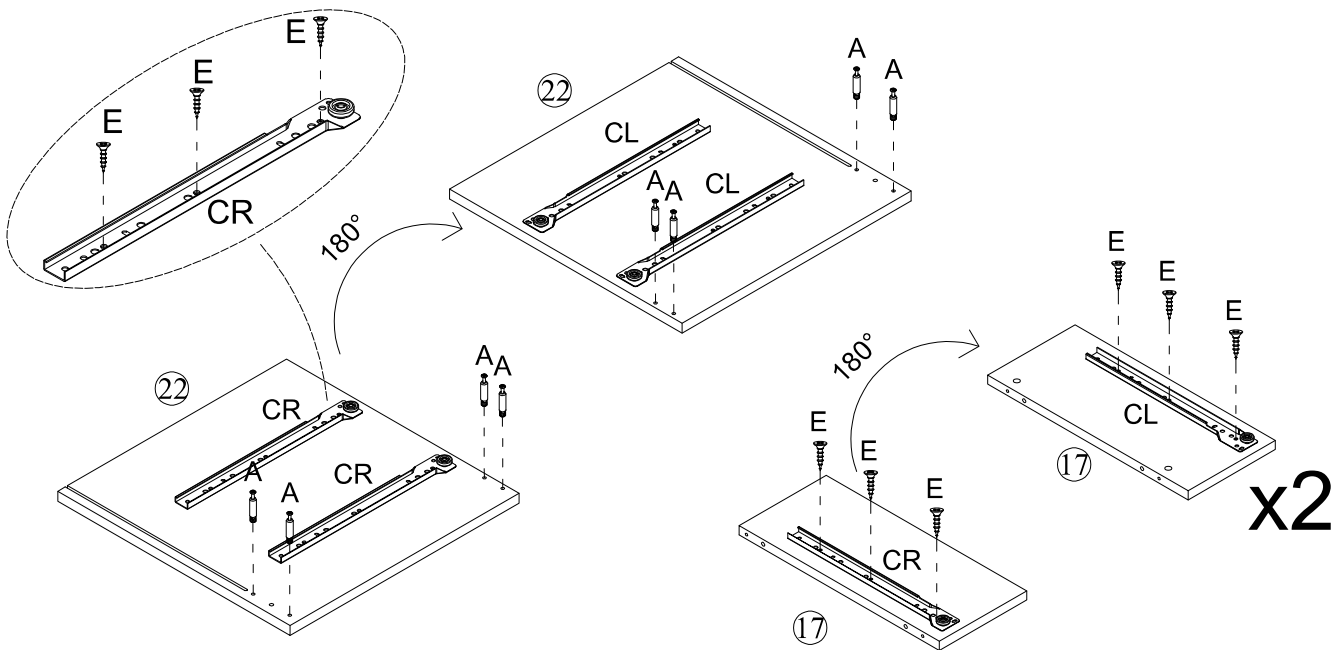

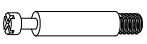
4

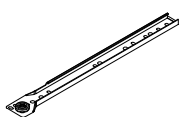
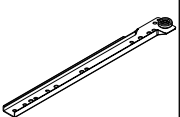

<p>A</p>  <p>x 8</p>	<p>E</p>  <p>x 24</p>	<p>CL</p>  <p>x 4</p>	<p>CR</p>  <p>x 4</p>
---	--	--	--

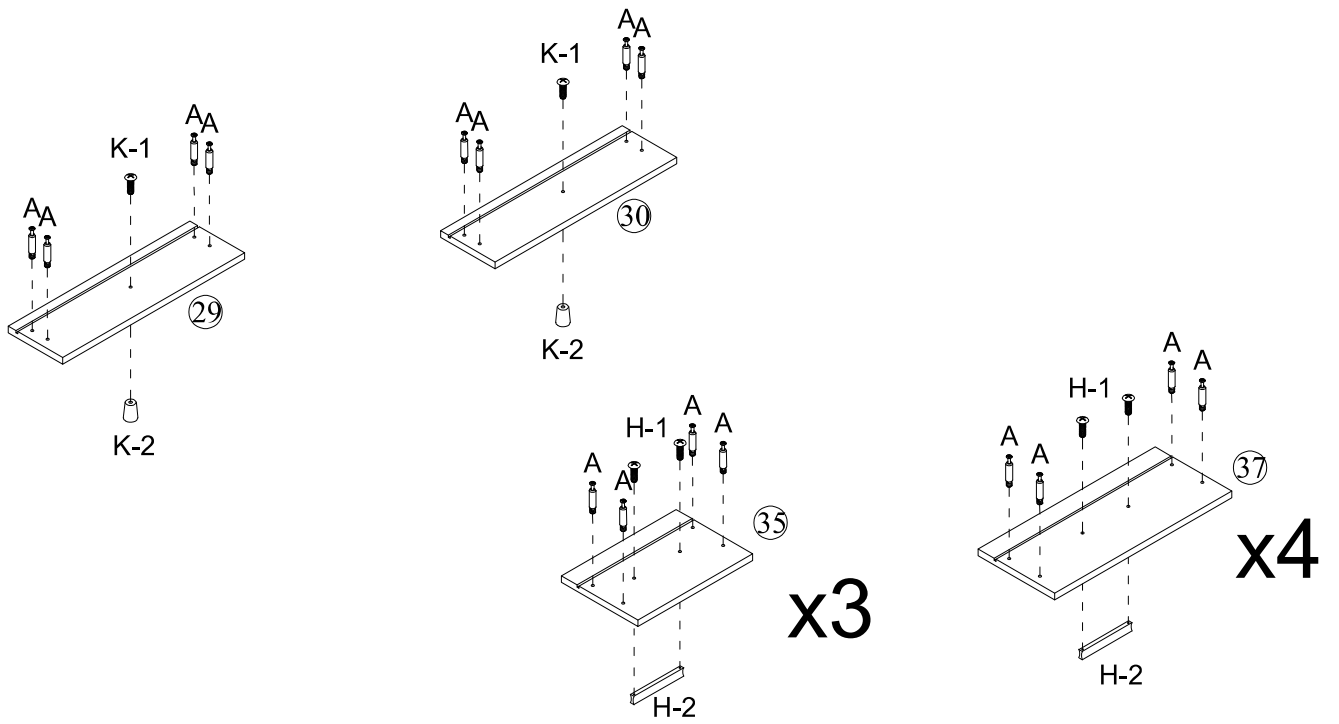
5

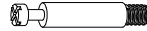
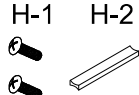

<p>A</p>  <p>x 36</p>	<p>H</p> <p>H-1 H-2</p>  <p>x 7</p>	<p>K</p> <p>K-1 K-2</p>  <p>x 2</p>
--	---	--

6

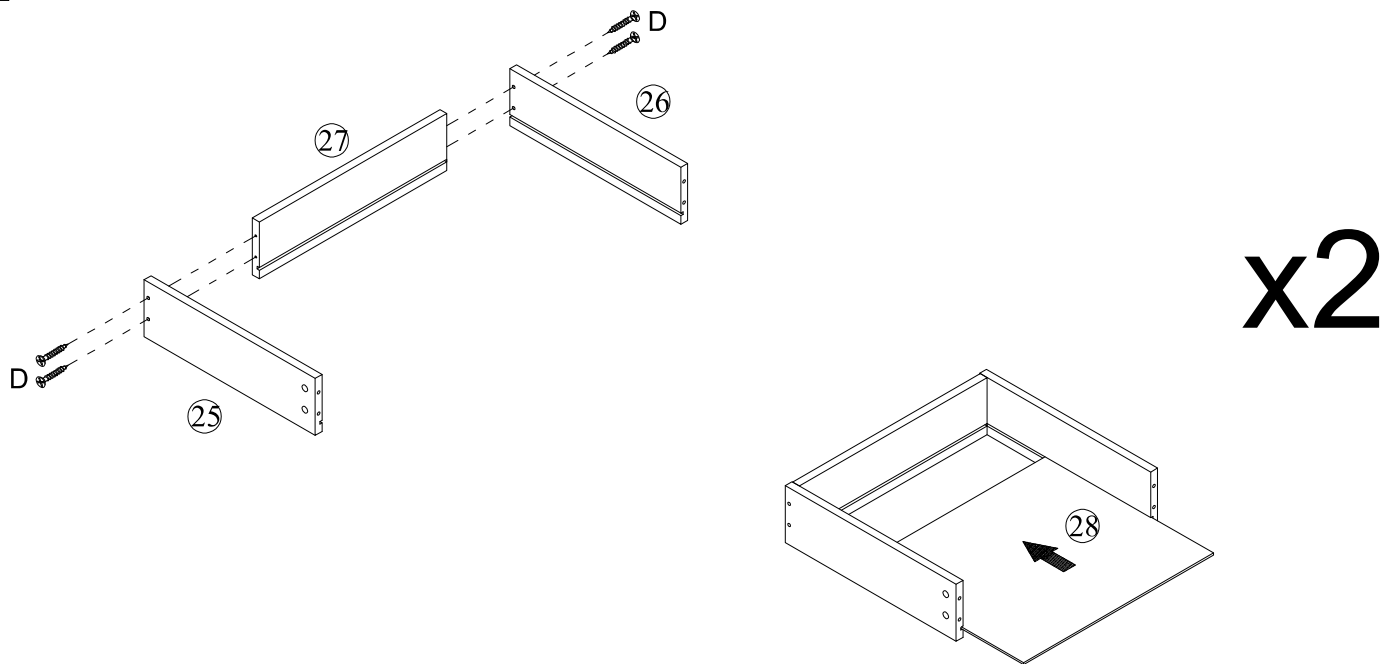

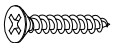

<p>D</p>  <p>x 8</p>

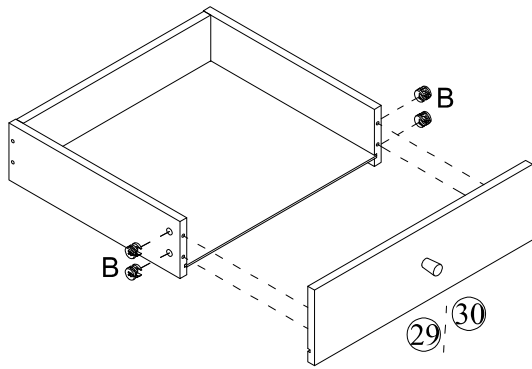
7

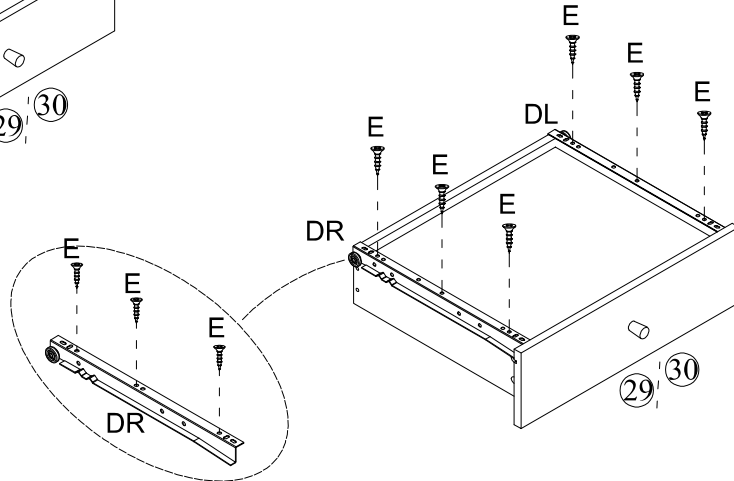

x2

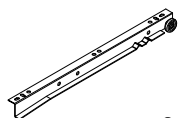
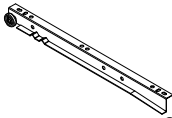

<p>B</p>  <p>x 8</p>	<p>E</p>  <p>x 12</p>	<p>DL</p>  <p>x 2</p>	<p>DR</p>  <p>x 2</p>
--	---	---	---

8

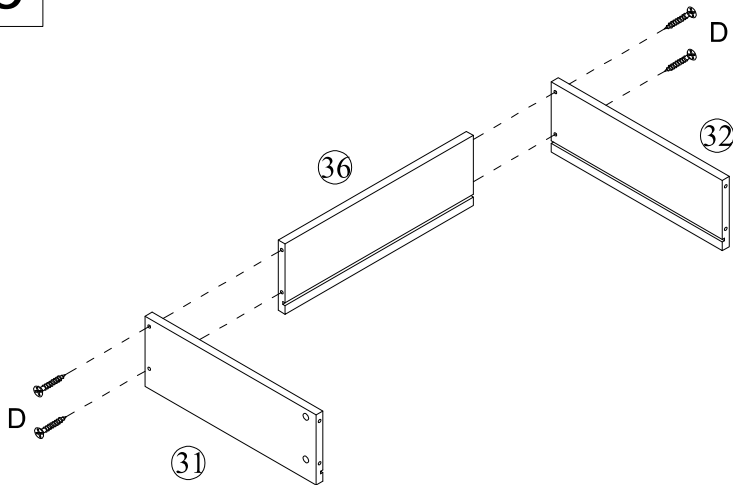

x4

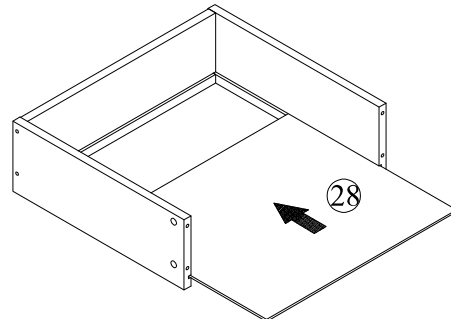

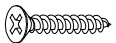

<p>D</p>  <p>x 16</p>
--

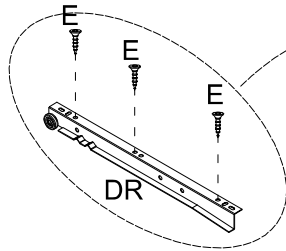
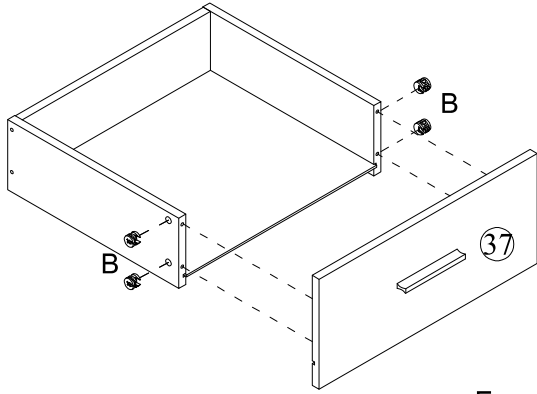
9

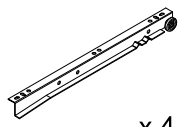
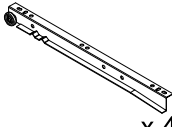

x4

<p>B</p>  <p>x16</p>	<p>E</p>  <p>x24</p>	<p>DL</p>  <p>x4</p>	<p>DR</p>  <p>x4</p>
--	--	--	--

10

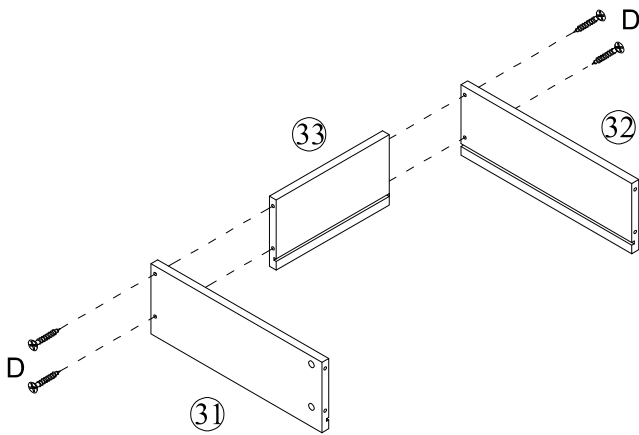

x3

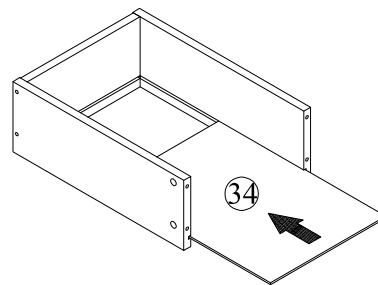

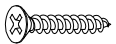

<p>D</p>  <p>x12</p>

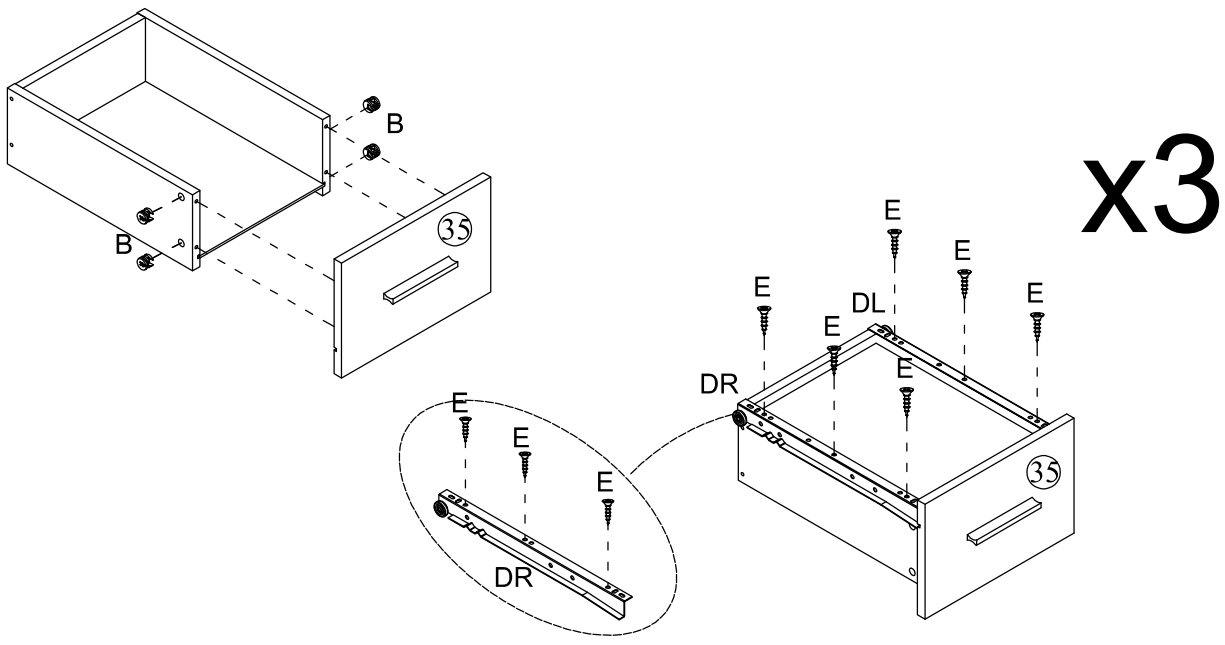
11



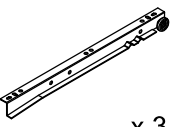
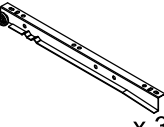

x3

<p>B</p>  <p>x12</p>	<p>E</p>  <p>x18</p>	<p>DL</p>  <p>x3</p>	<p>DR</p>  <p>x3</p>
--	--	--	--

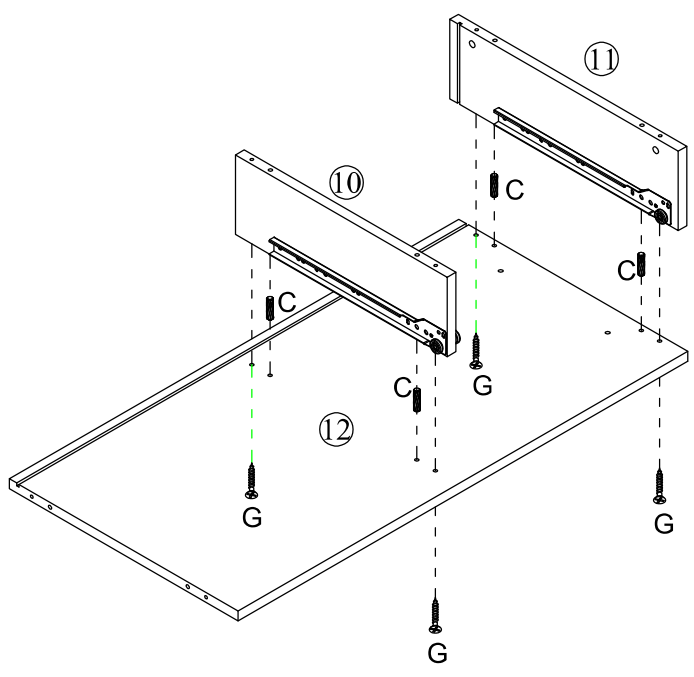

12



<p>C</p>  <p>x4</p>	<p>G</p>  <p>x4</p>
--	--

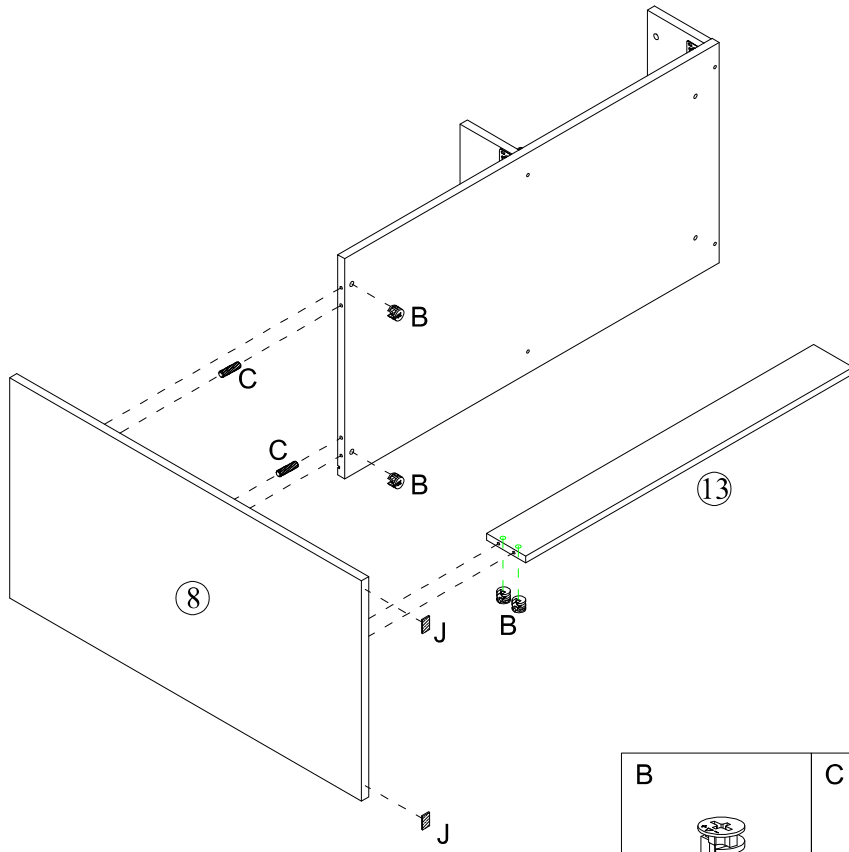

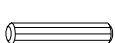
13

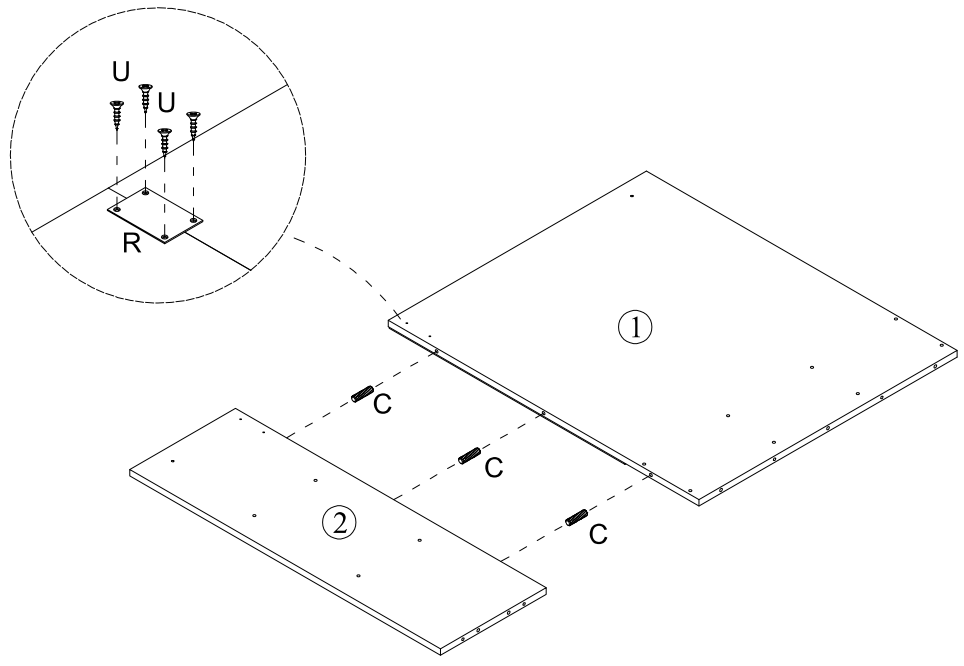

B	C	J
		
x 4	x 2	x 2

14

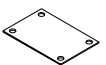

C	R	U
		
x 2	x 1	x 4

15

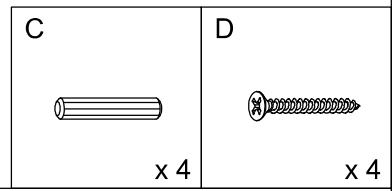
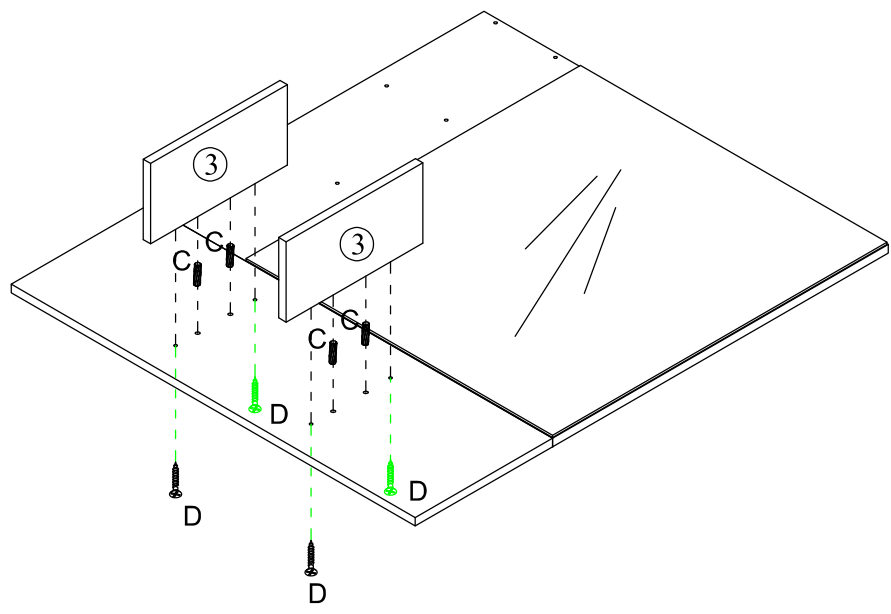

16

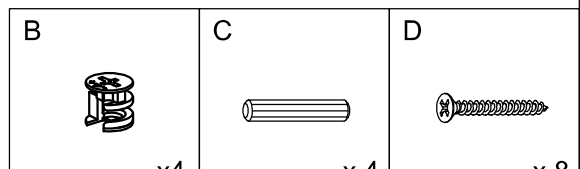
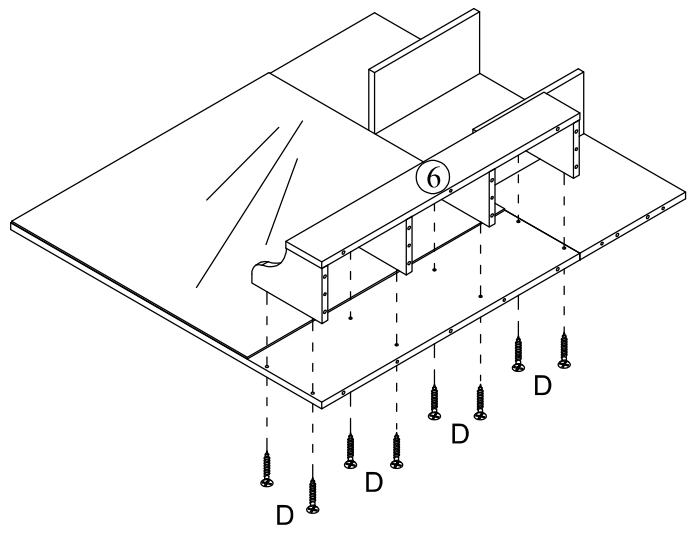
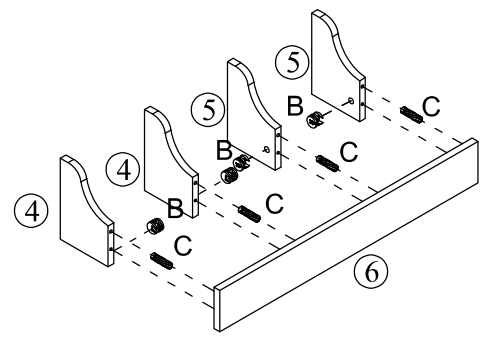

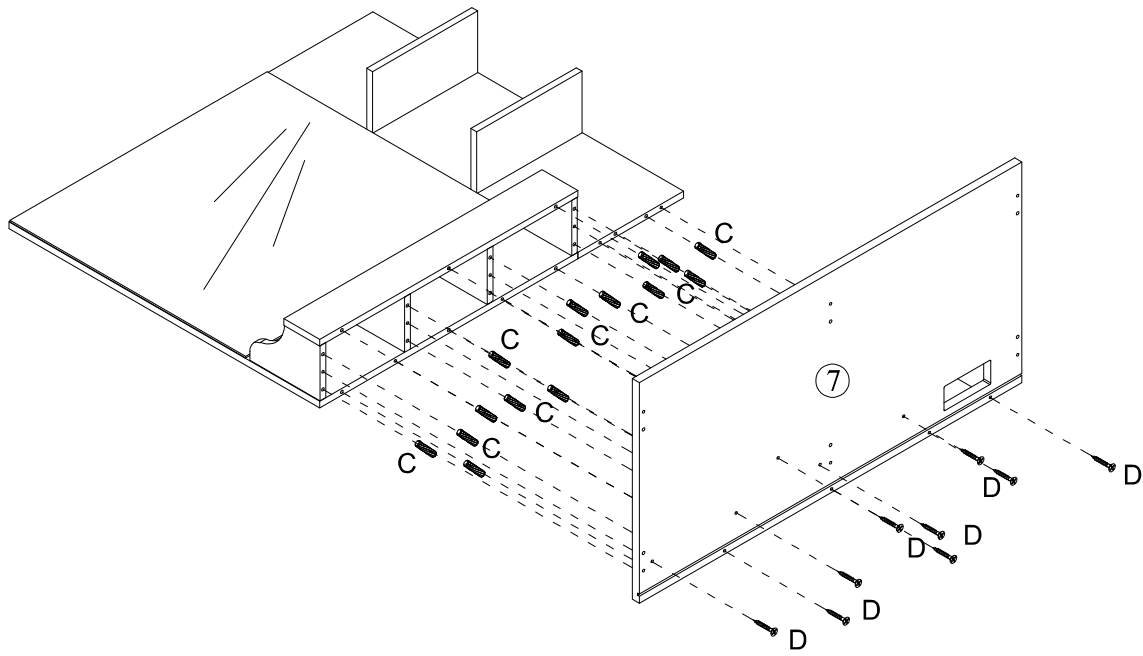

17

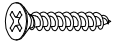

C	D
	
x 15	x 9

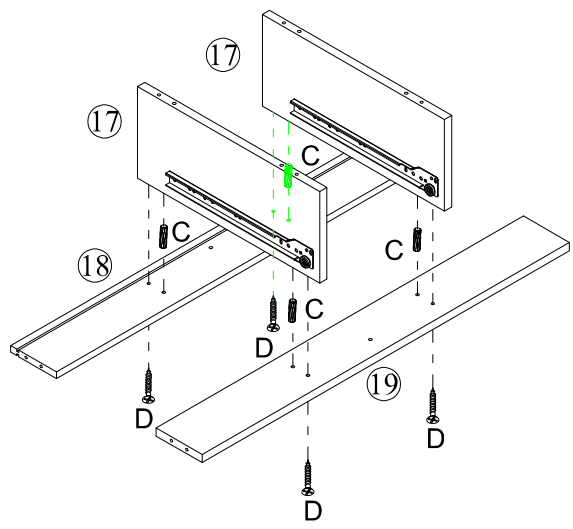
18

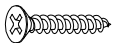

C	D
	
x 4	x 4

19

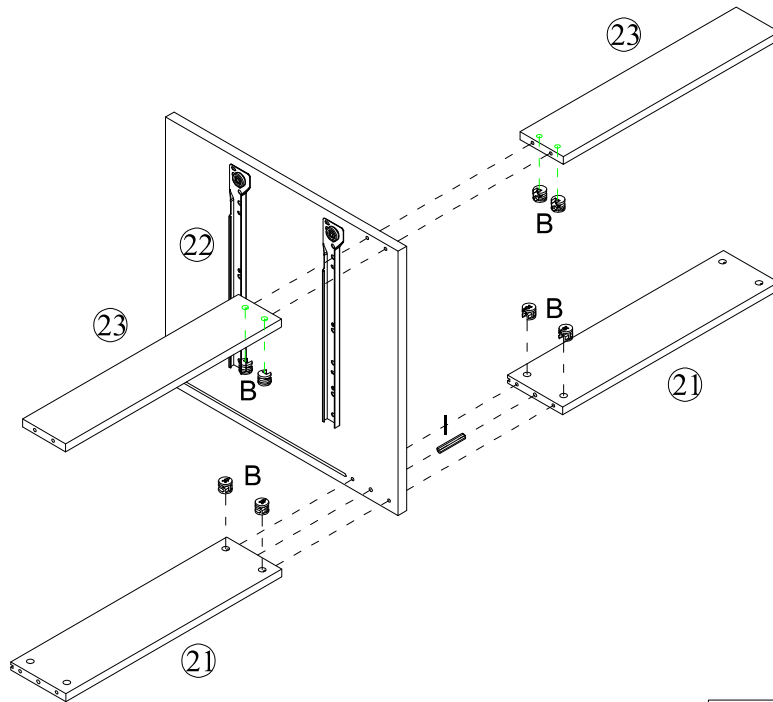

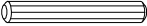
B  x 8	I  x 1
--	--

20

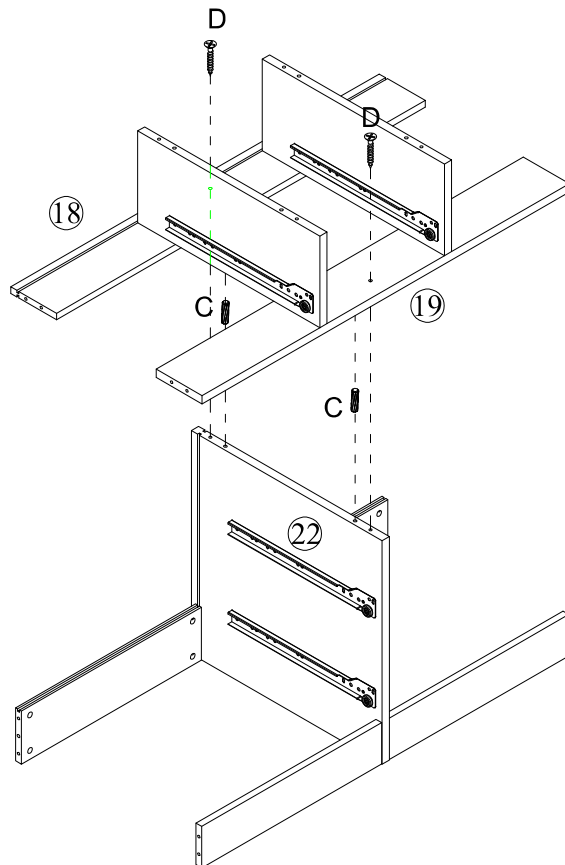

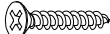

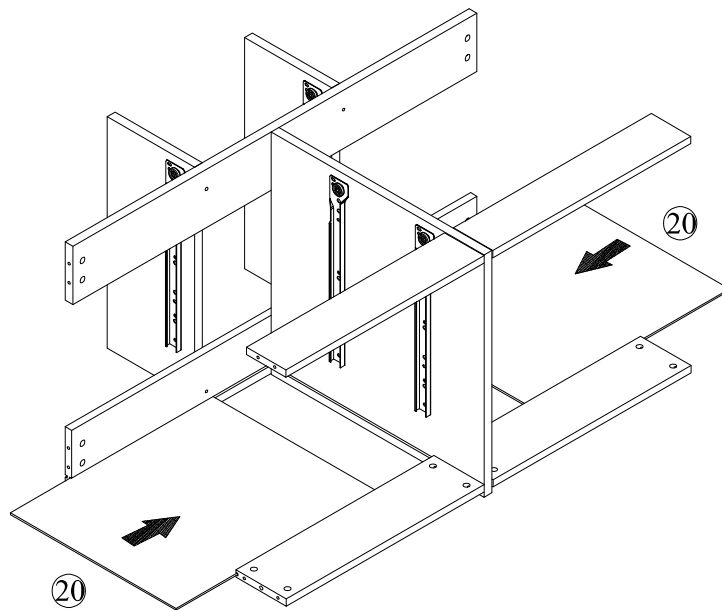

C  x 2	D  x 2
---	---

21

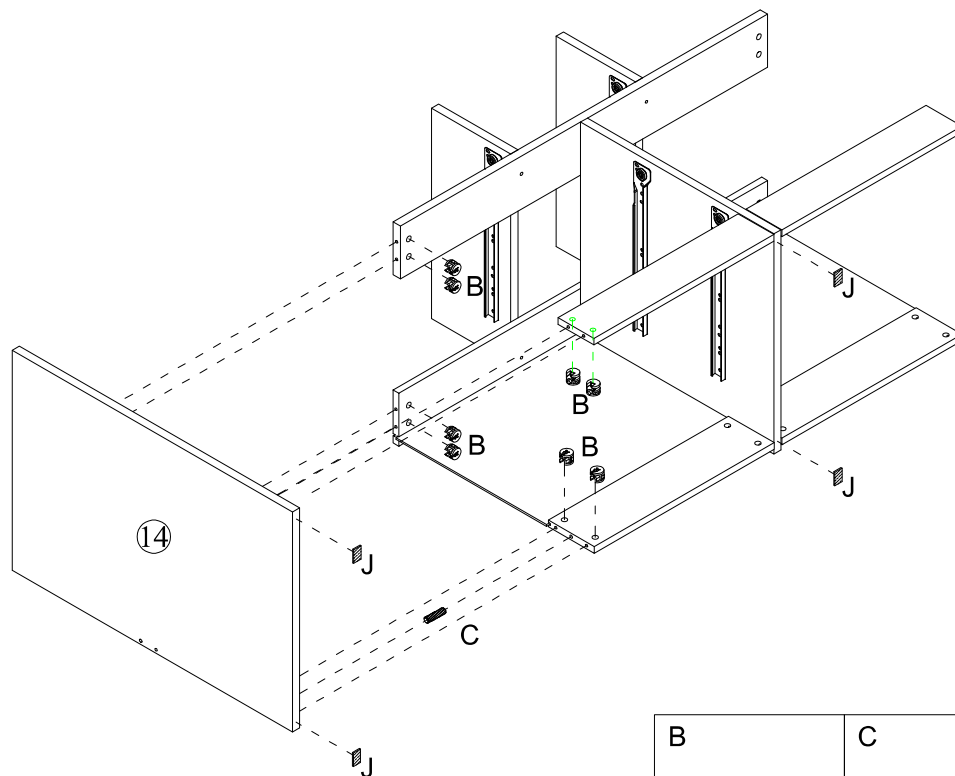



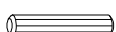

22

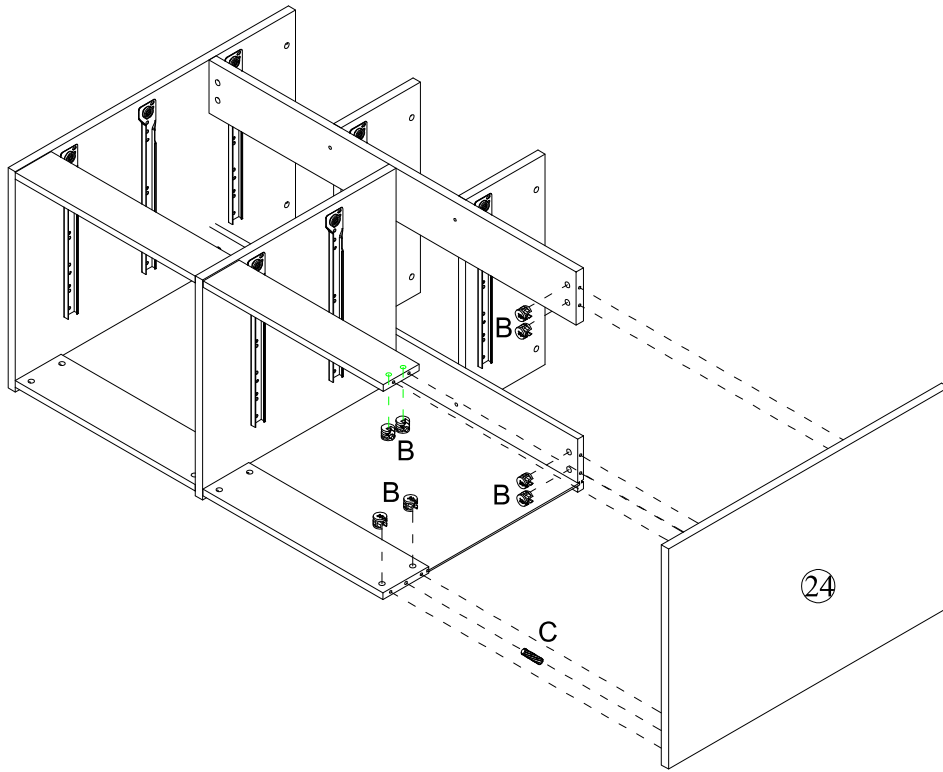

B	C	J
		
x 8	x 1	x 4

23

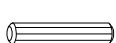



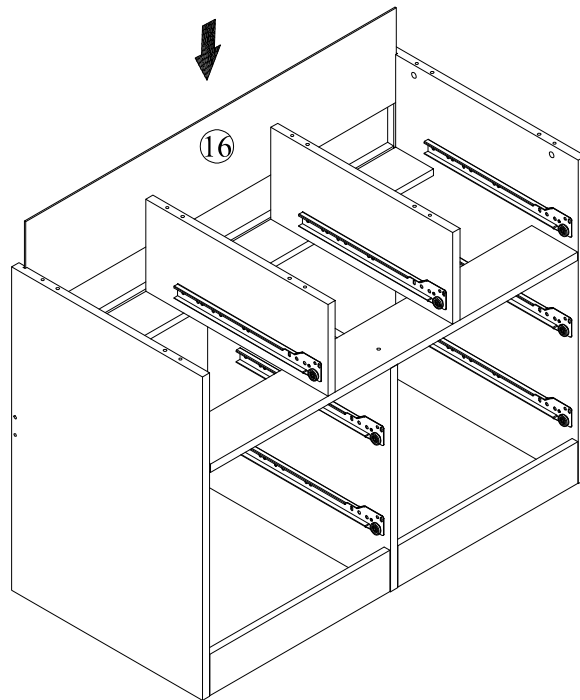

B  x 8	C  x 1	J  x 1
--	--	--

24

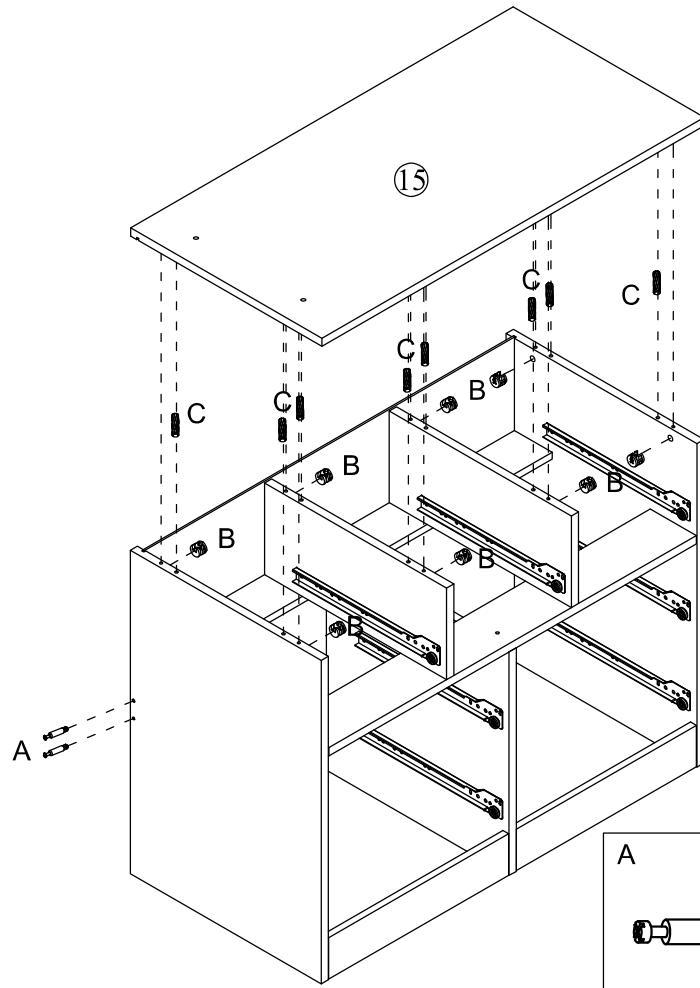



25



A  x 2	B  x 8	C  x 8
---	--	---

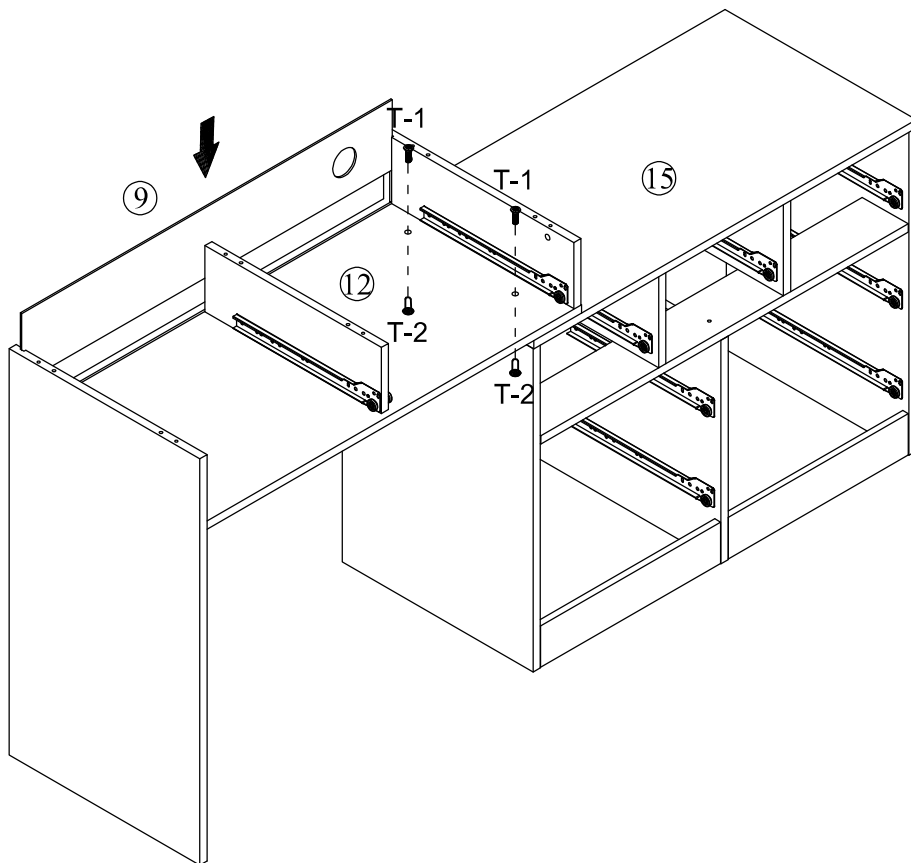

26

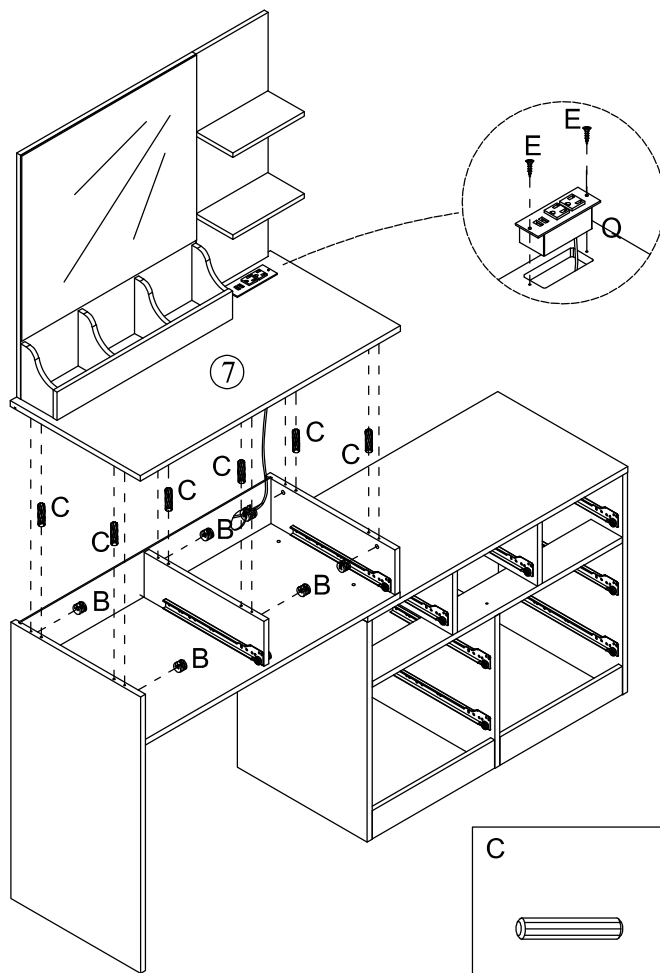

T T-1  T-2  x 2
--

27

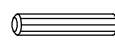

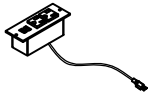



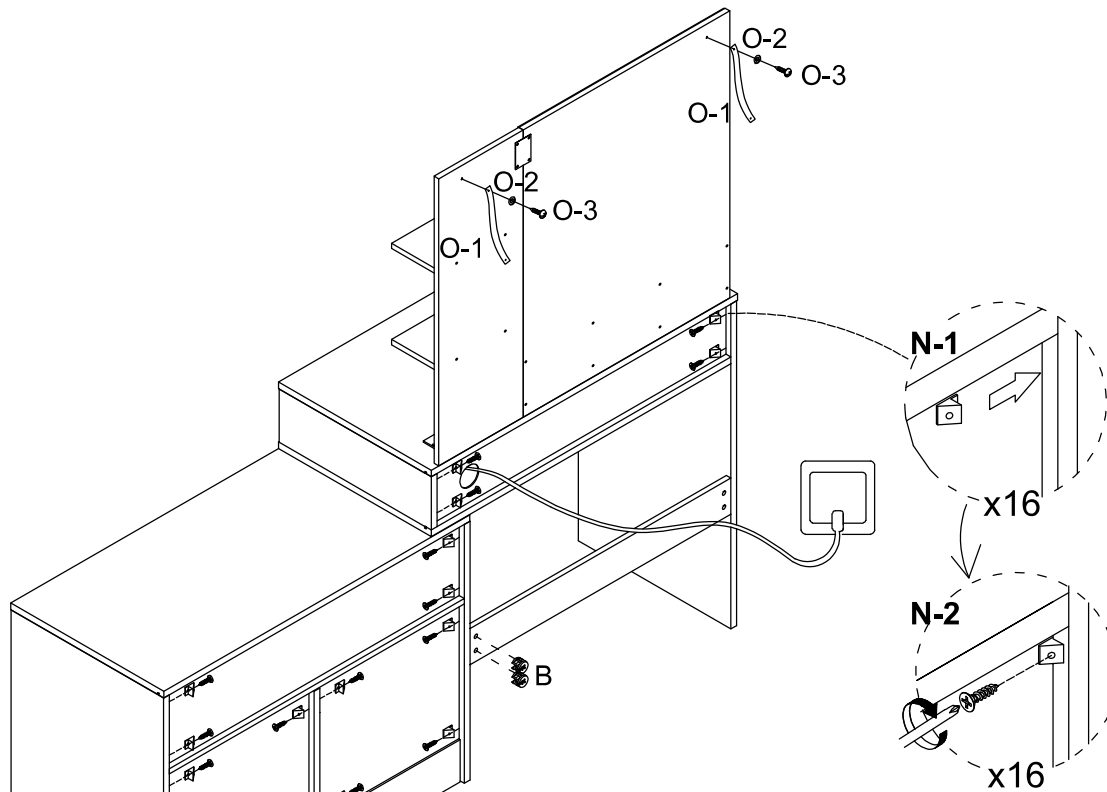

<p>C</p>  <p>x 6</p>	<p>E</p>  <p>x 2</p>	<p>Q</p>  <p>x 1</p>
--	--	--

<p>B</p>  <p>x 6</p>

28



<p>B</p>  <p>x 2</p>	<p>N</p> <p>N-1</p>  <p>N-2</p>  <p>x 16</p>	<p>O</p> <p>O-1</p>  <p>O-2</p>  <p>O-3</p>  <p>x 2</p>
---	--	--

29

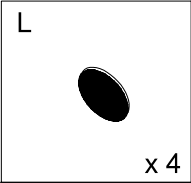
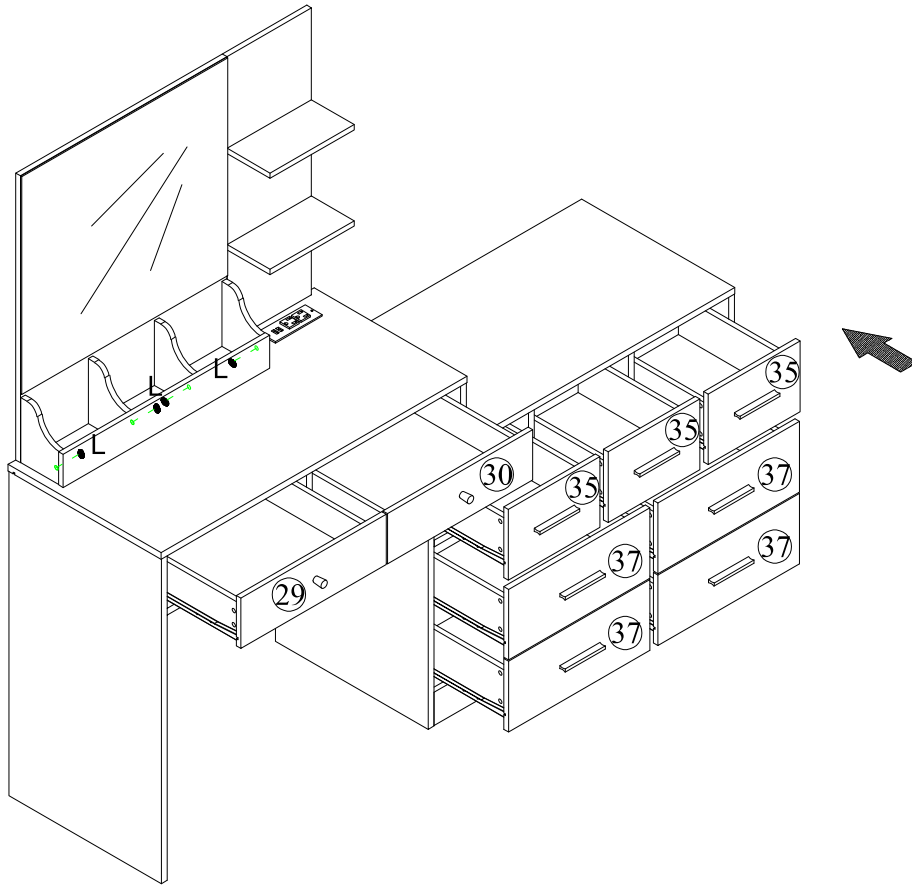

30

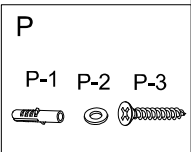
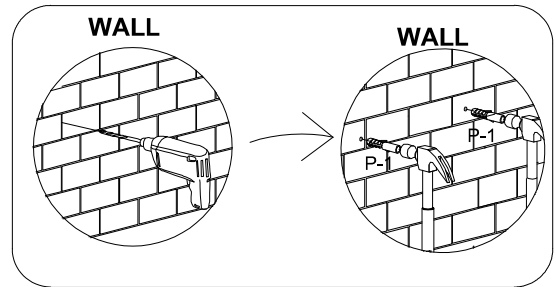
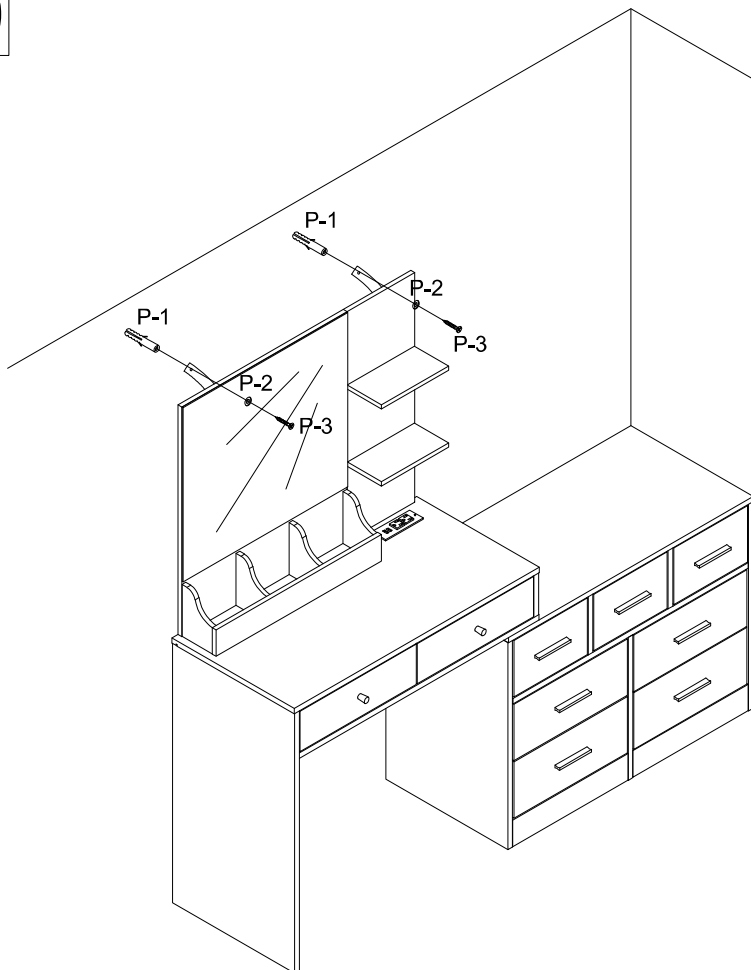

31

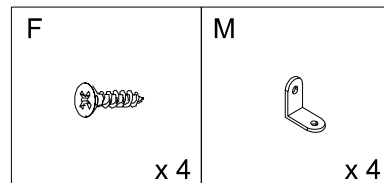
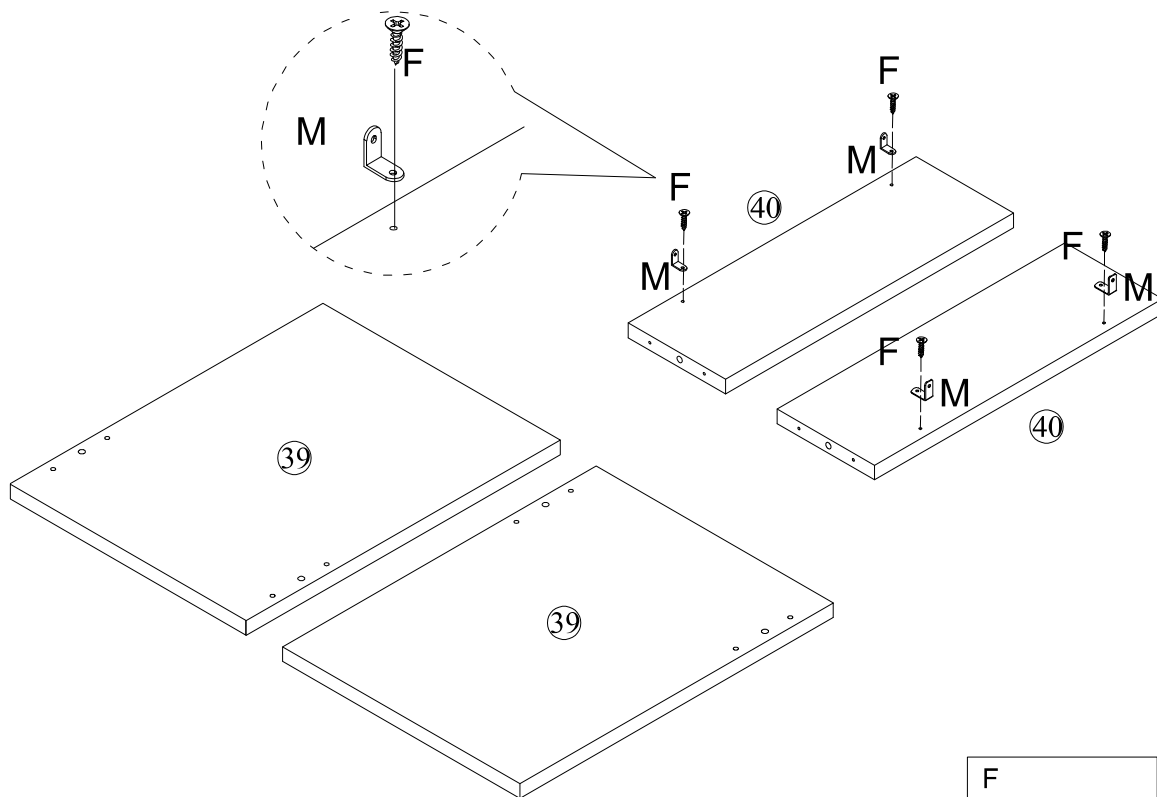

32

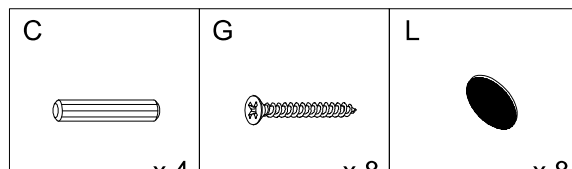
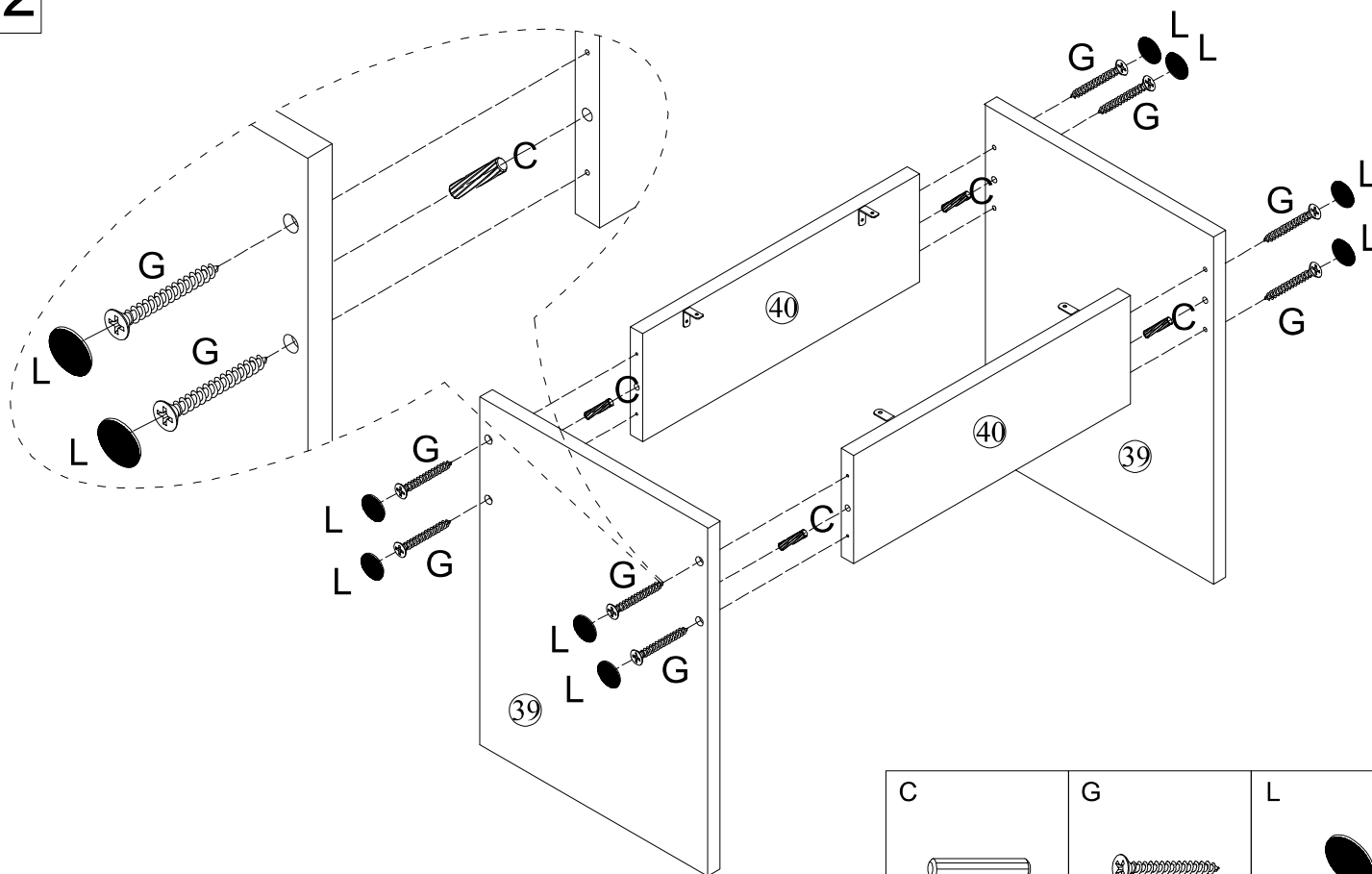

33

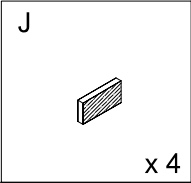
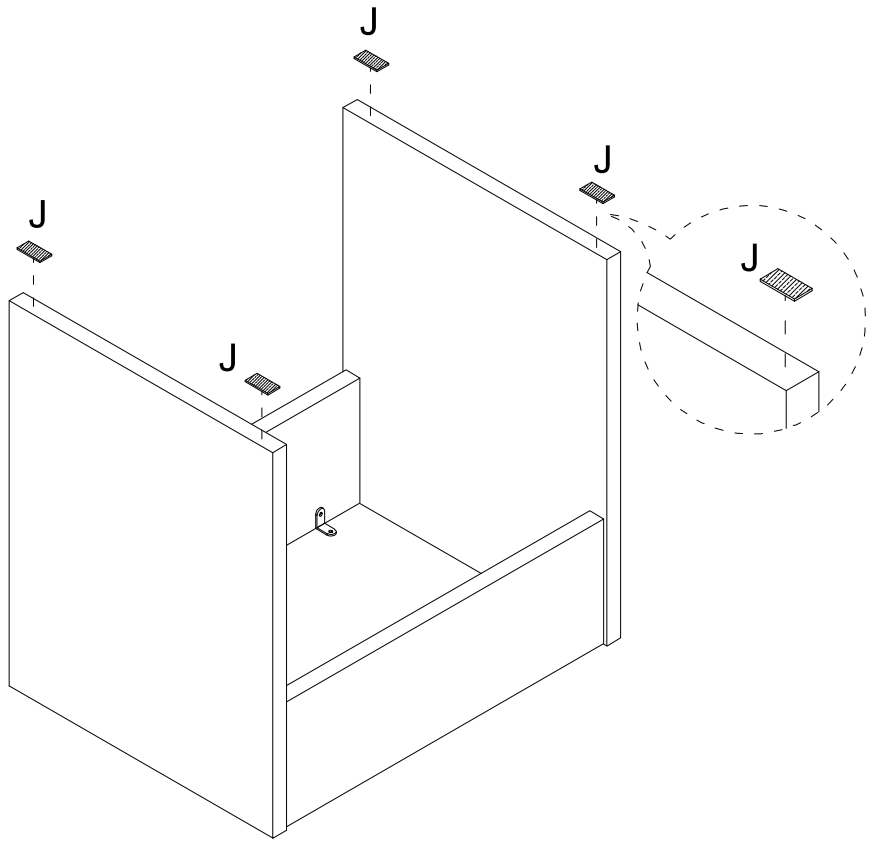

34

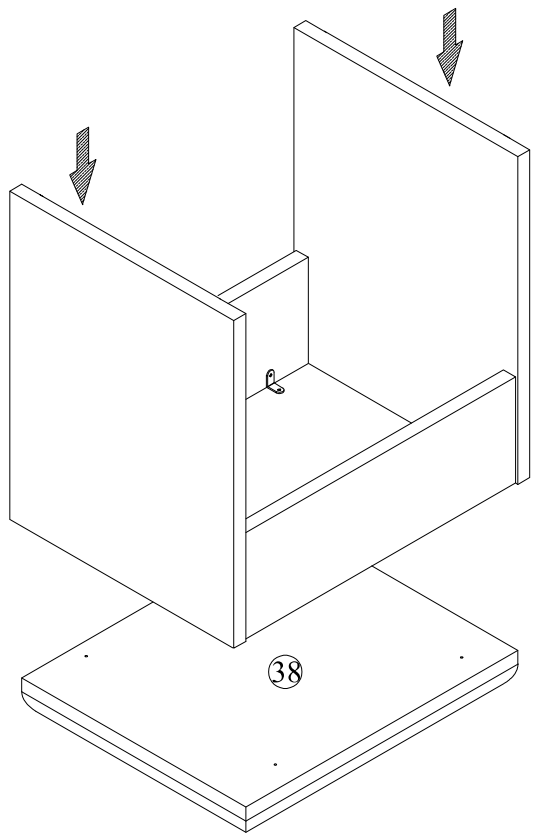

35

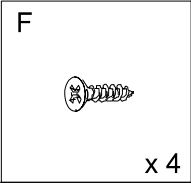
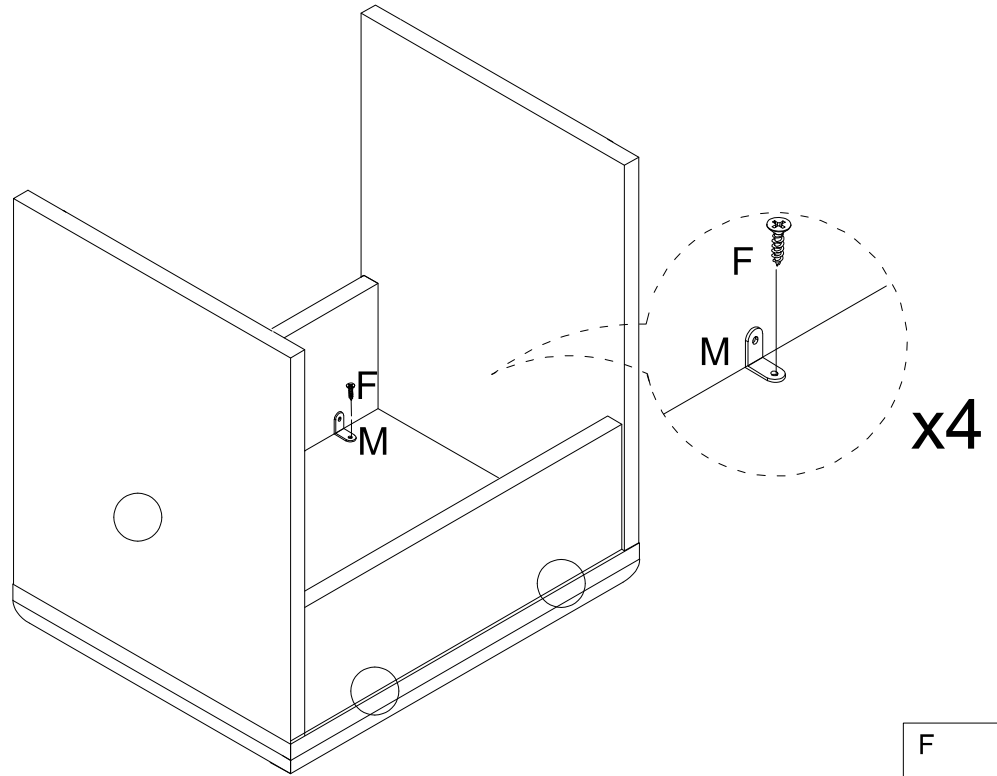

36

