

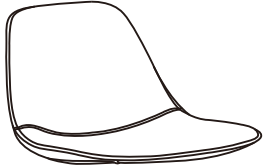
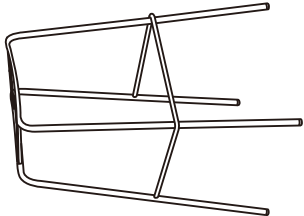

ASSEMBLY INSTRUCTION

A X1	
B X1	
C X4	
D X1	