

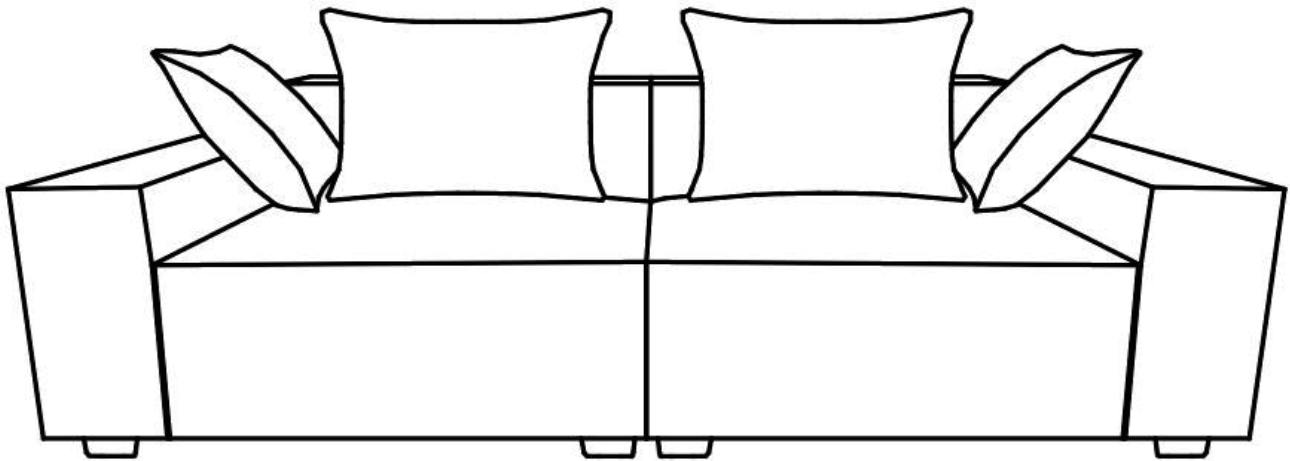

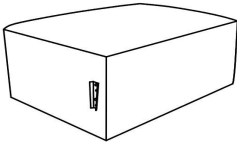

ASSEMBLY INSTRUCTIONS

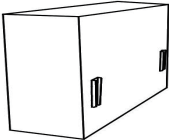
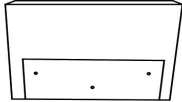
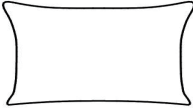
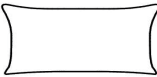
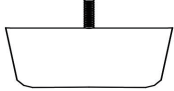

S
P
A
R
E

P
A
R
T
S

 A*2	 B*2	 C*2
 D*2	 E*2	 F*8
 G*6	 H*6	 I*1
 J*16	<p>Note: The back pillows D and E are stored in the two armrests respectively.</p>	

Part 1: Pillow D*1, pillow E*1, armrest*1, base frame*1, wooden legs*4, hardware bag

Part 2: Pillow D*1, pillow E*1, armrest*1, base frame*1, wooden legs*4, hardware bag

Part 3: Backrest*2

Installation Steps

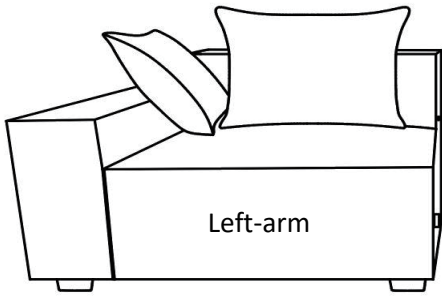

A*1-L



B*1-L

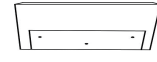

C*1-L



F*4



G*3



H*3



I*1



J*8

STEP1

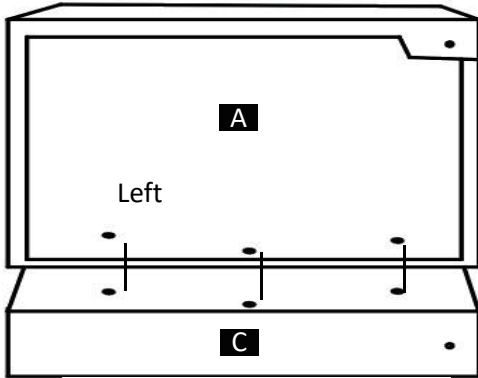

Line up the pre-drilled holes.

STEP2

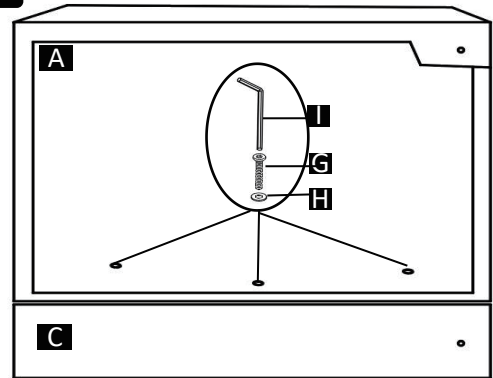

Connect the base and backrest.

STEP3

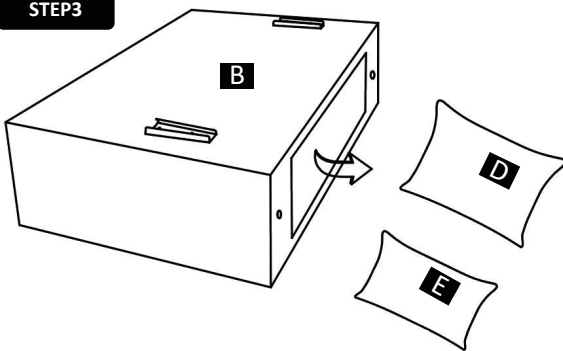

Take the pillows from the armrest.

STEP4

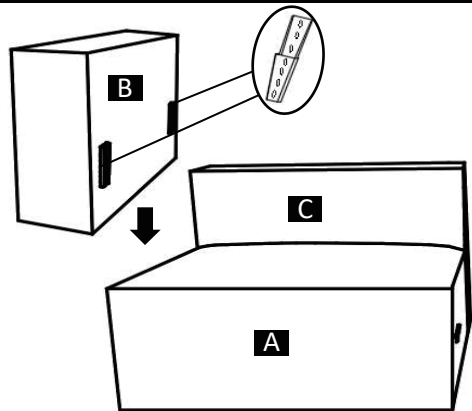

Attach the armrest using brackets.

STEP5

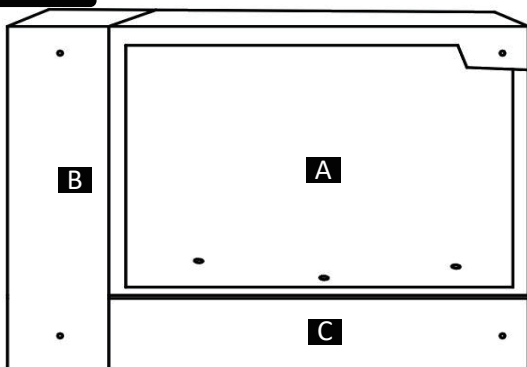

STEP6

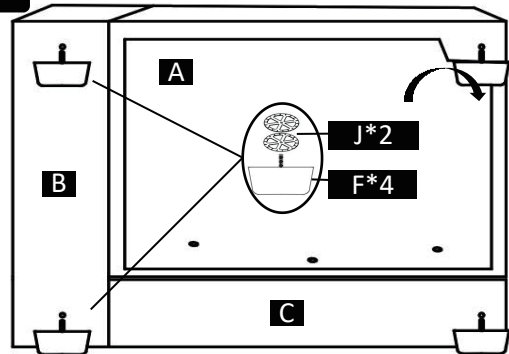

Install four legs.

Installation Steps

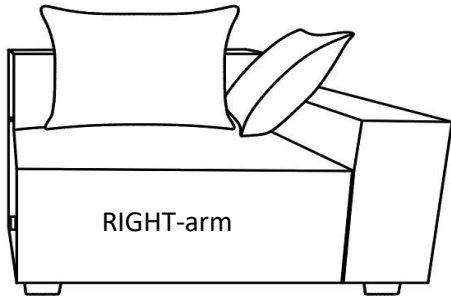

A*1-R



B*1-R

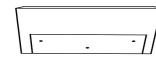

C*1-R

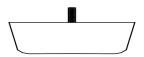

F*4



G*3



H*3



I*1



J*8

STEP1

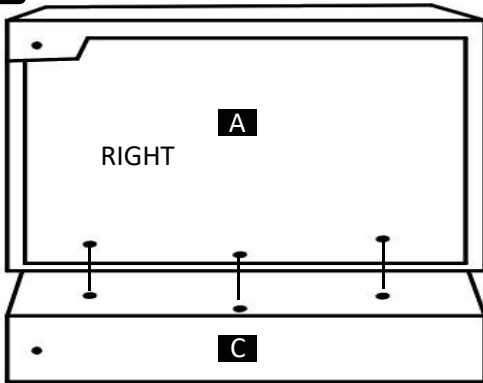

Line up the pre-drilled holes.

STEP2

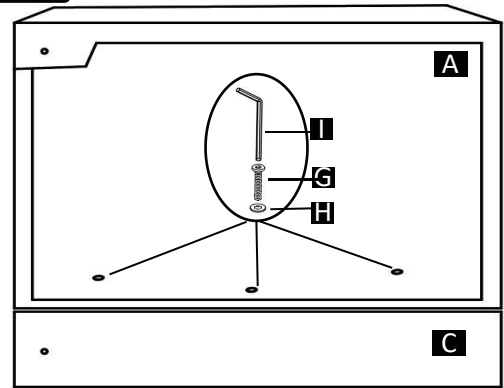

Connect the base and backrest.

STEP3

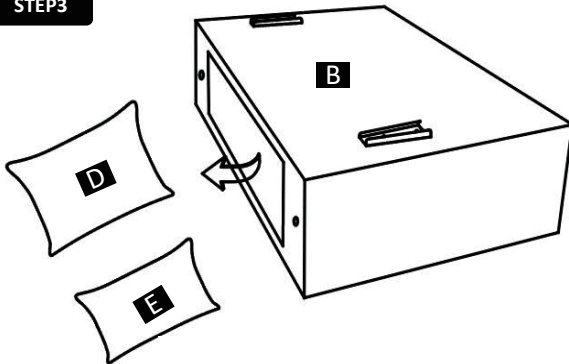

Take the pillows from the armrest.

STEP4

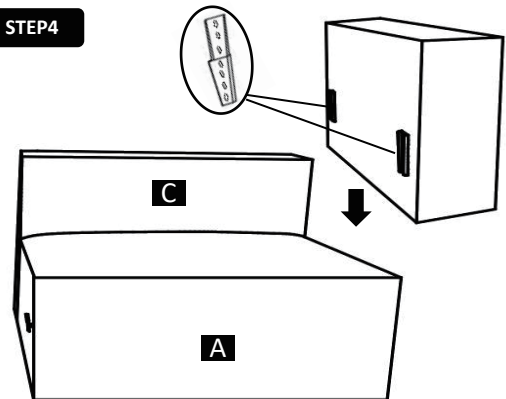

Attach the armrest using brackets.

STEP5

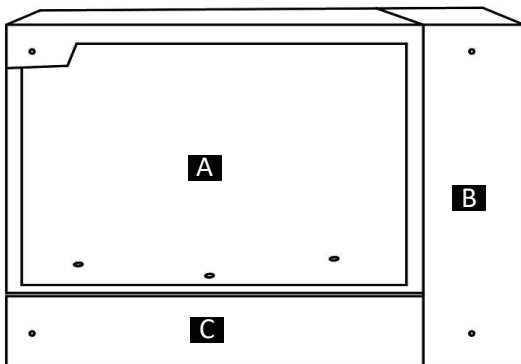

STEP6

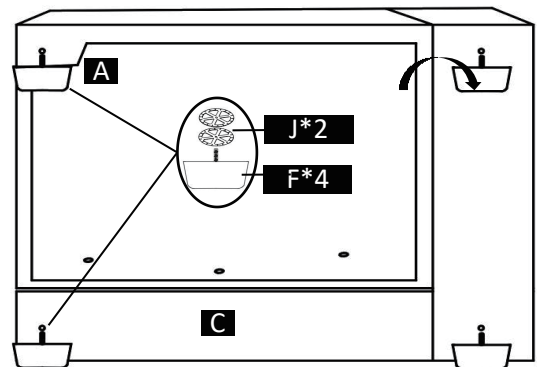

Install four legs.

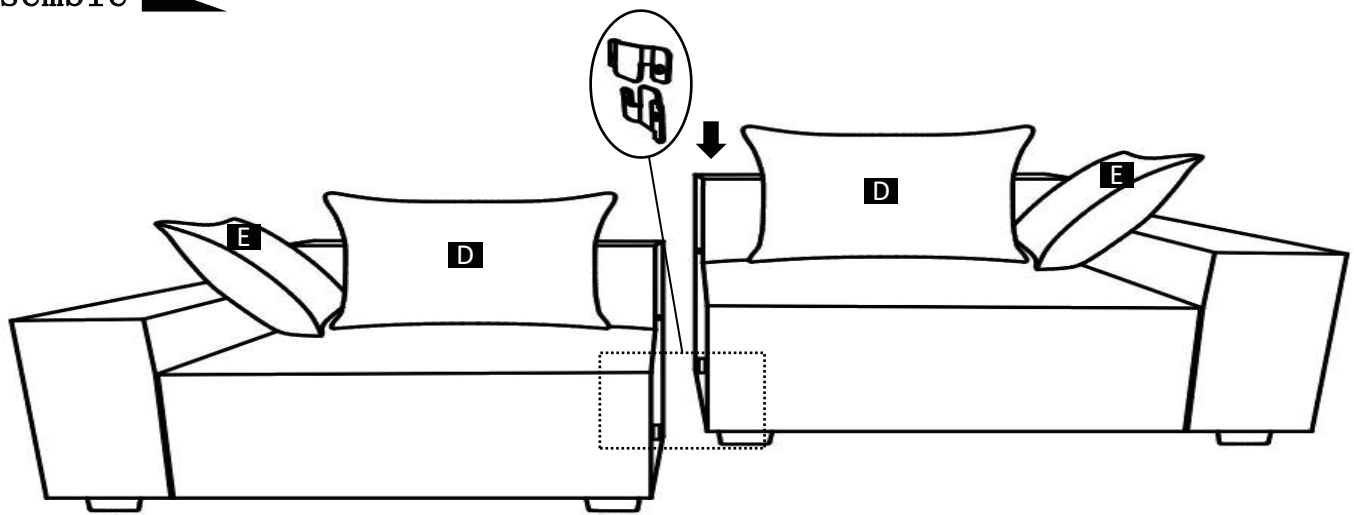

Insert into a slot to hold it in place.

Frequently Asked Questions

1: What should I do if my shipment is damaged or products received are defective?

We're sorry to hear that! Please message us and provide a detailed description of the damage, as well as photos (or videos, where appropriate) showing the damage. We will do our best to resolve the issue as soon as possible.

2: Could I return the product if I'm not satisfied?

We put quality as one of our top priorities – We work with experienced manufacturers and have every piece of our product going through strict quality control process. However, if you still unsatisfied, it is recommended to return within 30 days of the date you received the product. You can message us with your reason of returning so we can facilitate the request and issue return authorization to you.

3: How to contact you if I have some problems?

Easy! Just message us and provide a detailed description about your problem, we are willing to help you and respond with 24 hours.

Care Instructions

Your furniture, if treated with respect and love, will last you a long time. Each piece requires light maintenance to maximise daily comfort and improve its longevity. Like anything, if you treat it well, that kindness will be repaid back to you. Your furniture is designed to support you and put a smile on your face. It is there to enhance your home, and your life.

1. Position the sofa away from direct sunlight or use curtains or blinds to limit the exposure.
2. Clean the sofa regularly with a dry, soft cloth or a vacuum cleaner with a soft attachment.
3. To remove stubborn stains on fabric, blot affected area immediately with a soft cloth soaked in warm water and mild soap. Then clean off using a dry cloth.
4. Take care not to clean with excessive rubbing. It may damage the weave and discolor the fabric.
5. We recommend fixing felt pads underneath the sofa to prevent scratches on the floor. Placing a rug underneath can also add the right amount of protection and shine to your living space!
6. For optimal care, you should distribute the weight evenly on the cushion regularly.

Follow the care instructions and look after your furniture, in return, your furniture will look after you.

We hope to see you soon!