

TWIN OVER TWIN BUNK BED  
ASSEMBLY INSTRUCTIONS  
SKU : MF291653

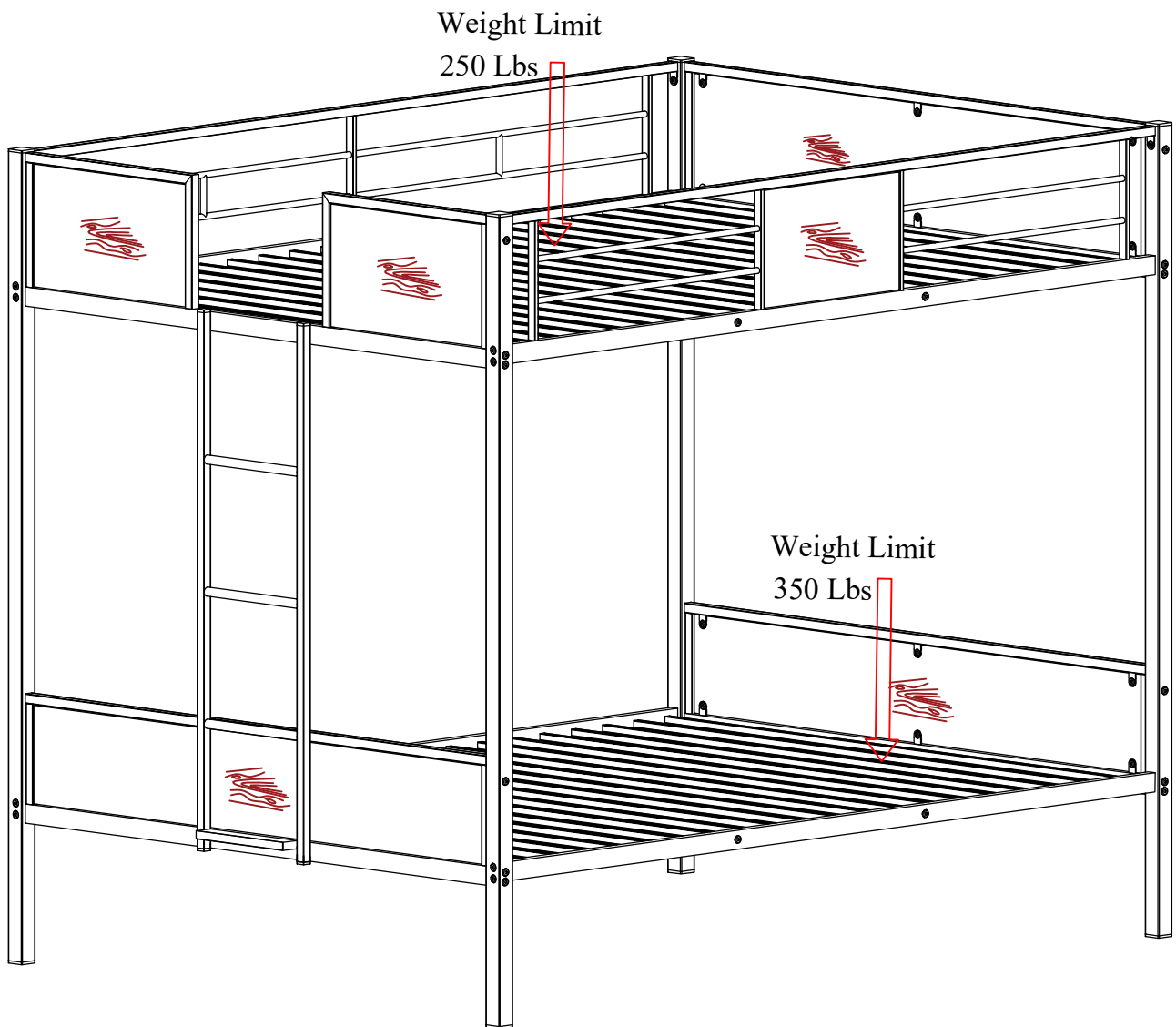



SAFETY WARNING



1.This bed is designed for use only mattress (es) meeting the following specifications on the upper bunk, and lower bunk:

Upper bunk (bunk bed and tribed included)

Bed type	Length	Width	Thickness
Twin	74" – 75"	38½"	6" max

Lower bunk

Bed type	Length	Width	Thickness
Twin	74" – 75"	38½"	8"

2.Replacement parts, including additional guardrails, maybe obtained from any of our (GIGACLOUD TECHNOLOGY(USA) INC. 18961 ARENTH AVENUE, CITY OF INDUSTRY, CA, 91748) dealers.

3.Follow the information on the warnings appearing on the upper bunk bed end structure and on the carton. Do not remove warning label from bed.

4.Always use the recommended size mattresses or mattress supports, or both, to help prevent the likelihood of entrapment or falls.

5.Surface of mattress must be at least 5" (127mm) below the upper edge of guardrails.

6.Do not allow children under 6 years of age to use the upper bunk.

7.Periodically check and ensure that the guardrail, ladder, and other components are in their proper position, free from damage, and that all connectors are tight.

8.Do not allow horseplay on or under the bed and prohibit jumping on the bed.

9.Always use the ladder for entering and leaving the upper bunk.

10.Do not use substitute part. Contact the manufacture or dealer for replacement part.

11.Use of a night light may provide added safety precaution for a child using the upper bunk.

12.Always use guardrails on both long sides of the upper bunk. If the bunk bed will be placed next to the wall, the guardrail that runs the full length of the bed should be placed against the wall to prevent entrapment between the bed and wall.

13.The use of water or sleep flotation mattresses is prohibited.

14.STRANGULATION HAZARD – Never attach or hang items to any part of the bunk bed that are not designed for use with the bed; for example, but not limited to, hook, belts and jump ropes.

15.Keep these instruction for future reference.

16.Prohibit more than one person on upper bunk

17.We recommend assembling your bunk bed on the shipping carton to protect your floor or carpet.

18.Be certain all staples are out of the box before beginning assembly on the shipping carton.

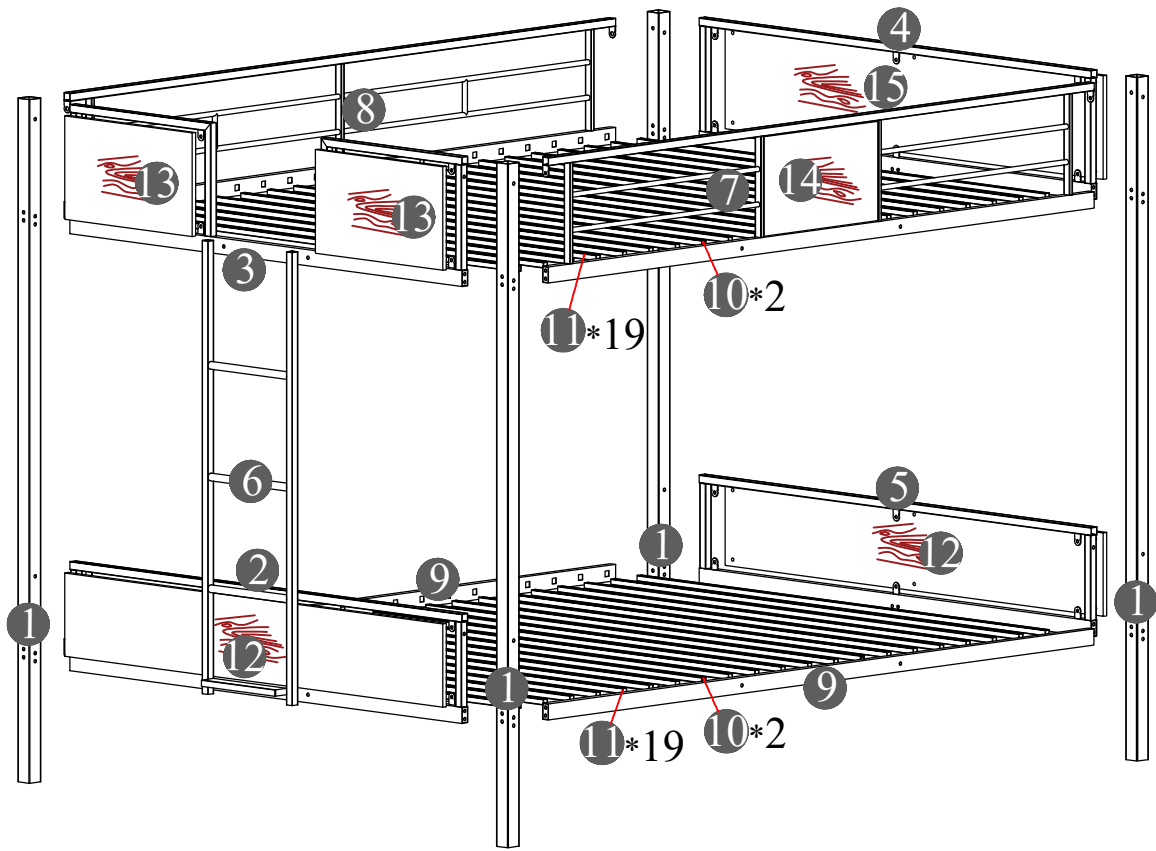

TWIN OVER TWIN BUNK BED  
ASSEMBLY INSTRUCTIONS  
SKU : MF291653

DETAIL VIEW





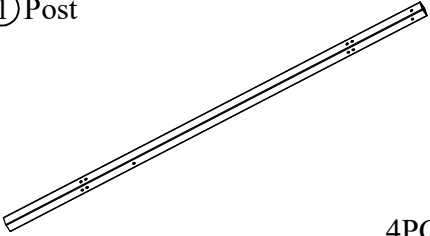
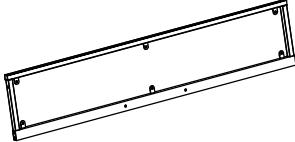
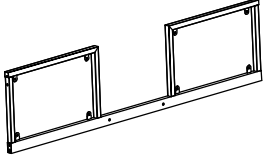
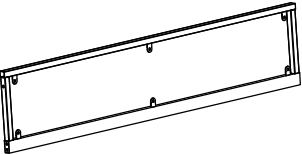
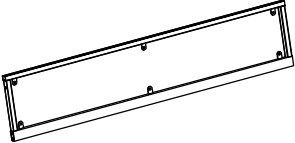
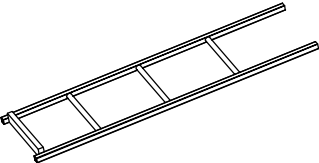
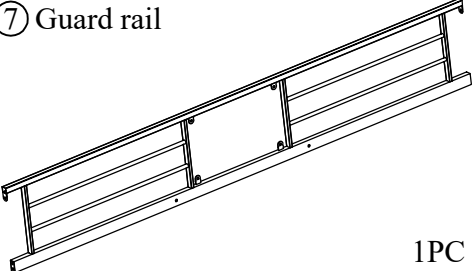
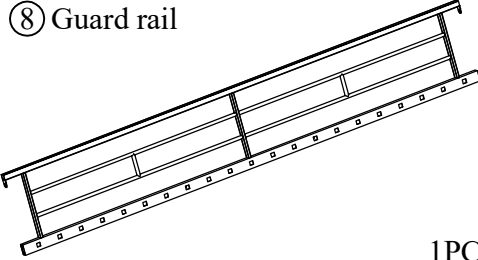
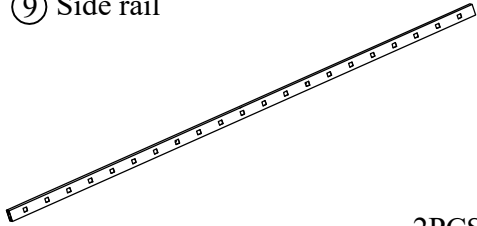
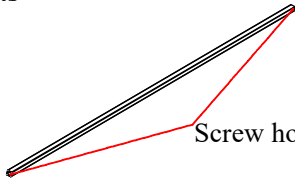
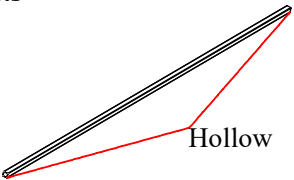
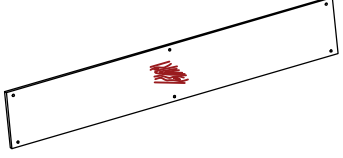
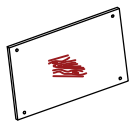

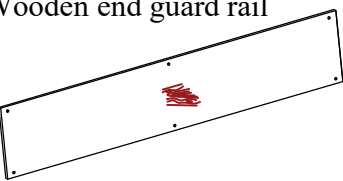

TWIN OVER TWIN BUNK BED  
 ASSEMBLY INSTRUCTIONS  
 SKU : MF291653

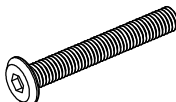
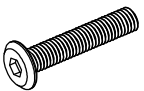
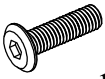
PART LIST

<p>① Post</p>  <p>4PCS</p>	<p>② End guard rail</p>  <p>1PC</p>	<p>③ End guard rail</p>  <p>1PC</p>
<p>④ End guard rail</p>  <p>1PC</p>	<p>⑤ End guard rail</p>  <p>1PC</p>	<p>⑥ Ladder</p>  <p>1PC</p>
<p>⑦ Guard rail</p>  <p>1PC</p>	<p>⑧ Guard rail</p>  <p>1PC</p>	<p>⑨ Side rail</p>  <p>2PCS</p>
<p>⑩ Slats</p>  <p>Screw holes</p> <p>4PCS</p>	<p>⑪ Slats</p>  <p>Hollow</p> <p>38PCS</p>	<p>⑫ Wooden end guard rail</p>  <p>2PCS</p>
<p>⑬ Wooden end guard rail</p>  <p>2PCS</p>	<p>⑭ Wooden guard rail</p>  <p>1PC</p>	<p>⑮ Wooden end guard rail</p>  <p>1PC</p>

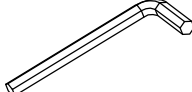



HARDWARE LIST

<p>Ⓐ Bolts</p>  <p>1/4"*55 40PCS</p>	<p>Ⓑ Bolts</p>  <p>1/4"*35 4PCS</p>	<p>Ⓒ Bolts</p>  <p>1/4"*15 12PCS</p>	<p>Ⓓ Bolts</p>  <p>1/4"*10 30PCS</p>
<p>Ⓔ End cap</p>  <p>40*40 8PCS</p>	<p>Ⓕ End cap</p>  <p>20*20 4PCS</p>	<p>Ⓖ Allen key</p>  <p>4*59 1PC</p>	<p>Ⓗ Connect wall</p>  <p>1/4"*40 2Set</p>

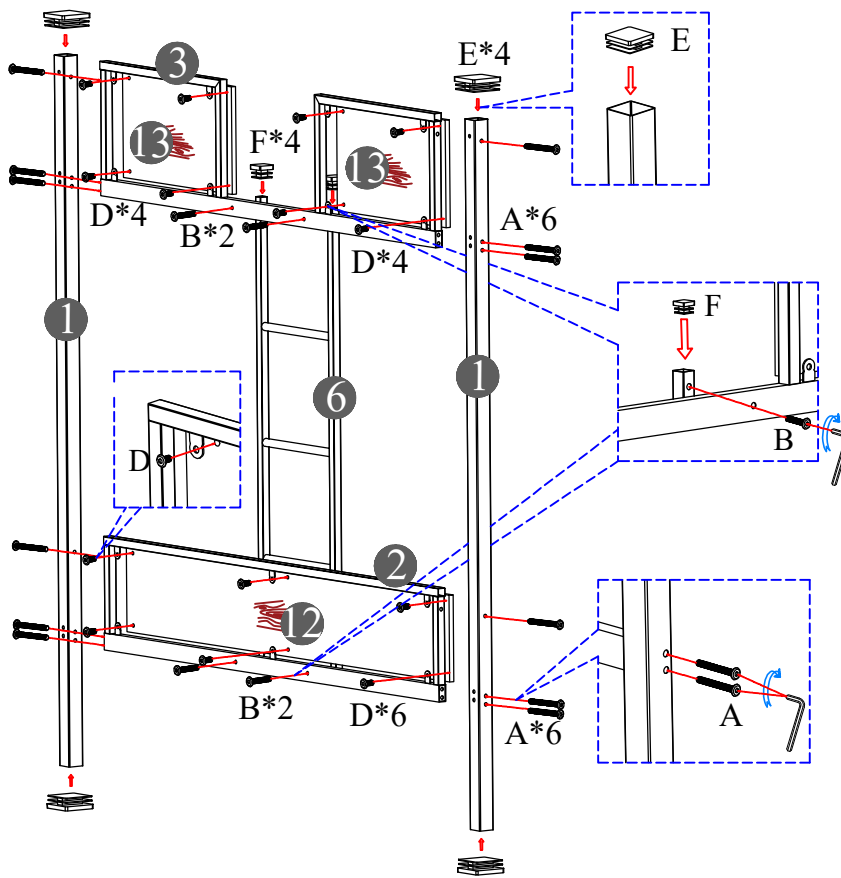
TWIN OVER TWIN BUNK BED  
 ASSEMBLY INSTRUCTIONS  
 SKU : MF291653

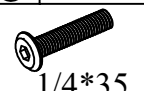
STEP 1 : Following below illustration Assembly Frame #1.  
 Using hardware #A, #B, #D, #E, #F connect #1 with #2, #3, #6, #12, #13 to complete Frame #1.

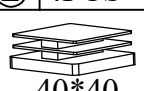

(A)	12PCS
	1/4*55
(B)	4PCS
	1/4*35
(D)	14PCS
	1/4*10
(E)	4PCS
	40*40
(F)	4PCS
	20*20
(G)	1PC
	4*59

NOTE: In this step, DO NOT tighten any bolt until you connect all part together.

TWIN OVER TWIN BUNK BED  
 ASSEMBLY INSTRUCTIONS  
 SKU : MF291653

STEP 2 : Following below illustration Assembly Frame #2.  
 Using hardware #A, #D, #E connect #1 with #4, #5, #12, #15 to complete Frame #2.

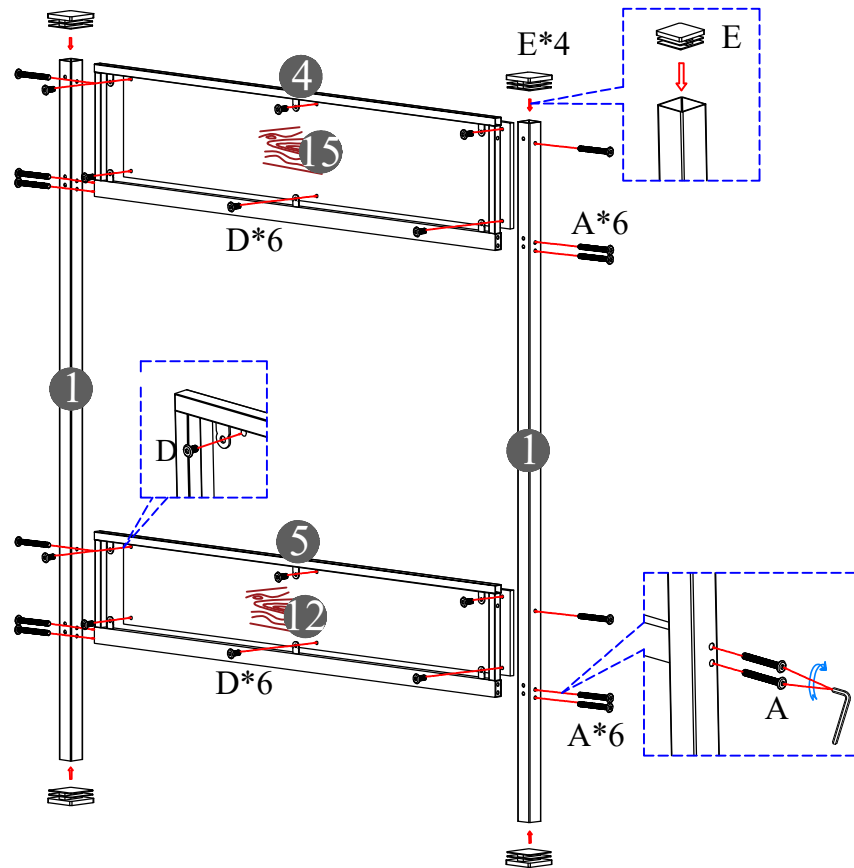

(A)	12PCS
(D)	12PCS
(E)	4PCS
(G)	1PC

NOTE: In this step, DO NOT tighten any bolt until you connect all part together.

STEP 3 : Following below illustration Assembly Frame #3.  
 Using hardware #C connect #9 with #10, #11 to complete Frame #3.

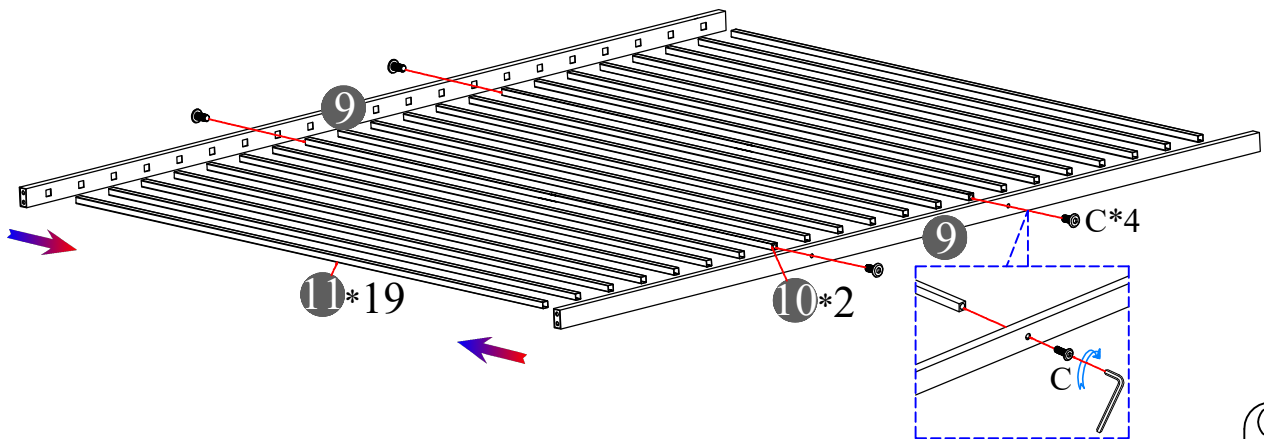

(C)	4PCS
(G)	1PC

NOTE: In this step, DO NOT tighten any bolt until you connect all part together.

TWIN OVER TWIN BUNK BED  
 ASSEMBLY INSTRUCTIONS  
 SKU : MF291653

STEP 4 : Following below illustration Assembly Frame #4.  
 Using hardware #C, #D connect #7, #8 with #10, #11, #14 to complete Frame #4.

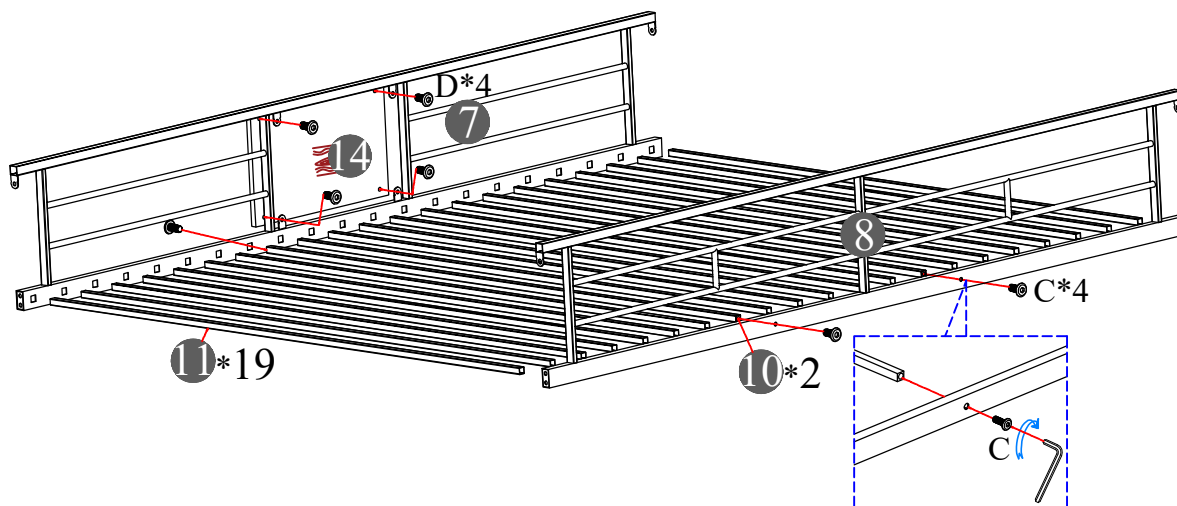

Ⓒ	4PCS
	1/4*15
Ⓓ	4PCS
	1/4*10
Ⓖ	1PC
	4*59

NOTE: In this step, DO NOT tighten any bolt until you connect all part together.

STEP 5 : Following below illustration Assembly Frame #5.  
 Using hardware #A, #C connect Frame #1, #2 with Frame #3, #4 to complete Frame #5.

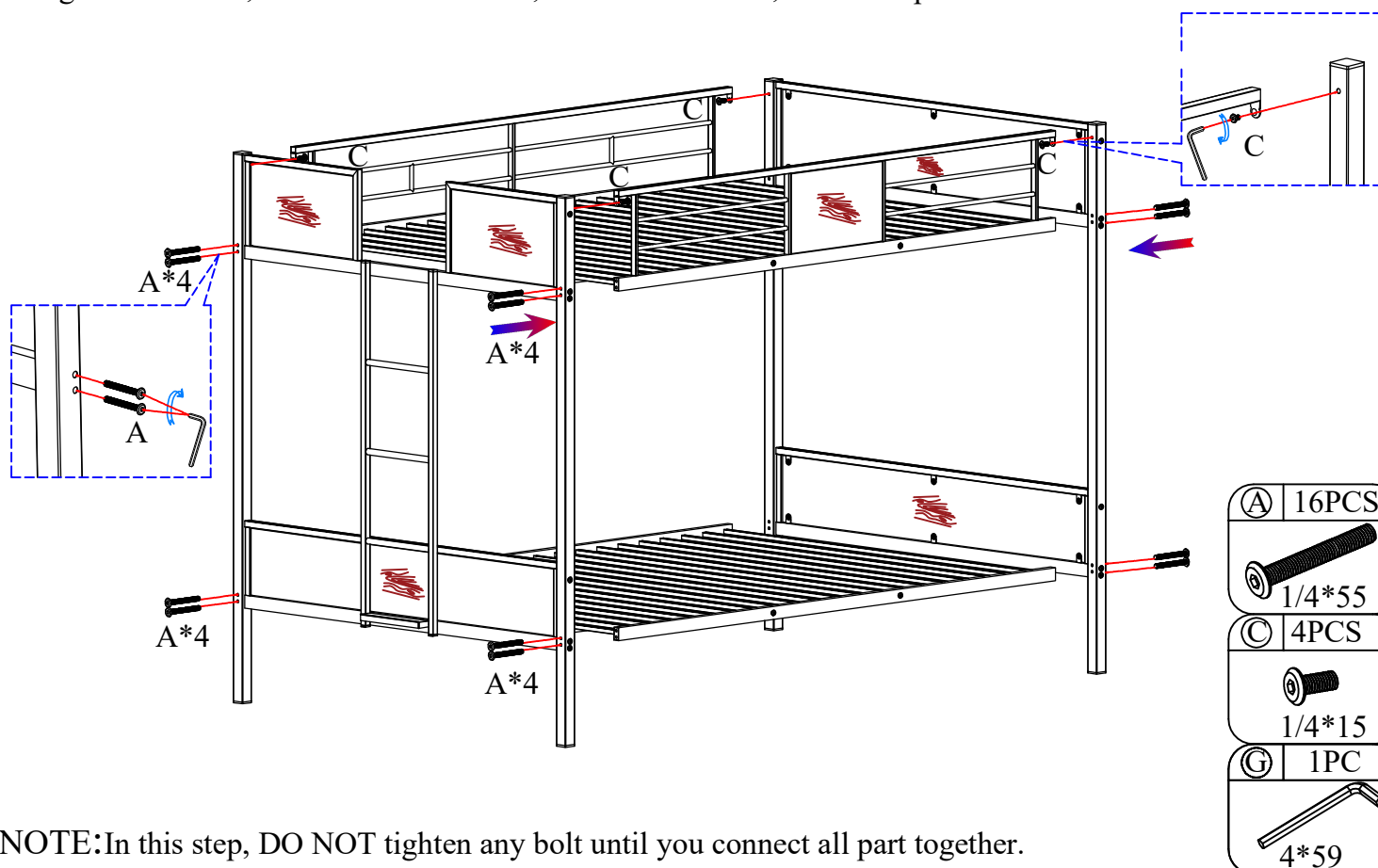

Ⓐ	16PCS
	1/4*55
Ⓒ	4PCS
	1/4*15
Ⓖ	1PC
	4*59

NOTE: In this step, DO NOT tighten any bolt until you connect all part together.

TWIN OVER TWIN BUNK BED  
ASSEMBLY INSTRUCTIONS  
SKU : MF291653

STEP 6 : Following below illustration Assembly Frame # 6.  
Using hardware #H connect Frame #5 with Wall to complete .

COMPLETED BUNK BED

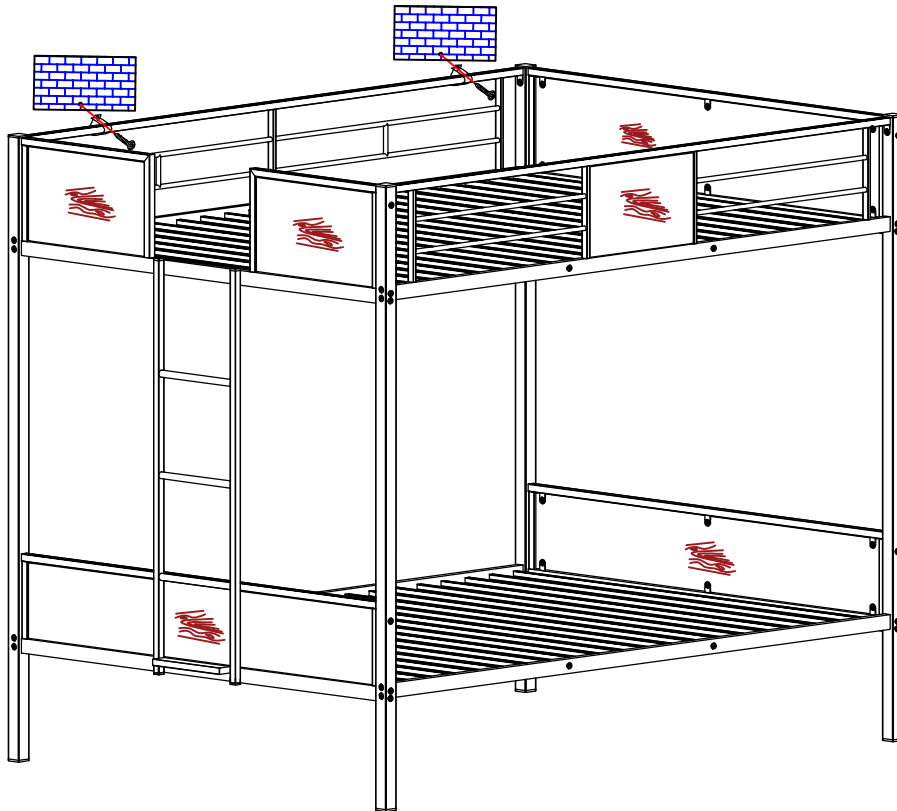

NOTE: Tighten all step before using. Thank you.

H	2 SET
G	1PC
4*59	

