

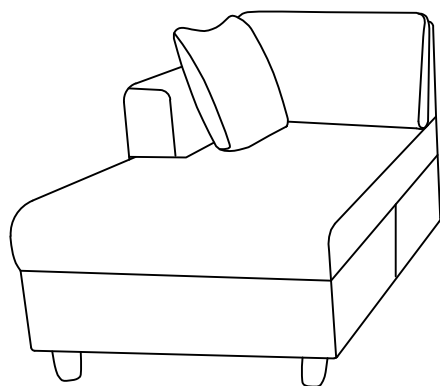

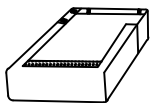



# ASSEMBLY INSTRUCTION

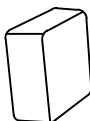
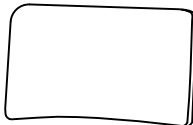

## PARTS LIST

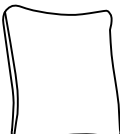
Seat frame  A x1	Back Cushion  D x1	Armrest-L  E x1	Backrest  G x1	Seat cushion  H x1	Pillows  K x1
--	--	---	--	--	---

## SIDE ACCESSORY KIT

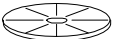
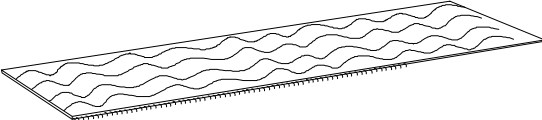
L  x4	 x4	M Velcro connection  x2
--	---	---

## ASSEMBLY INSTRUCTION

Step1:Screw the wooden legs clockwise.

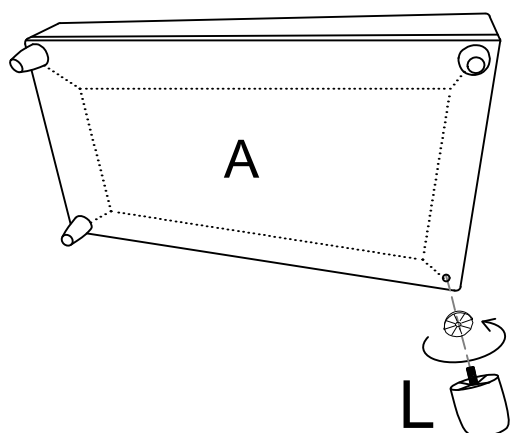

Step2: Seat cushion assembly

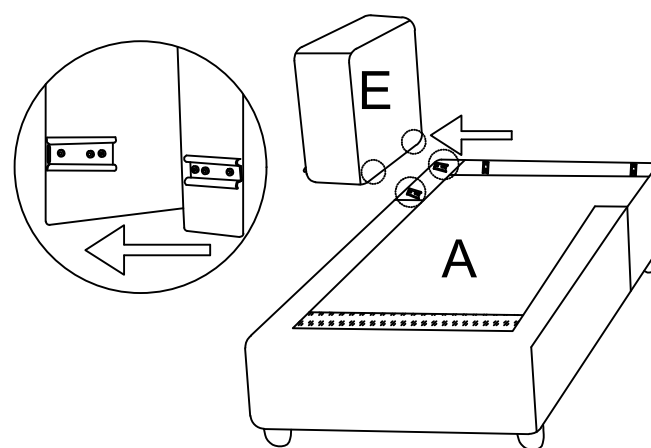

Step3:Backrest assembly

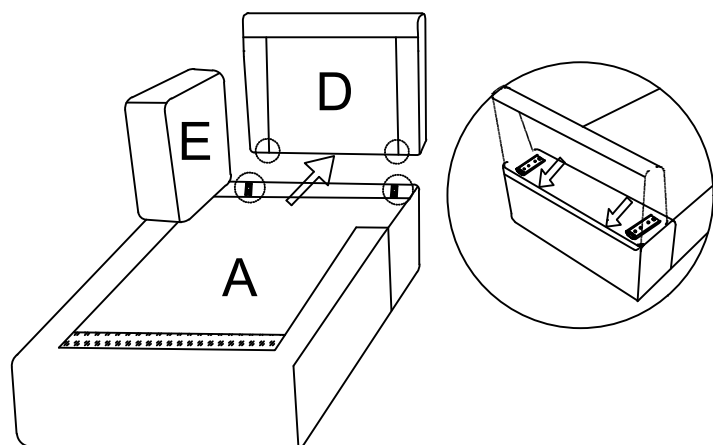

Step4

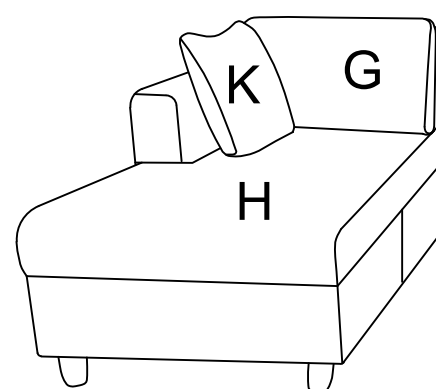

# ASSEMBLY INSTRUCTION

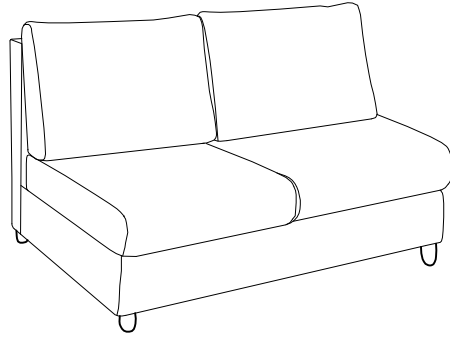

## PARTS LIST

Seat frame

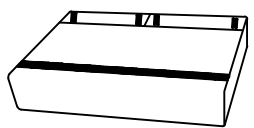

B x1

Back Cushion

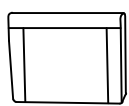

D x2

Backrest

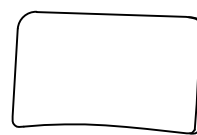

G x2

Armrest

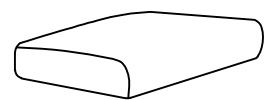

I x2

## CENTRE POSITION FITTING KIT

L



x4

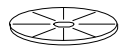

x4

M

Velcro connection

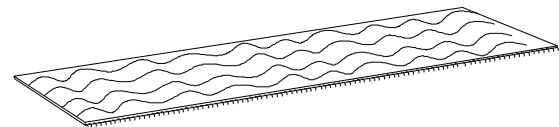

x2

## ASSEMBLY INSTRUCTION

Step1

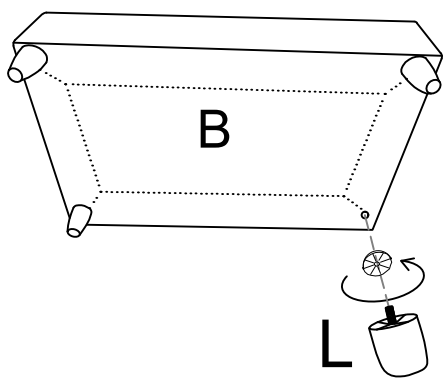

Step2: Backrest assembly

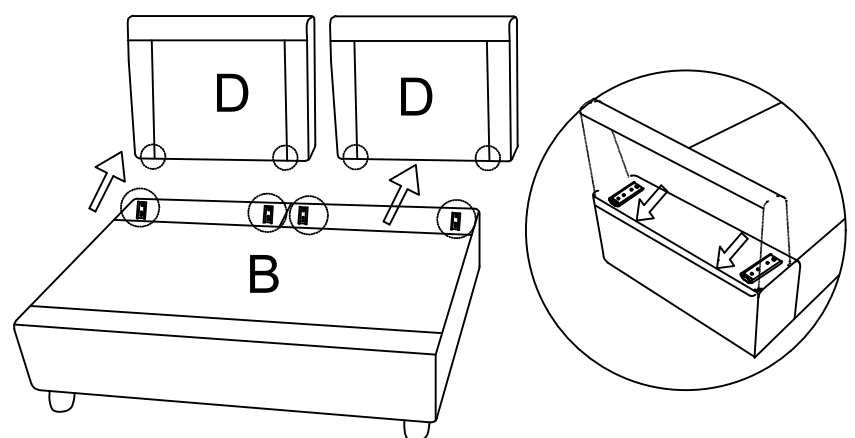

Step3

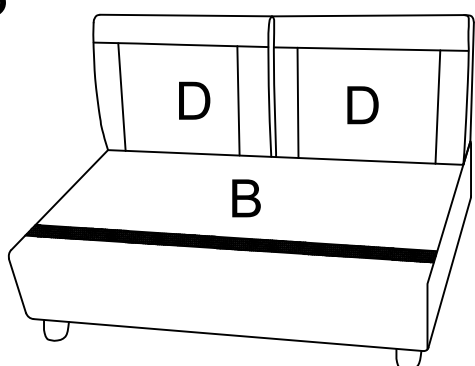



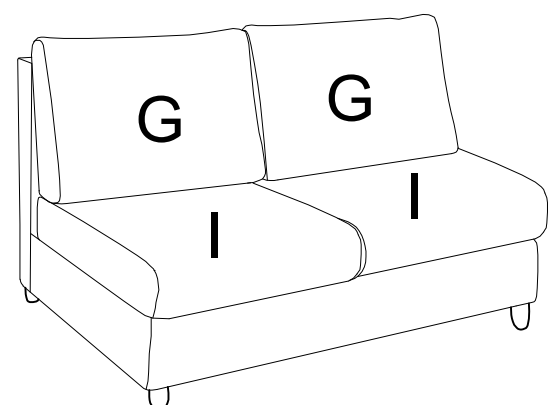

Step4

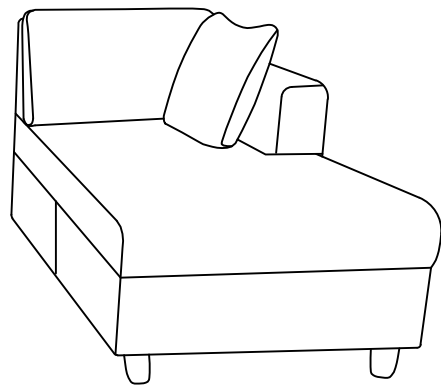

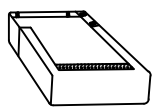
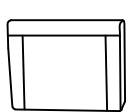

# ASSEMBLY INSTRUCTION

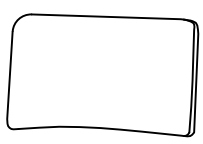

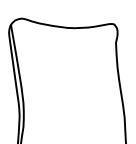
## PARTS LIST

Seat frame  C x1	Back Cushion  D x1	Armrest-R  F x1	Backrest  G x1	Seat cushion  J x1	Pillows  K x1
--	--	---	--	--	---

## SIDE ACCESSORY KIT

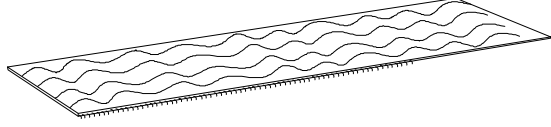
L  x4	 x4	M Velcro connection  x2
--	---	---

## ASSEMBLY INSTRUCTION

Step1: Screw the wooden legs clockwise.

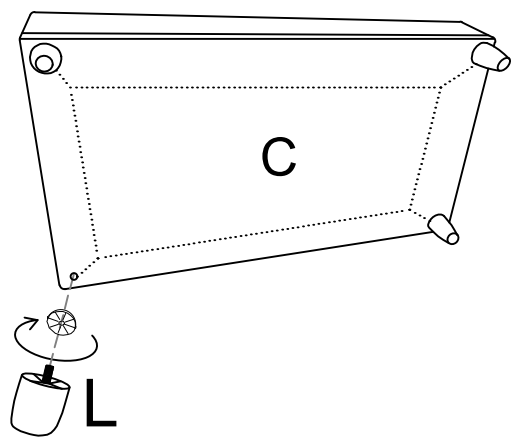

Step2: Seat cushion assembly

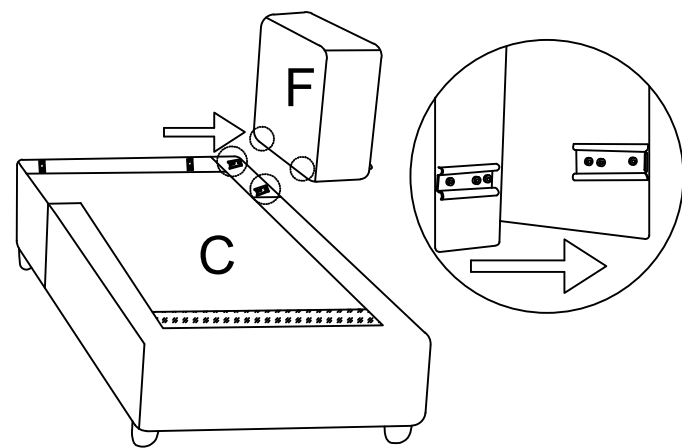

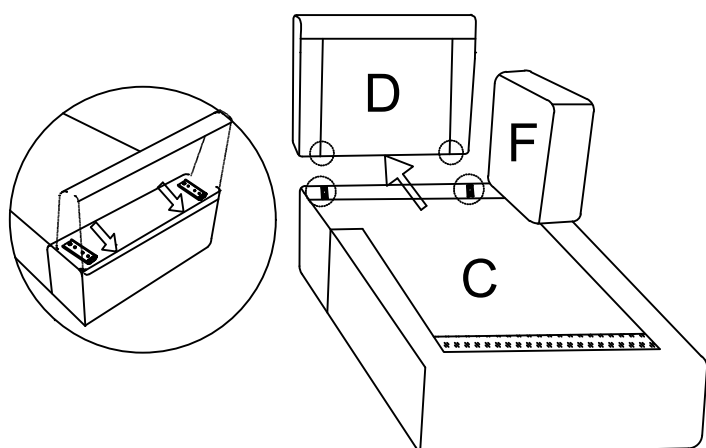

Step3: Backrest assembly

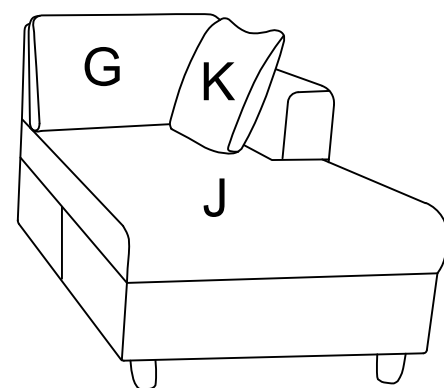

Step4

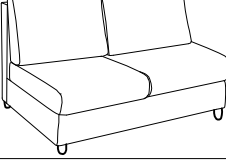
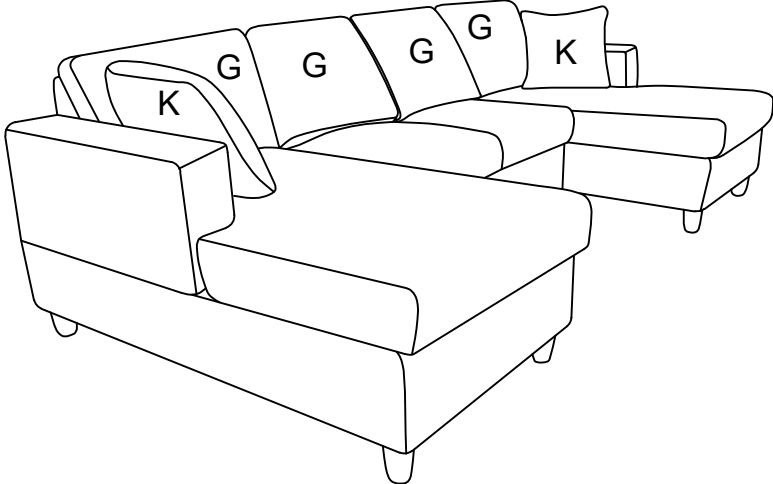

2219 PARTS		Quantity	2219 SECTIONALSOFA
	2219-L	X1	
	2219-R	X1	
	2219-middle part	X1	
M	Velcro connection	X6	

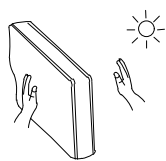
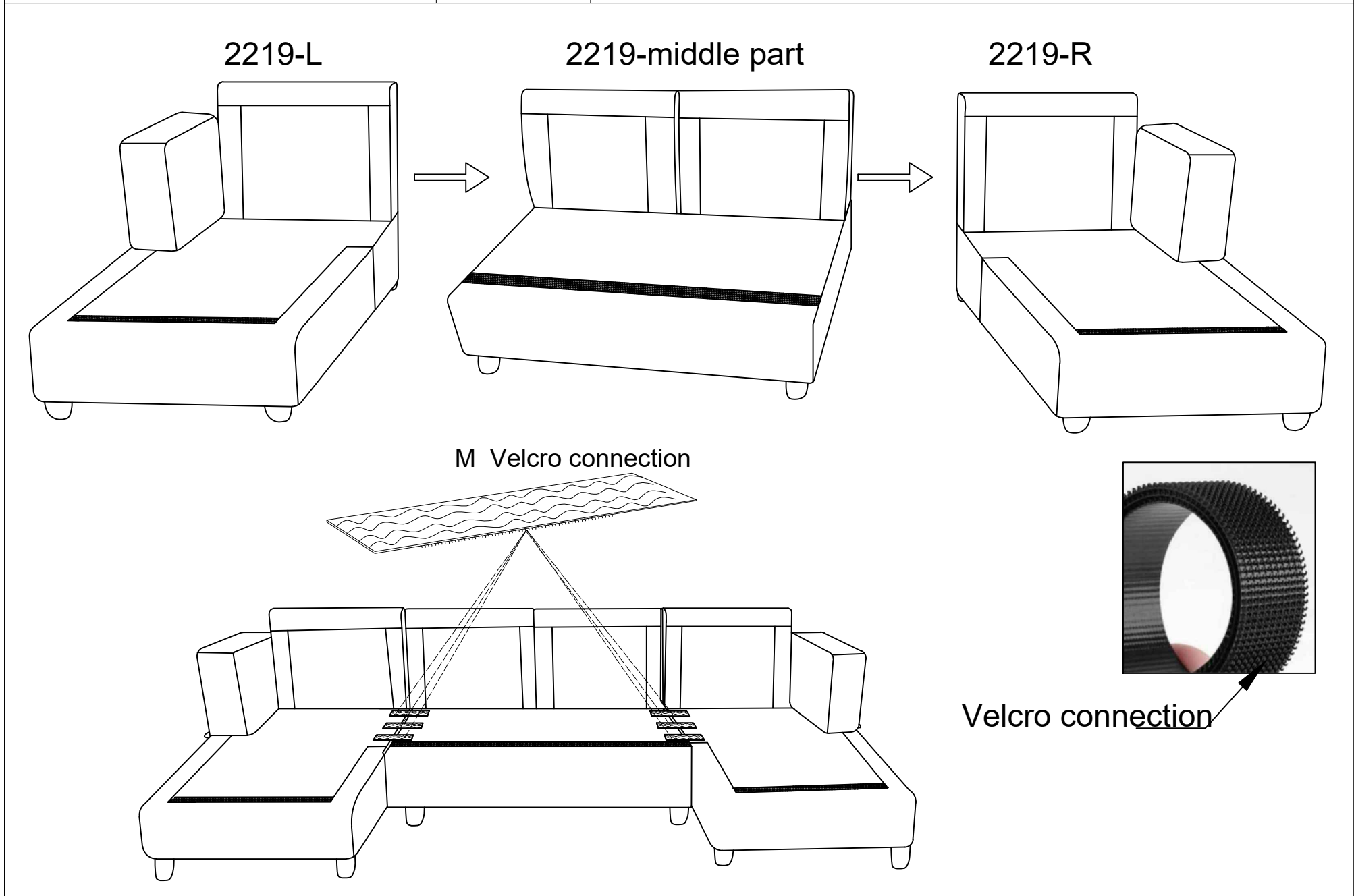

Tap the backrest and place it in the sunlight to fluff it up quickly, it takes about 10 minutes for the backrest to fluff up.  
 Pay attention: Because of the compressed packaging, there may be some creases on the cover. Please do not worry, pat it several times and wait for moments, the crease will be more natural and will not affect the use.

