





CARE AND MAINTENANCE

Spot clean using a mild water-free solvent. Only a professional cleaner should undertake a complete overall cleaning.
The use of steam or water-based cleaners may cause excessive shrinking or staining.

NOTICE

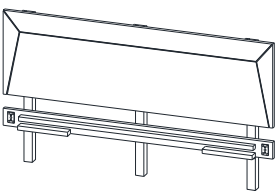
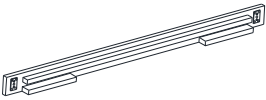
- * Please make sure that you have all parts indicated before you begin assembly of this item
- * This item should be assembled on a soft surface to prevent scratching the finish during assembly
- * This item may require periodic tightening

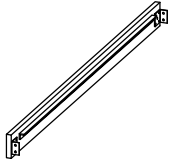
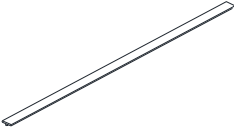
Part List and Hardware List

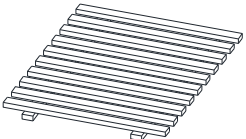

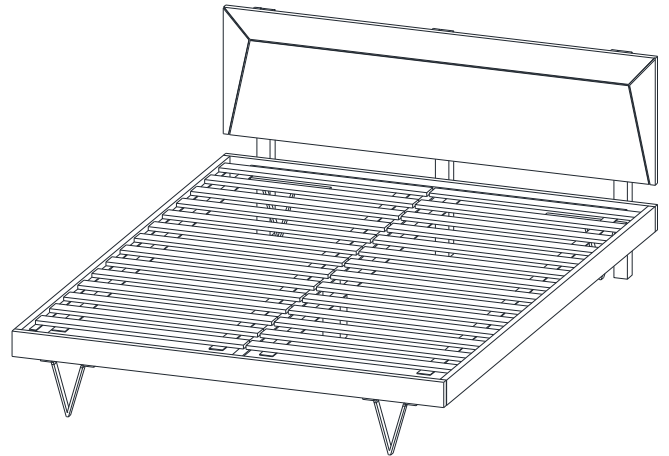

PIECE	DESCRIPTION	PICTURE	QUANTITY
A	HEADBOARD		1X
B	FOOTBOARD		1X
C	LEG		4X
D	SIDE RAIL		2X
E	MID RAIL		1X
F	CENTER LEG		2X
G	SLAT		4X

Product dimensions: 79.9"W X 83.8"D X 44"H

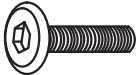

⚠ WARNING ⚠

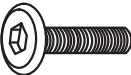
Weight Capacity - 450 LBS
Warning : Do not over torque bolts.

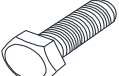
PIECE	DESCRIPTION	PICTURE	QUANTITY	PIECE	DESCRIPTION	PICTURE	QUANTITY
HW1	ALLEN BOLT M6 x 25 MM		20X	HW5	SPANNER 16-17 MM		1X
HW2	WASHER M8 x 16 MM		20X	HW6	ALLEN BOLT M6 x 50 MM		2X
HW3	ALLEN KEY 4 MM		1X	HW7	WASHER M8 x 25 MM		2X
HW4	HEX BOLT M8 x 20 MM		8X				

PREPARATION

Before beginning assembly of product, make sure all parts are present. Compare parts with package contents list and hardware contents list.

If any part is missing or damaged, do not attempt to assemble the product.

Estimated Assembly Time: 20 minutes.

Tools Required for Assembly (included): Spanner

STEP :- 1

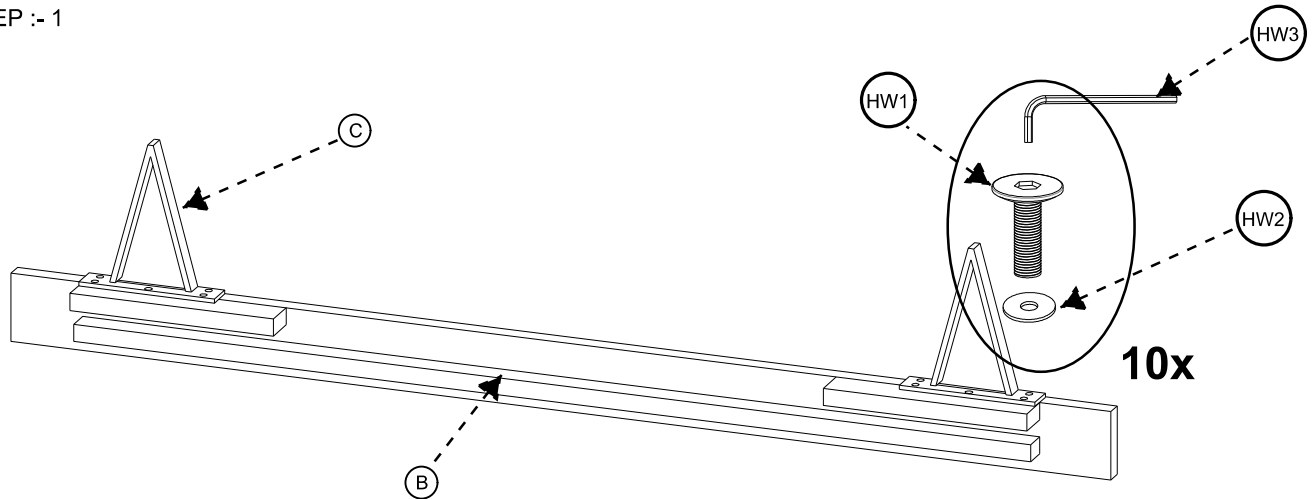

STEP :- 2

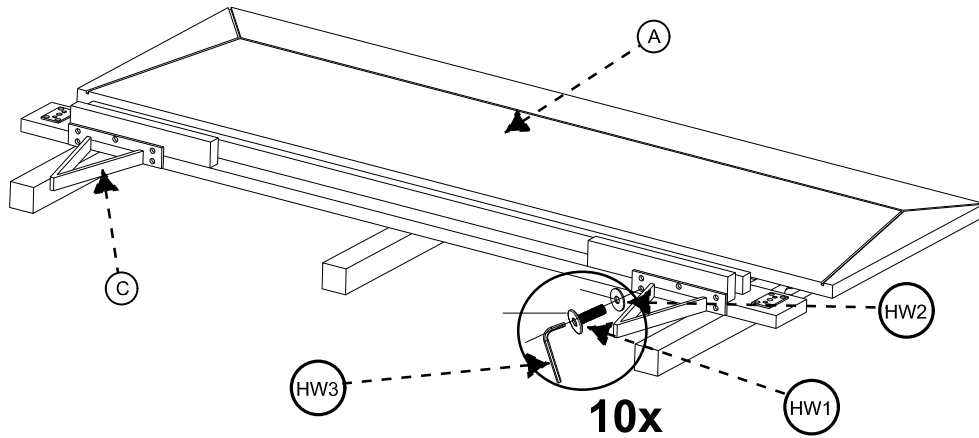

STEP :- 3

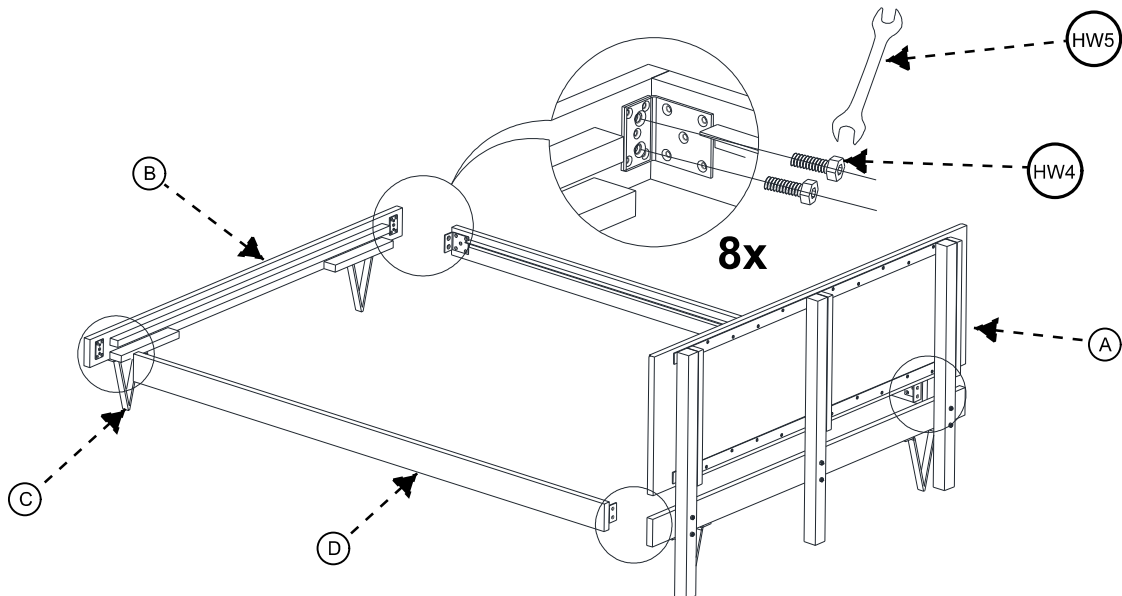

STEP 1 :- Place leg (C) on to the footboard (B) as shown. Insert allen bolt (HW1) with washer (HW2) and tighten with allen key (HW3).

STEP 2 :- Place leg (C) on to the headboard (A) as shown. Insert allen bolt (HW1) with washer (HW2) and tighten with allen key (HW3).

STEP 3 :- Align side rail (D) with headboard (A) and footboard (B) then insert hex bolt (HW4) and tighten with spanner (HW5).

PREPARATION

Before beginning assembly of product, make sure all parts are present. Compare parts with package contents list and hardware contents list.

If any part is missing or damaged, do not attempt to assemble the product.

Estimated Assembly Time: 20 minutes.

Tools Required for Assembly (included): Spanner

STEP :- 4

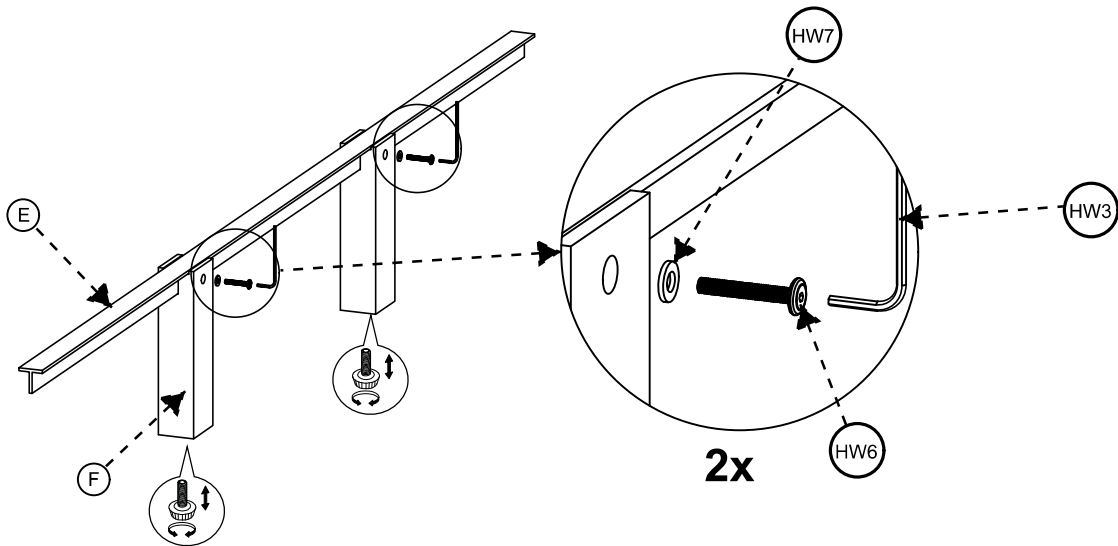

STEP :- 5

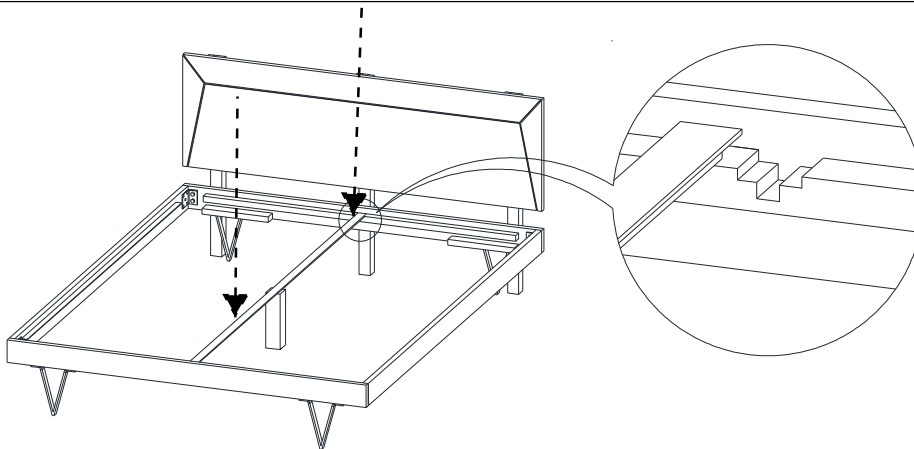

STEP :- 6

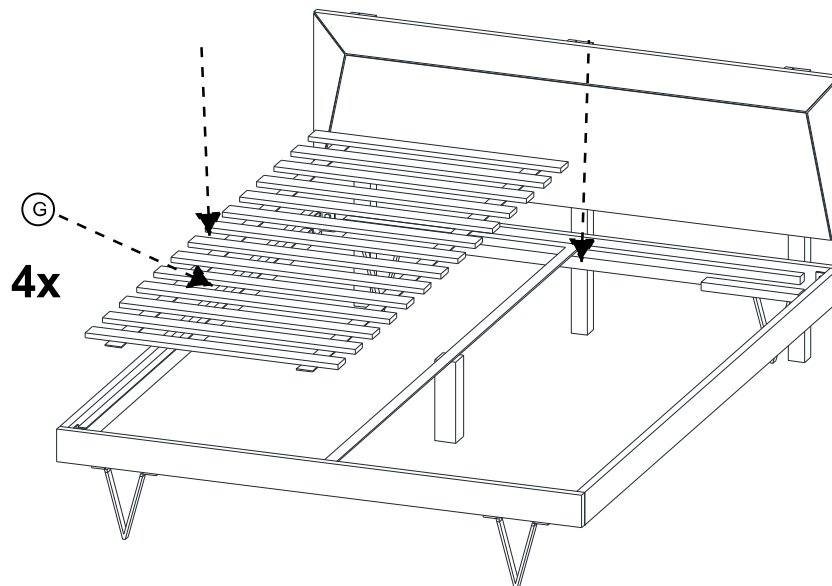

STEP 4 :- Fix the center leg (F) into the mid rail (E) as shown. Insert allen bolt (HW6) with washer (HW7) and tighten with allen key (HW3).

STEP 5 :- Place mid rail (E) onto the slots of headboard and footboard.

STEP 6 :- Place slats (G) gently.