

ASSEMBLY INSTRUCTIONS

TRIPLE BUNK BED

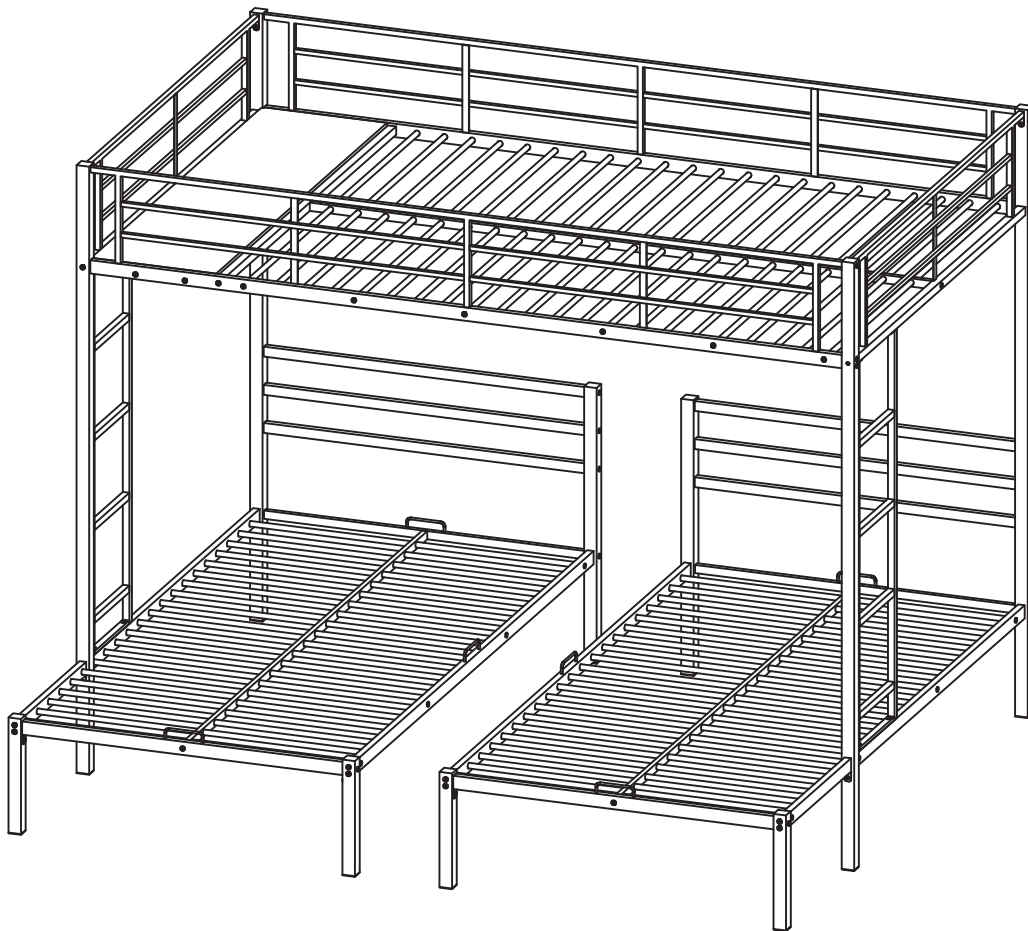

SAFETY WARNINGS AND GENERAL NOTES

1. Follow the information on the warnings on the upper bunk bed end structure and on the carton. Do not remove the warning label from the bed.
2. Always use the recommended size mattress or mattress support, or both, to help prevent the likelihood of entrapment or falls.
3. Do not allow children under 6 years of age to use the upper bunk.
4. Periodically check and ensure the guardrail, ladder and other components are in their proper position, free from damage, and all connectors are tight.
5. Do not allow horseplay on or under beds.
6. Always prohibit jumping on the bed.
7. Prohibit more than one person on upper bunk.
8. Always use the ladder for entering and leaving the upper bunk.
9. Do not use substitute parts. Contact the manufacturer or dealer for replacement parts.
10. Use of a night light may provide added safety precaution for a child using the upper bunk.
11. Always use guardrails on both long sides of the upper bunk.
12. If the bunk bed will be placed next to a wall, the guardrail that runs the full length of the bed should be placed against the wall to prevent entrapment between the bed and the wall. The use of water or sleep flotation mattresses is prohibited.
13. STRANGULATION HAZARD- Never attach or hang items to any part of the bunk bed that are not designed for use with the bed; for example, but not limited to, hooks, belts and jump ropes.
14. Keep these instructions for future reference.
15. We recommend assembling your bunk bed on the shipping carton to protect your floor or carpet.
16. Be certain all staples are out of the box before beginning assembly on the shipping carton.
17. USE ONLY MATTRESSES WHICH ARE AS THE TABLE BELOW ON UPPER AND ON LOWER BUNKS.

Lower bed

Bed type	Length	Width	Thickness
Twin Standard	74" – 75"	38-1/2"	6"

Upper bed (bunk bed and tribed included)

Bed type	Length	Width	Thickness
Full Standard	74" – 75"	53-1/2"	6" max

18. SURFACE OF MATTRESS MUST BE AT LEAST 5" (127MM) BELOW THE UPPER EDGE OF GUARDRAILS.

19. Replacement Parts:





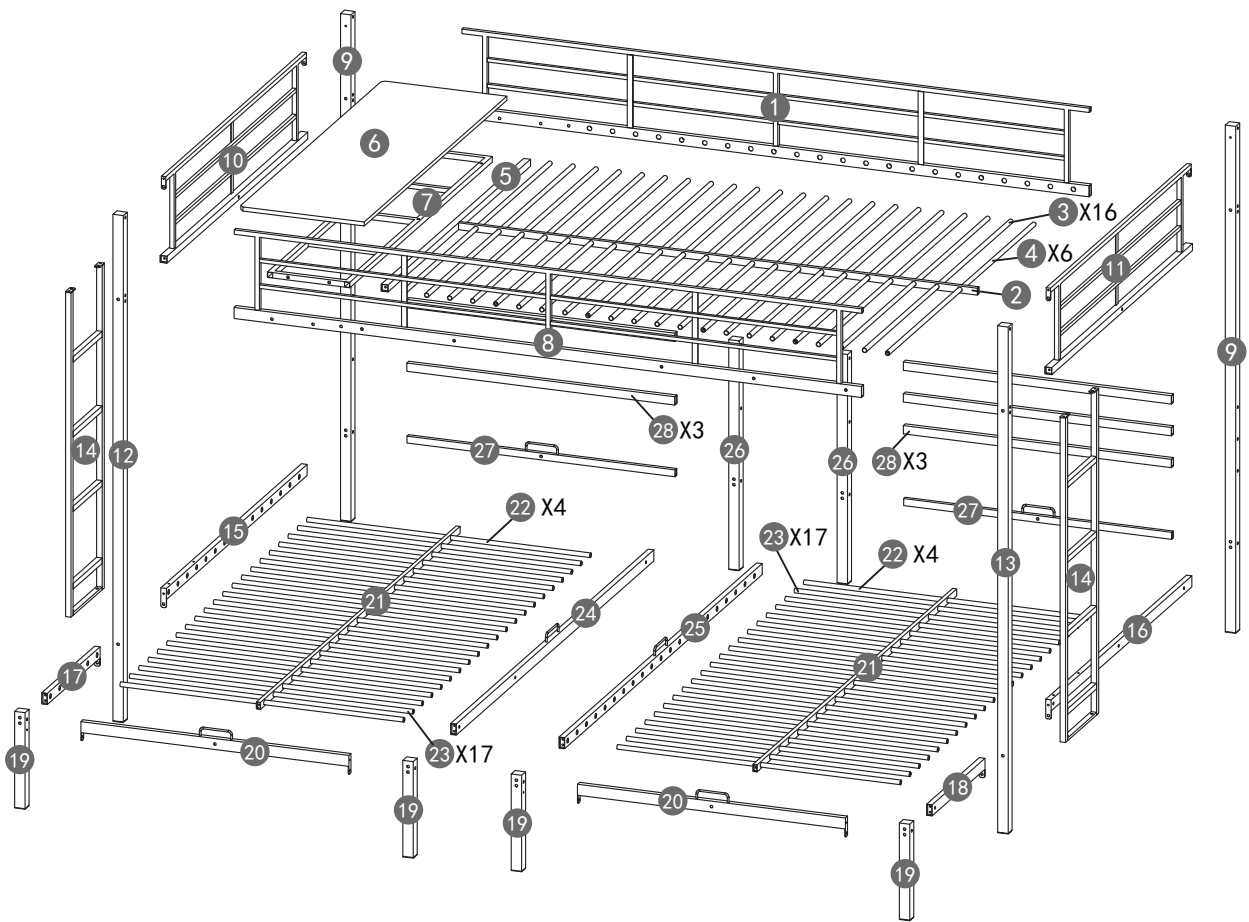







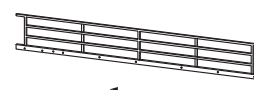

Replacement Parts, including additional guardrails, may be obtained from any of our dealers

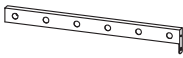
Detail View













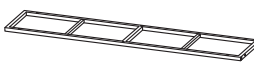

Part List

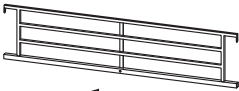
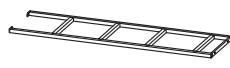

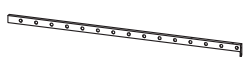



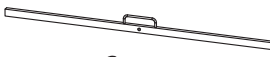



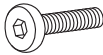

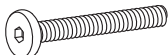
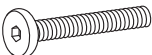
Part List

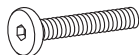
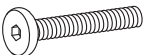
1  1pc	2  1pc	8  1pc
9  2pcs	12  1pc	13  1pc
17  1pc	18  1pc	19  4pcs
21  2pcs	24  1pc	25  1pc
26  2pcs	28  6pcs	

Part List

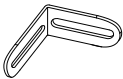
3  16pcs	4  6pcs	5  1pc
6  1pc	7  1pc	10  1pc
11  1pc	14  2pcs	15  1pc
16  1pc	20  2pcs	22  8pcs
23  34pcs	27  2pcs	

Hardware List

<p>a</p>  <p>M6*30mm</p>	<p>b</p>  <p>M6*15mm</p>	<p>c</p>  <p>M6*60mm</p>
<p>10pcs</p>	<p>12pcs</p>	<p>52pcs</p>
<p>d</p>  <p>M6*50mm</p>	<p>e</p>  <p>M6*20mm</p>	<p>f</p>  <p>M6*40mm</p>
<p>2pcs</p>	<p>32pcs</p>	<p>6pcs</p>
<p>g</p>  <p>M6*45mm</p>	<p>h</p>  <p>M6mm</p>	<p>i</p>  <p>M4</p>
<p>2pcs</p>	<p>2pcs</p>	<p>1pc</p>
<p>j</p>  <p>10mm</p>	<p>k</p> 	<p>l</p>  <p>ø6</p>
<p>1pc</p>	<p>2pcs</p>	<p>2pcs</p>
<p>m</p>  <p>M4*30mm</p>	<p>n</p>  <p>ø13*1</p>	
<p>4pcs</p>	<p>4pcs</p>	

STEP 1:

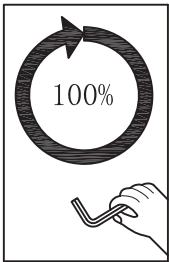
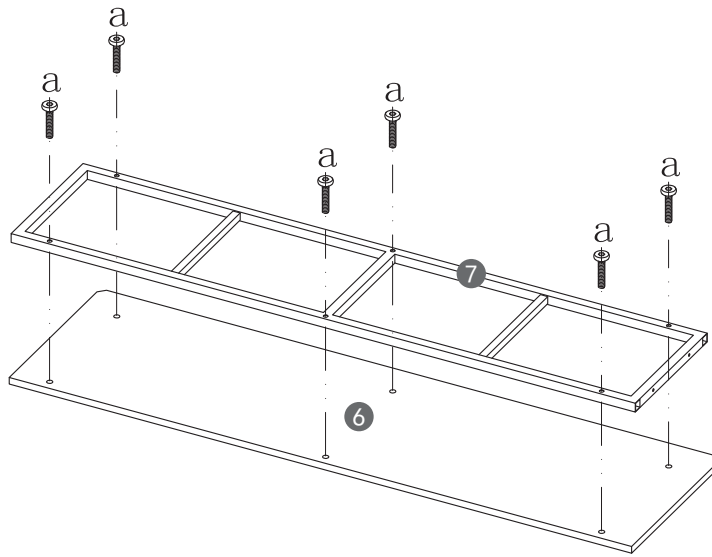

a	x6
M6*30mm	

STEP 2:

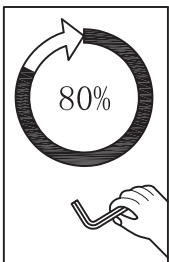
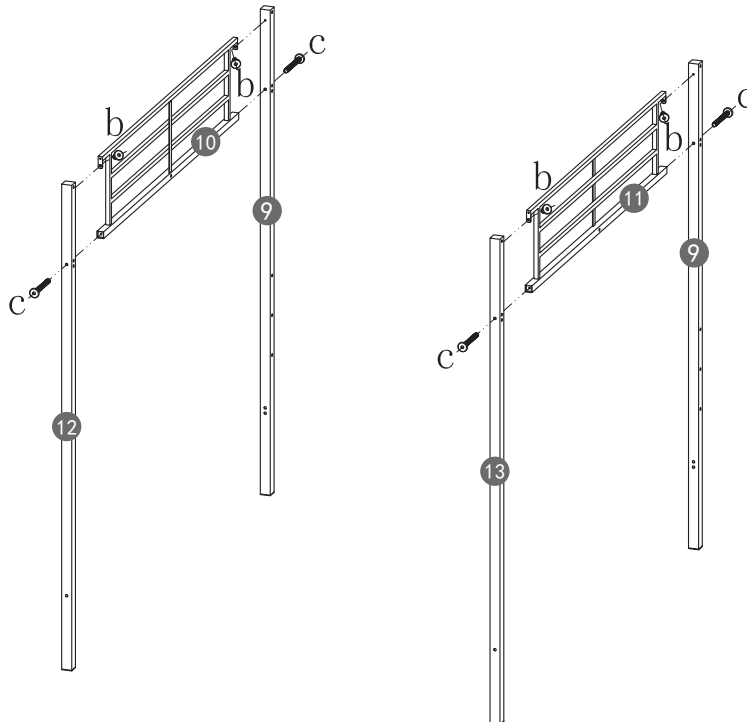

b	x4
M6*15mm	
c	x4
M6*60mm	

STEP 3:

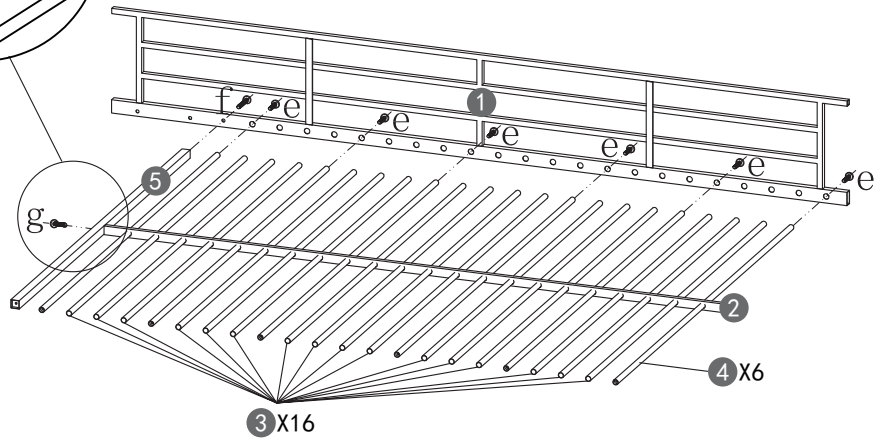
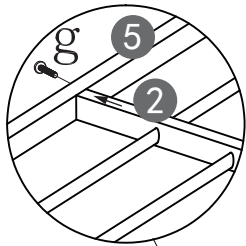
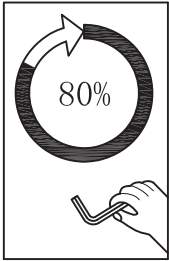

e x6



M6*20mm

f x1

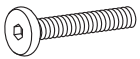

M6*40mm

g x1

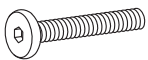

M6*45mm

STEP 4:

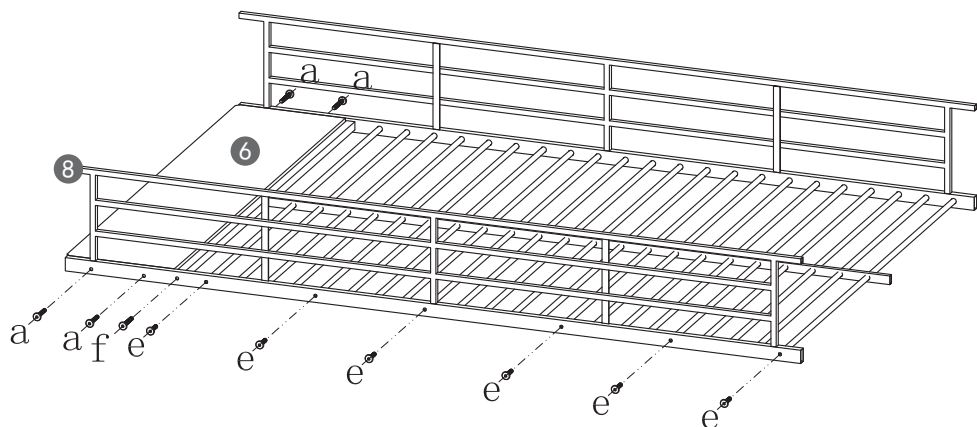
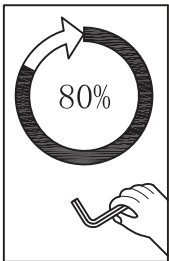

a x4

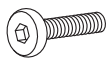

M6*30mm

e x6



M6*20mm

f x1



M6*40mm

STEP 5:

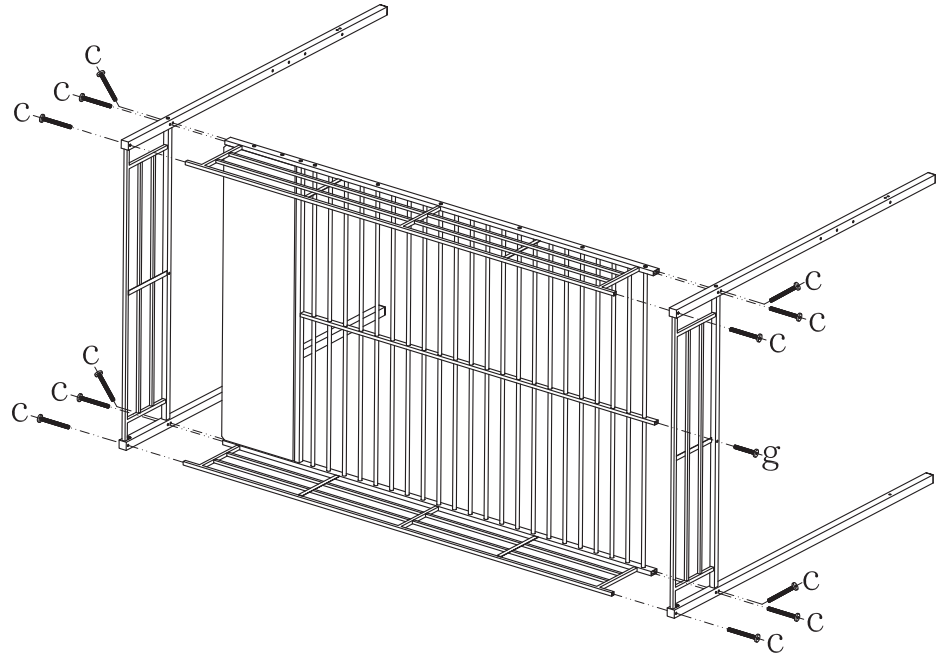
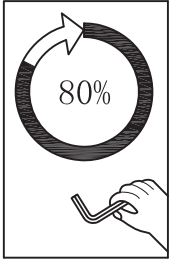

c x12

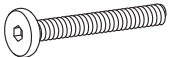

M6*60mm

g x1

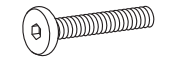

M6*45mm

STEP 6:

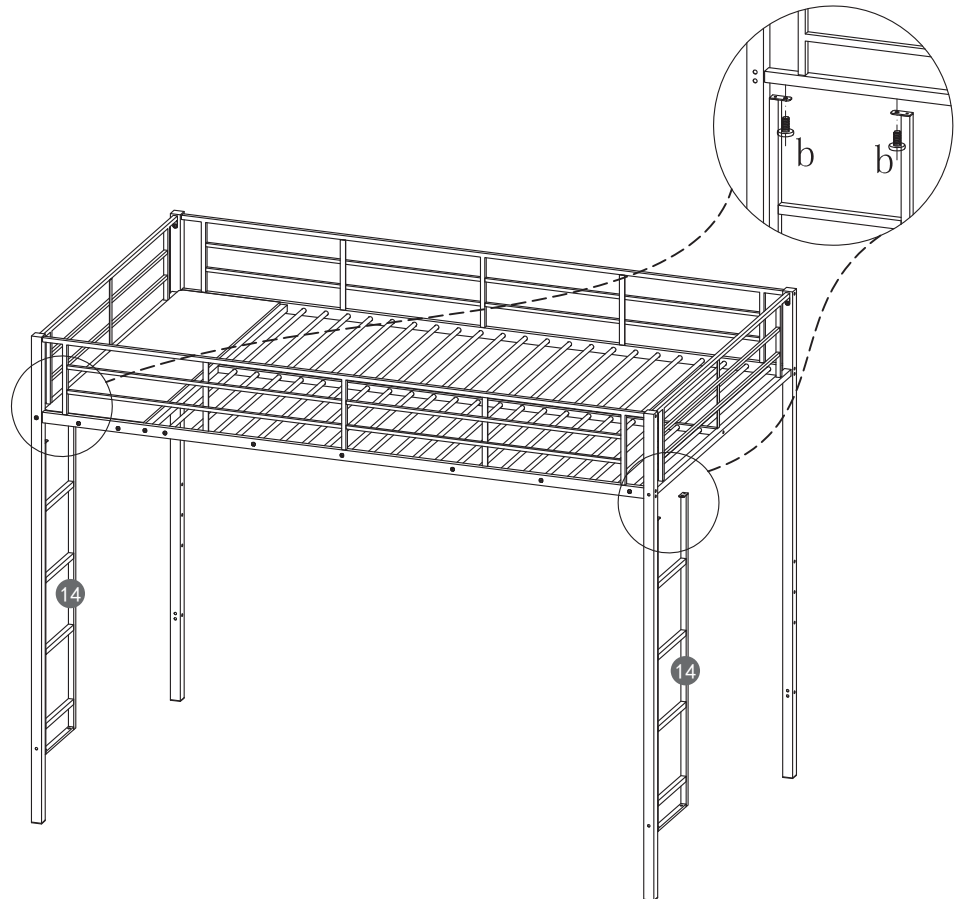
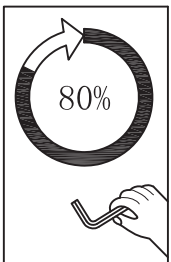

b x4

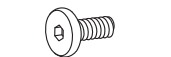

M6*15mm

STEP 7:

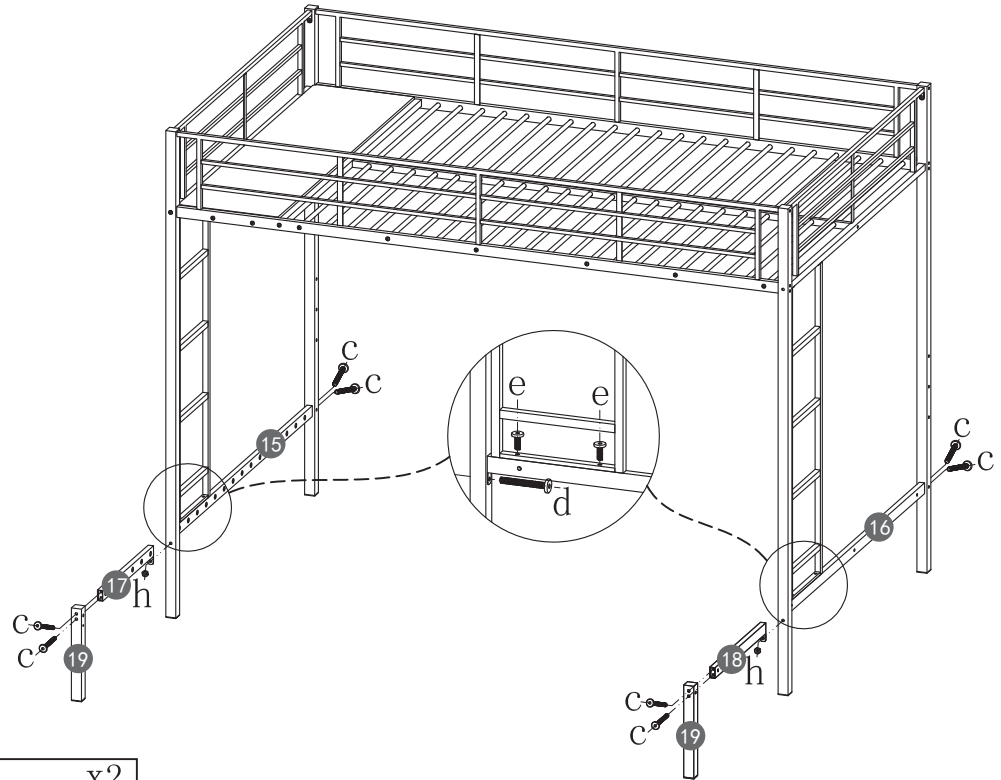
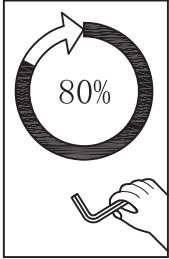

c x8

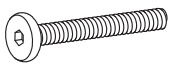

M6*60mm

d x2

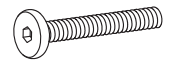

M6*50mm

e x4

h x2



M6*20mm



M6

STEP 8:

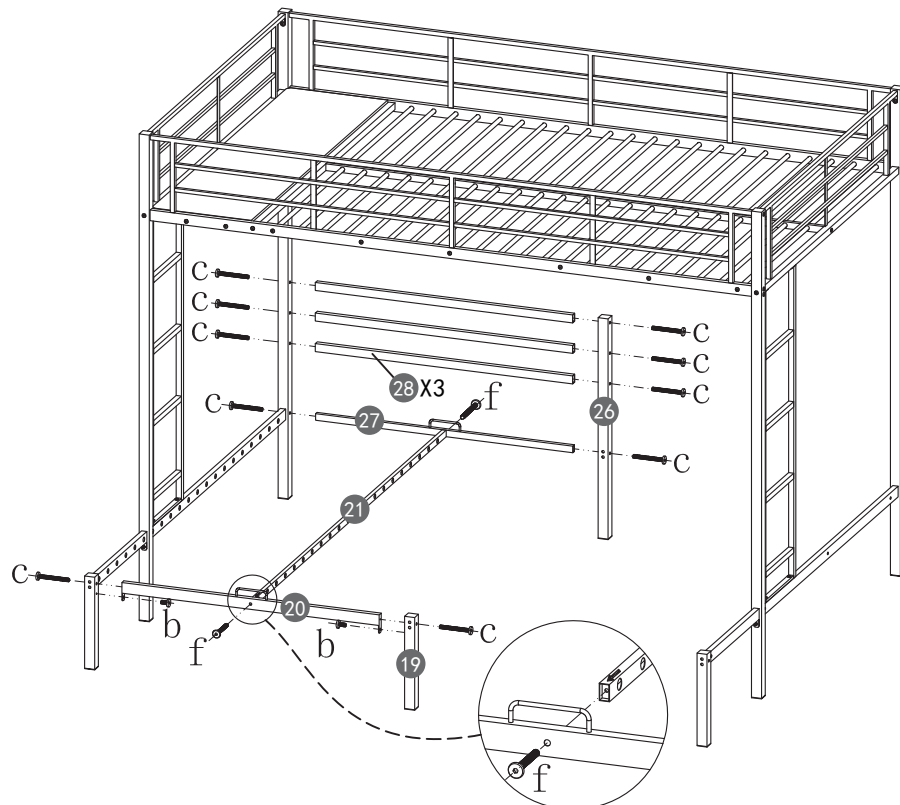
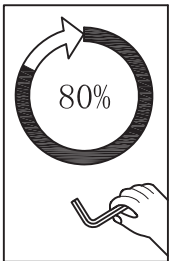

b x2



M6*15mm

c x10

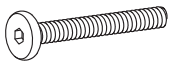

M6*60mm

f x2

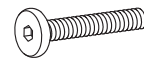

M6*40mm

STEP 9:

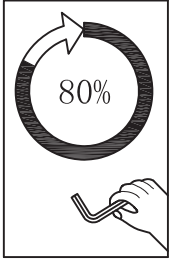

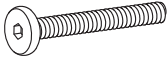
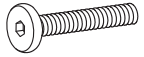
b	x2
	
M6*15mm	
c	x10
	
M6*60mm	
f	x2
	
M6*40mm	

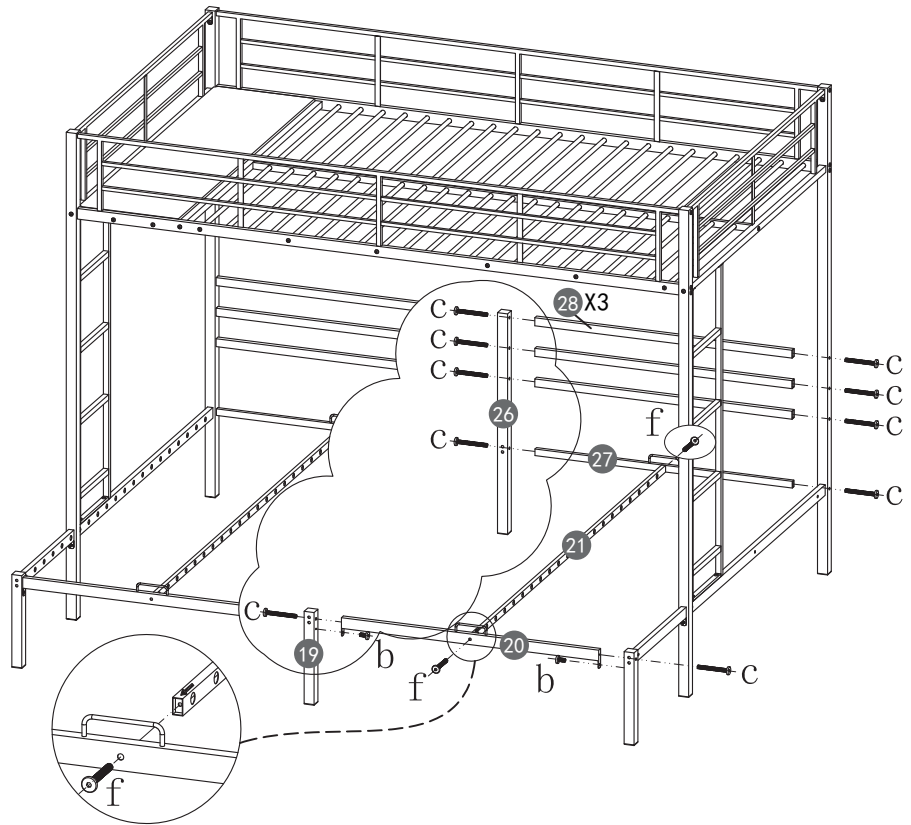

STEP 10:

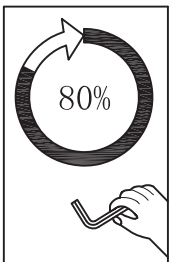

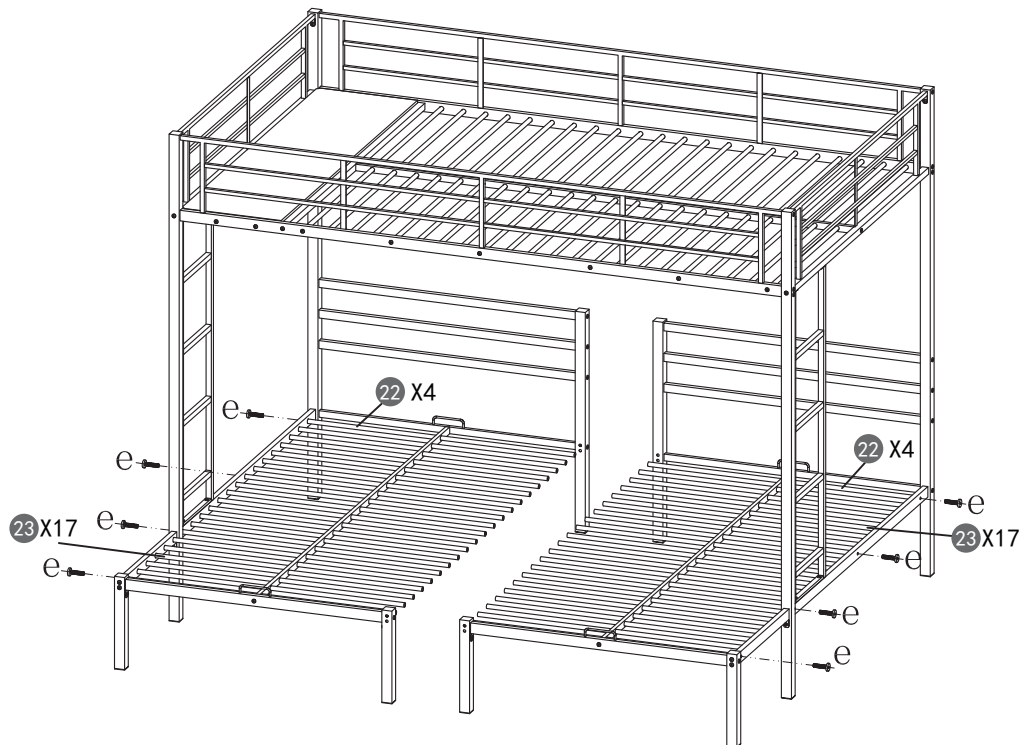

e	x8
	
M6*20mm	

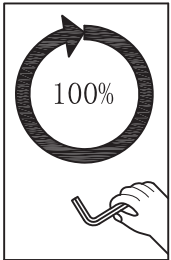

STEP 11:

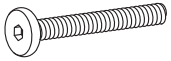

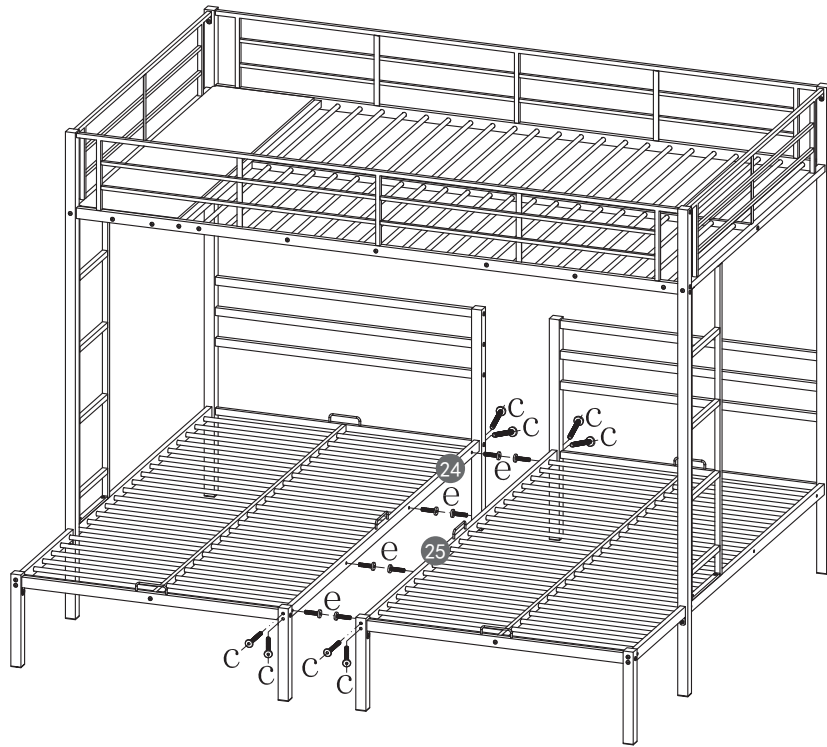

c	x8
	
M6*60mm	
e	x8
	
M6*20mm	

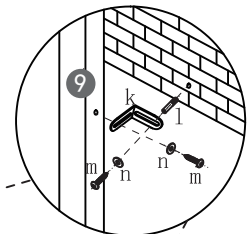

STEP 12:

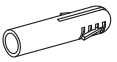
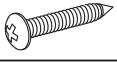

k	x2
	
l	x2
	
φ 6	
m	x4
	
M4x30mm	
n	x4
	
φ 13*1	

