





TZ706-1200-Installation

STEP 1

NO.	Parts	Quantity
①		1
②		2
③		1
④		1

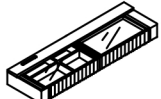
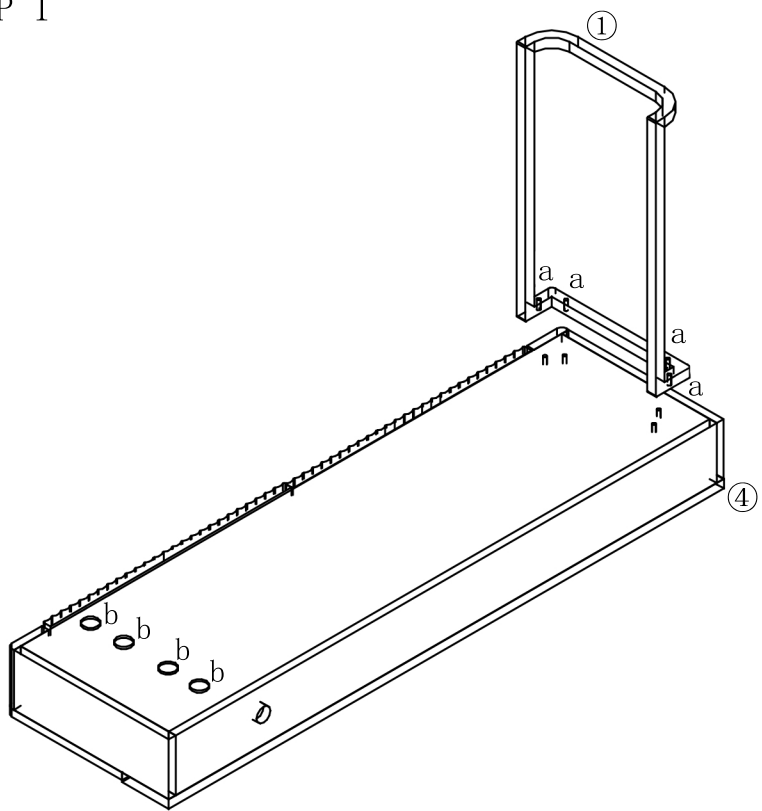

STEP 2

NO.	Parts	Quantity
a		M6*35=4
b		4

