

Owner Manual

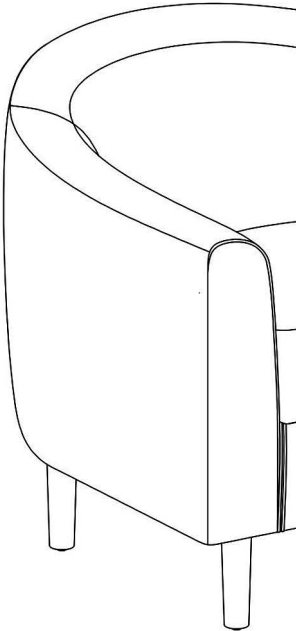

WARRANTY

We strive to offer high quality product and we also try our best to satisfy each customer that order from us, no matter on products or services as needed. Each customer receives a record of their order, such as the order number or item receipt. For any items that are out of warranty period, you may still be able to purchase the replacement parts from our company if they are available.



MAINTENANCE AND WARNING

Please read the manual thoroughly
before you start installing.

Please keep the product away from
sharp object.

Packaging and small parts may have
chocking hazard, please keep them away
from children and pets.

Please clean the product according to each
clean code, check the product description
for more information.

Please keep the product away from
fire.

If you have any other questions, please
contact us, we will be glad to help you out.

If the product is placed under direct
sunlight, the pattern or color might fade
away overtime.

Check the product periodically to make
sure everything is secured and tightened.

Always use proper tools for installation.

Do not jump on the product.



Around 15 min

PRODUCT DESCRIPTION



Wrapped in a high-cotton content linen fabric, this chair offers a breathable, soft-touch surface that stays gentle on skin, even after hours of use.

Filled with resilient foam and artificial fibers, the seat delivers exceptional comfort with bounce-back support that doesn't flatten over time.

The integrated armrests are positioned for natural arm support, offering both visual unity and physical ease during relaxation.

Designed to follow your body's contours, the wide and angled backrest promotes posture while offering a cocoon-like wraparound feel.

Sturdy wooden legs ground the chair with dependable stability, ensuring this stylish piece holds up beautifully over time.

EXPLODED VIEW

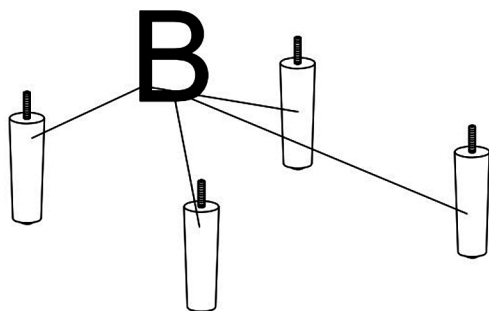
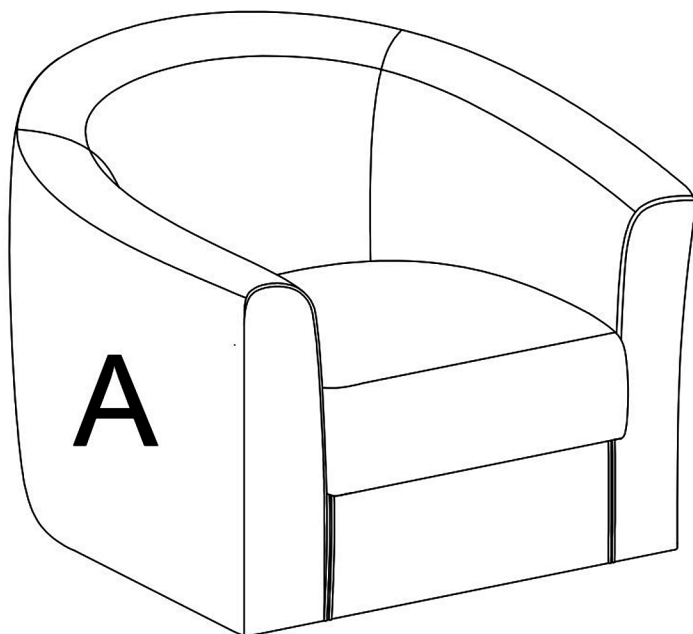

PARTS

A*1

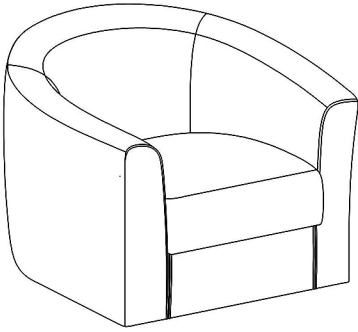

Seat

B*4



Wood Legs

HARDWARE

TOOL LIST

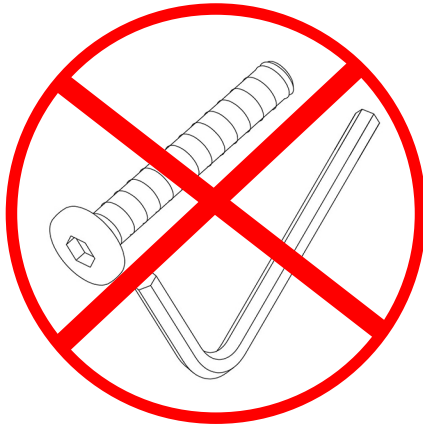

Please be aware:

This chair does not come with extra accessories fittings (such as bolts, washers etc.)

step 1

Twist in all chair legs (B) into the chair frame (A) as shown, make sure they are fully tightened.

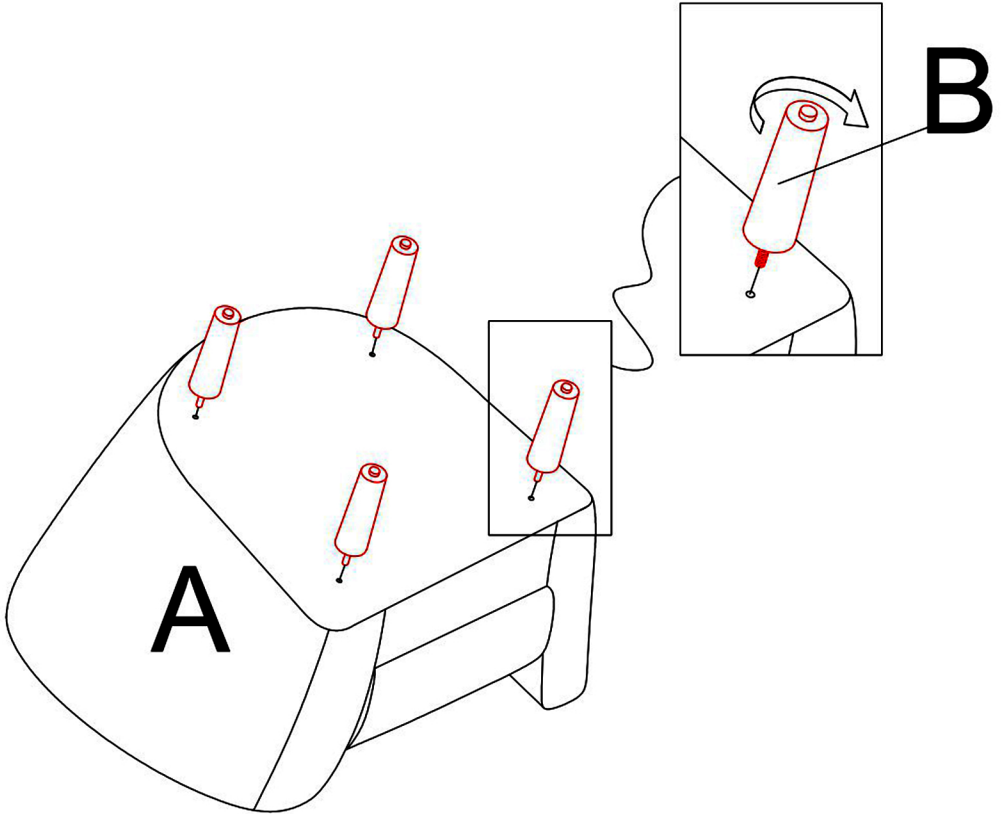

step 2

Congratulations! You have finished the assembly, thank you again for choosing our product! Please enjoy!

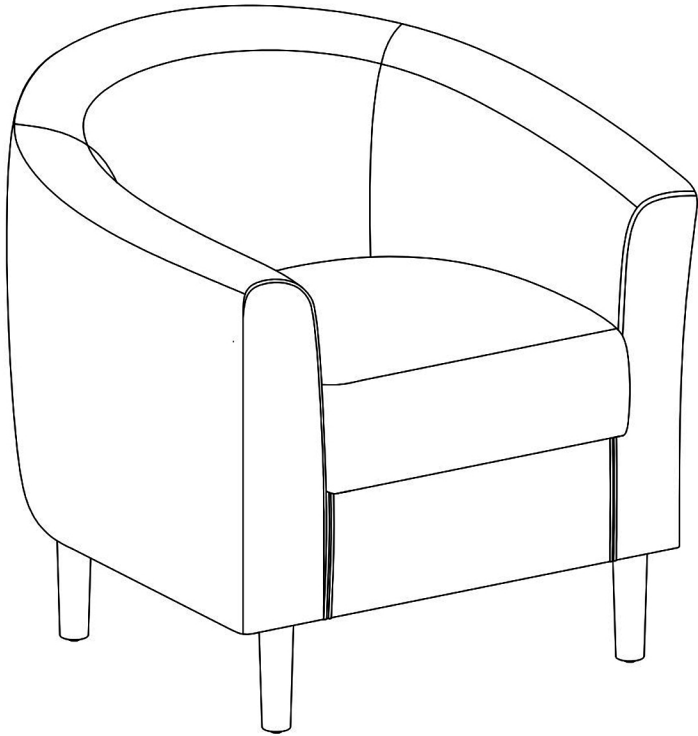

step 3

Please note: the legs of the chair can be adjusted by twisting the leveler on the tip of the legs as shown, it can help you use this chair on ground that is not flat, please check before you use the chair.

