

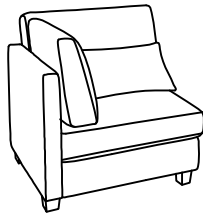

















ASSEMBLY INSTRUCTION



PARTS LIST

 A x1	 C x1	 E x1	 F x1	 G x1	 H x1	 I x1	<p>J</p>  <ul style="list-style-type: none">  x1  x4  x8  x8  x10  x8  x2  x1  x1  x2
--	---	---	---	---	---	---	---

ASSEMBLY INSTRUCTION

Step1:

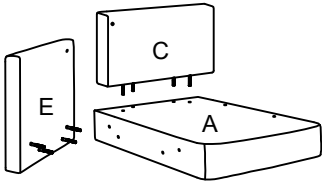

Step2: Screw the wooden legs clockwise. Gentle
Reminder: There are only 2 holes for the legs at the bottom of the corner seats because the other 2 legs should be installed to the arms of the sofa.

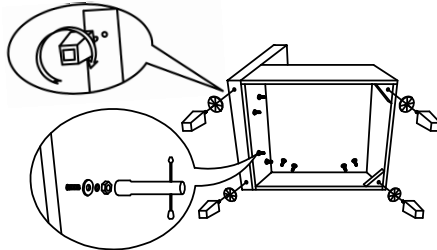

Step3: Pls kindly fixed the armrest and backrest by Allen key.

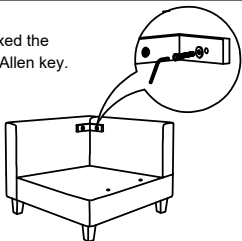



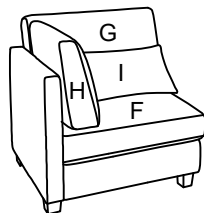



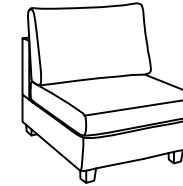

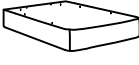

Step4



ASSEMBLY INSTRUCTION



PARTS LIST

 B x1	 D x1	 F x1	 G x1	<p>K</p>  <ul style="list-style-type: none">  x4  x4  x4  x4  x4  x2
---	---	---	---	---

ASSEMBLY INSTRUCTION

Mx1

Step1

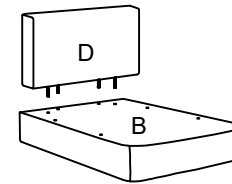

Step2

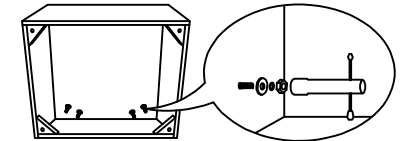

Step3

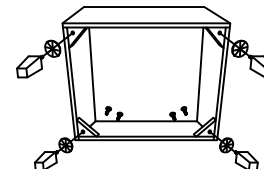

Step4

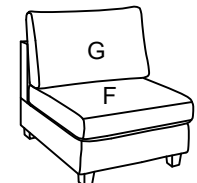

PARTS

Quantity

SECTIONAL SOFA



-L

X1



-R

X1



-A

X2



-O

X2



U-shaped pendant

X6

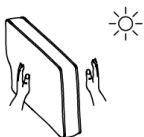
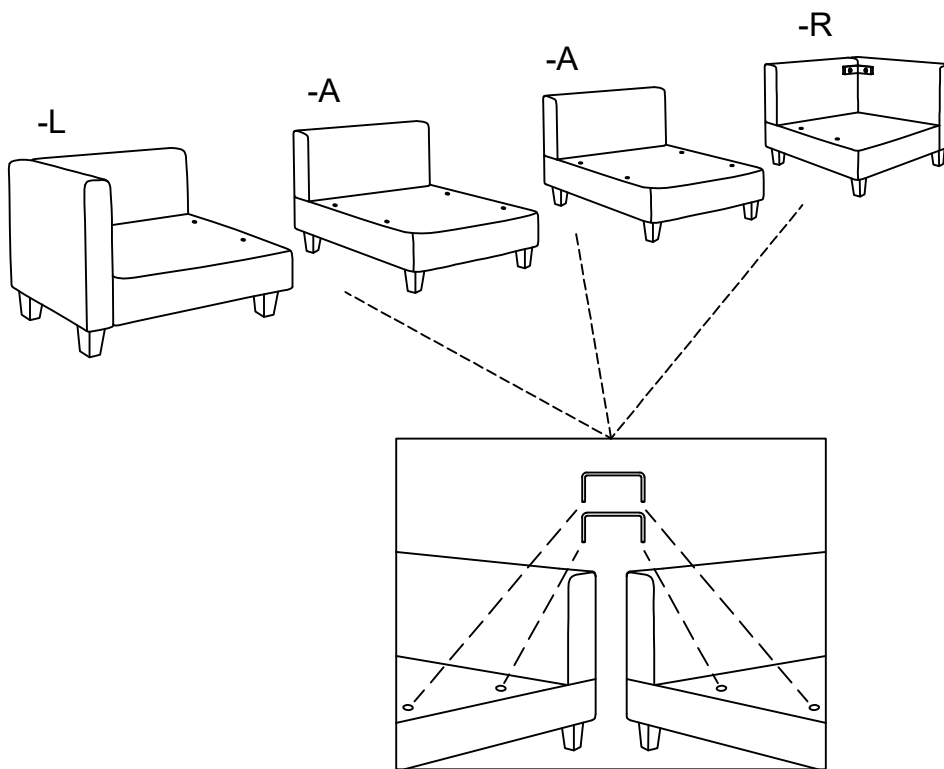
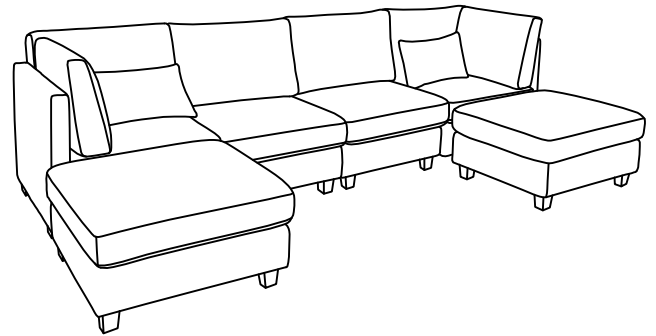

Tap the backrest and place it in the sunlight to fluff it up quickly, it takes about 10 minutes for the backrest to fluff up.

Pay attention: Because of the compressed packaging, there may be some creases on the cover. Please do not worry, pat it several times and wait for moments, the crease will be more natural and will not affect the use.

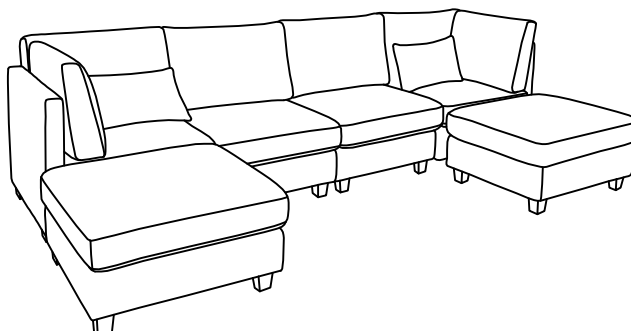





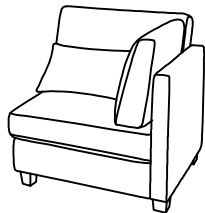











ASSEMBLY INSTRUCTION

ITEM NO.: -R



PARTS LIST

 A x1	 C x1	 E x1	 F x1	 G x1	 H x1	 I x1	J  x8  x1  x4  x10  x8  x8  x2  x1  x1  x2
--	---	---	---	---	---	---	---

ASSEMBLY INSTRUCTION

Step1

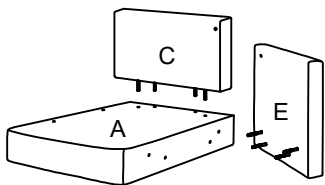

Step2: Screw the wooden legs clockwise. Gentle
Reminder: There are only 2 holes for the legs at the bottom of the corner seats because the other 2 legs should be installed to the arms of the sofa.

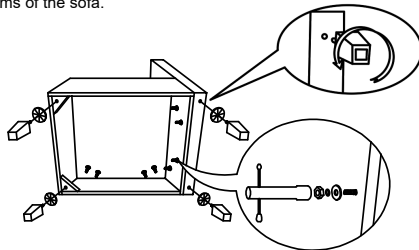

Step3:

Pls kindly fixed the armrest and backrest by Allen key.

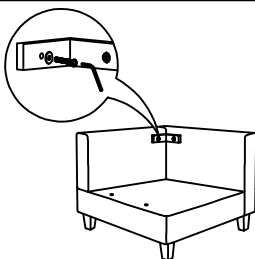

Step4







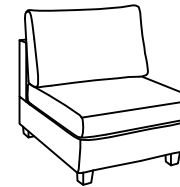



ASSEMBLY INSTRUCTION

ITEM NO.: -A



PARTS LIST

 B x1	 D x1	 F x1	 G x1	K  x4  x4  x4  x4  x2
---	---	---	---	--

ASSEMBLY INSTRUCTION

Mx1

Step1

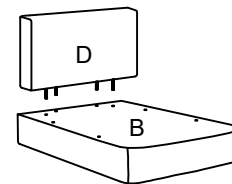

Step2

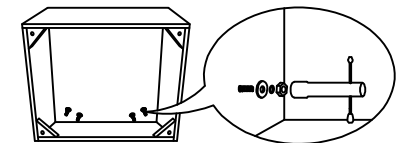

Step3

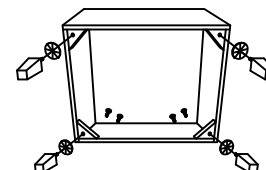

Step4

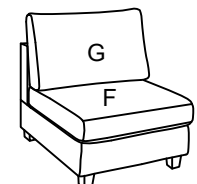

PARTS

Quantity

SECTIONALSOFA



-L

X1



-R

X1



-A

X2



-O

X2

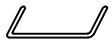

U-shaped pendant

X6

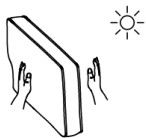
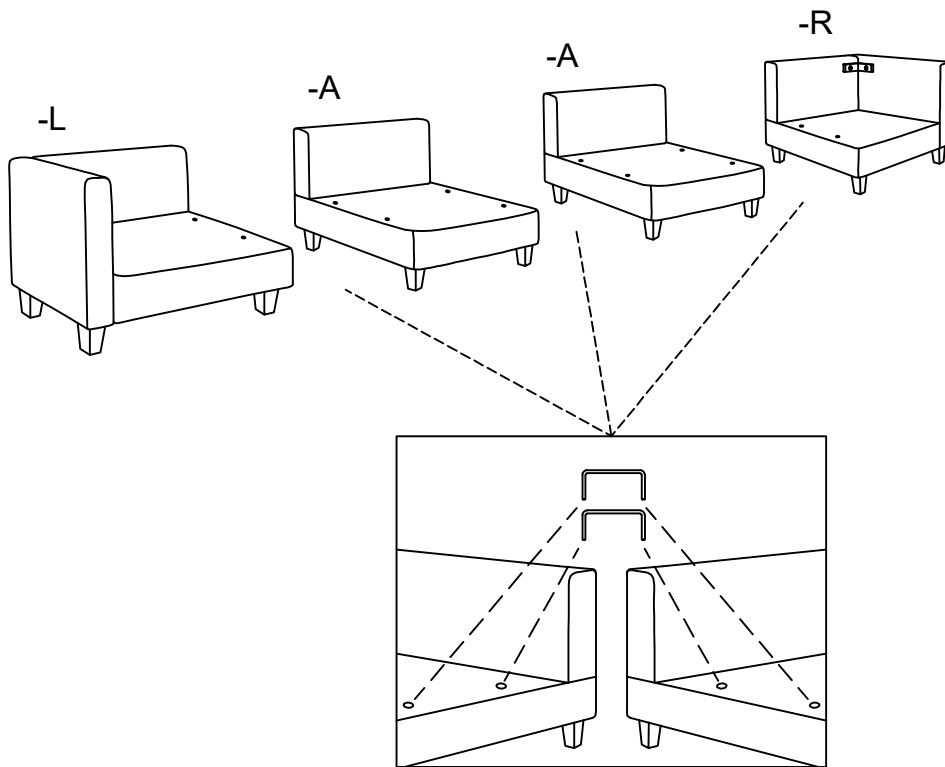
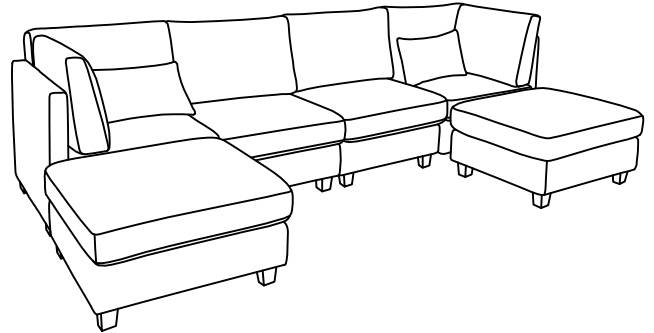

Tap the backrest and place it in the sunlight to fluff it up quickly, it takes about 10 minutes for the backrest to fluff up.

Pay attention: Because of the compressed packaging, there may be some creases on the cover. Please do not worry, pat it several times and wait for moments, the crease will be more natural and will not affect the use.

