

ASSEMBLY INSTRUCTIONS

EEI-5015

V1.09.15.21

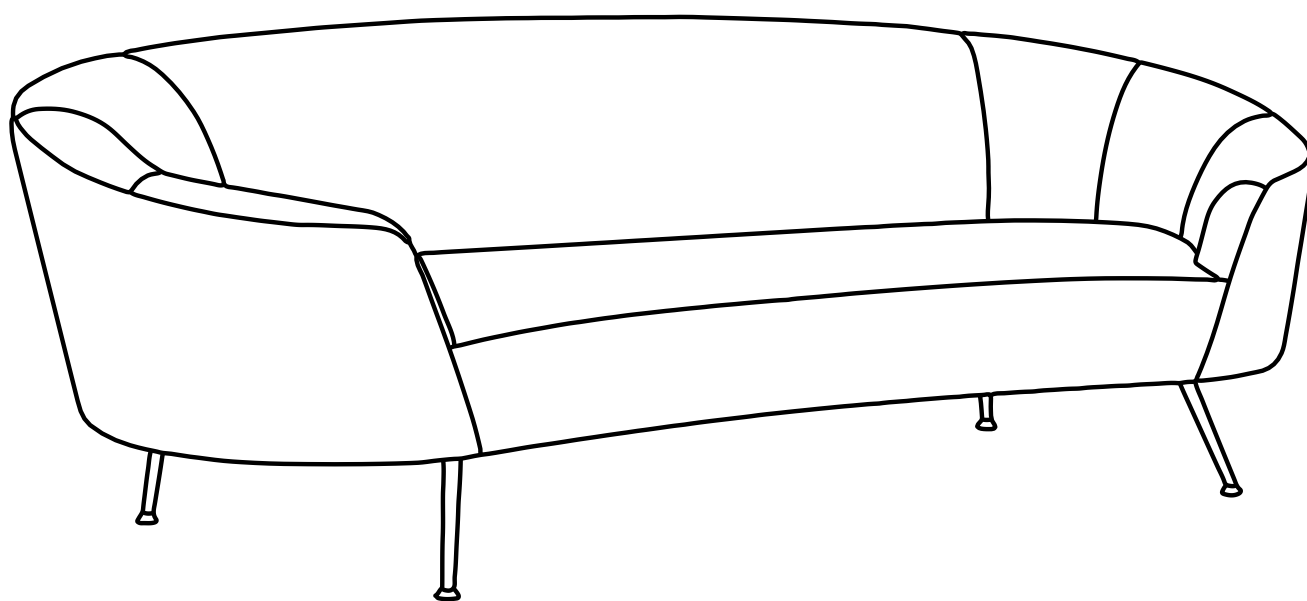

Questions? Contact us!

609.256.9000 • cs@modway.com
www.modway.com

***modway**

Let's get started!

*modway



Read through all of the instructions before starting



Care instructions are listed in the last step of this manual



Approx. 30 minutes assembly time



Make sure you have all parts and components before discarding any packing materials



2 people recommended for assembly

Only use hand tools to assemble this item. Do not use power tools. Do not tighten bolts or screws completely until all hardware is lined up and inserted into the holes.

Do not over-tighten screws and bolts to avoid stripping the hardware or cracking the item.

Assemble your item on a flat, carpeted area, with plenty of space to work. This will prevent damage and scratches to your floors or the item while you're assembling the product.



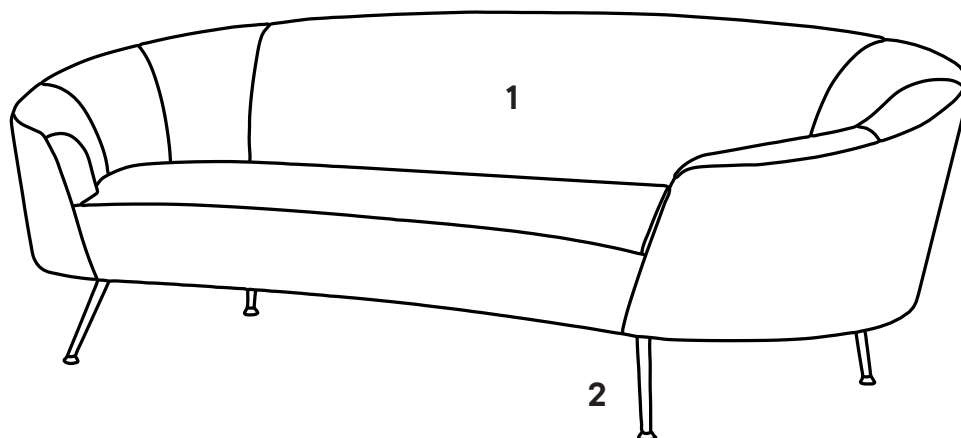

Keep all components and packaging out of reach of children or animals to avoid risk of choking or suffocation.

Furniture components:

1	Sofa Body	x1
2	Sofa Legs	x4

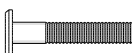

Provided hardware:

A		Bolt M8x30mm	x12
B		Spring Washers M8	x12
C		Flat Washers M8	x12
D		Allen Key	x1

Wait!

Missing parts or hardware? Need assistance?

Contact us before returning your item. We're here to help!
609.256.9000 • cs@modway.com

Step 1

COMPONENTS

- 1 Sofa Body x1
- 2 Sofa Legs x4

BOTTOM

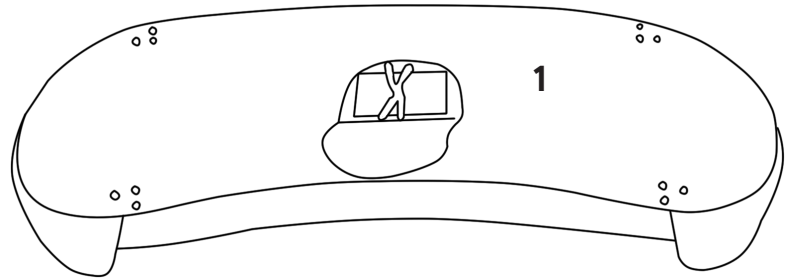

Unzip the bottom facing pocket to locate 4 Legs (2) & Hardware pack.

Step 2

HARDWARE

- A Bolt M8x30mm x12
- B Spring Washers M8 x12
- C Flat Washers M8 x12
- D Allen Key x1

COMPONENTS

- 2 Sofa Legs x4

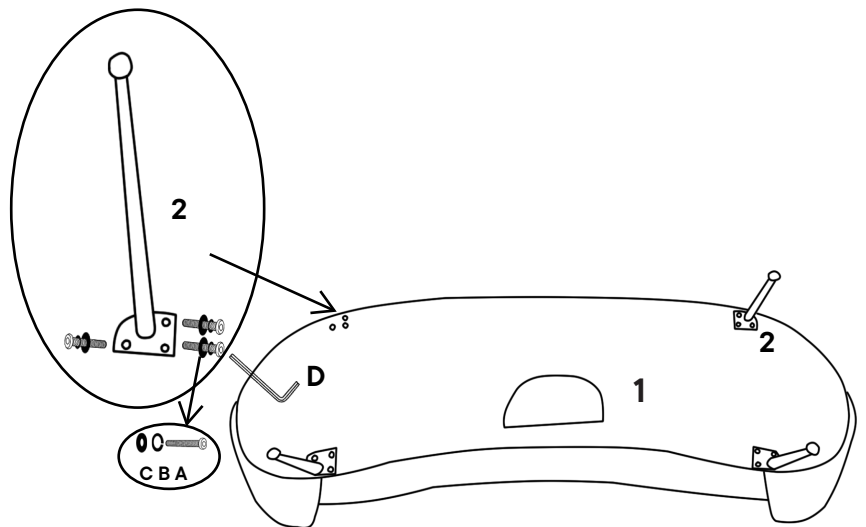

Great job!

Your sofa is complete and ready to enjoy.

♥ CARING FOR YOUR ITEM

Indoor use only.

Not contract grade.

Spot clean using a non-abrasive cloth and a mild cleaner.

Never use harsh chemicals, as they could damage the finish or integrity of the item.

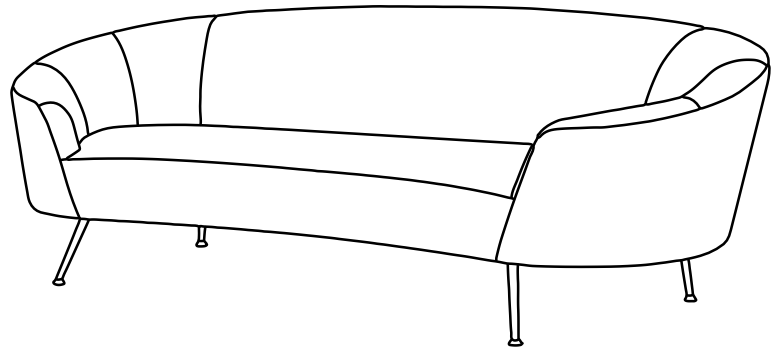

CONNECT WITH US!   

Tag us [@modway_furniture](#) and [#modway](#) for a chance to be featured.