

# ASSEMBLY AND INSTALLATION INSTRUCTIONS

Item No: HWXDD006-2-GY

**WARNING: TO AVOID RISK OF ELECTRICAL SHOCK, BE SURE TO SHUT OFF POWER WHILE INSTALLING OR SERVICING THIS FIXTURE.**

## NOTES:

1. Before installing, consult local electrical codes for wiring and grounding requirements.
2. Read and save these instructions.
3. Always switch off the electricity supply and allow to cool for 10 minutes before changing the light bulbs.

## 2-LIGHT OUTDOOR CEILING LIGHT

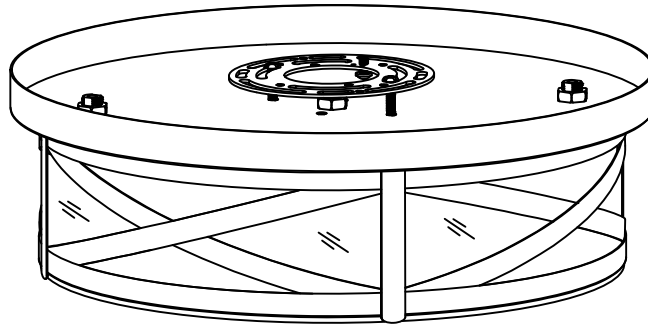

## TOOLS REQUIRED

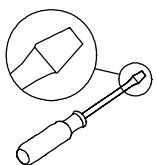

Flathead Screwdriver

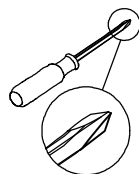

Phillips Screwdriver



Ladder

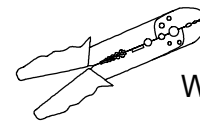

Wire Strippers



Pliers



Electrical Tape

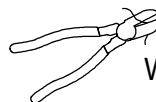

Wire Cutters



Safety Glasses

## PREPARATION

Before beginning assembly of product, make sure all parts are present. Compare parts with package contents list and hardware contents list. If any part is missing or damaged, do not attempt to assemble the product. When the lamp is not installed finish, please don't throw away the package, so as not to leave the parts in the package.

# PART LIST AND HARDWARE LIST

PIECE	DESCRIPTION	QUANTITY
A	Wire nut	3
B	Mounting plate	1
C	Outlet box screw	2
D	Green ground screw	1
E	Decorative Nuts	2
F	Fixture body	1
G	Glass	1
H	Hardware	1
I	Induction ring	1

## INSTALLATION

1. Connect the mounting plate (B) to the junction box with the outlet box screw (C), and then fix it.
2. Connect the power circuit grounding wire (green or bare copper wire) to the fixture grounding wire, Black to (black) and white to (white).
3. Insert the fixture body (F) into the mounting plate (B). Lock with 2 decorative nuts (E)
4. Install two E26 LED A-type bulbs on the lamp holder (not included)
5. Insert into glass (G). Hardware (H) is locked with an induction ring (I)

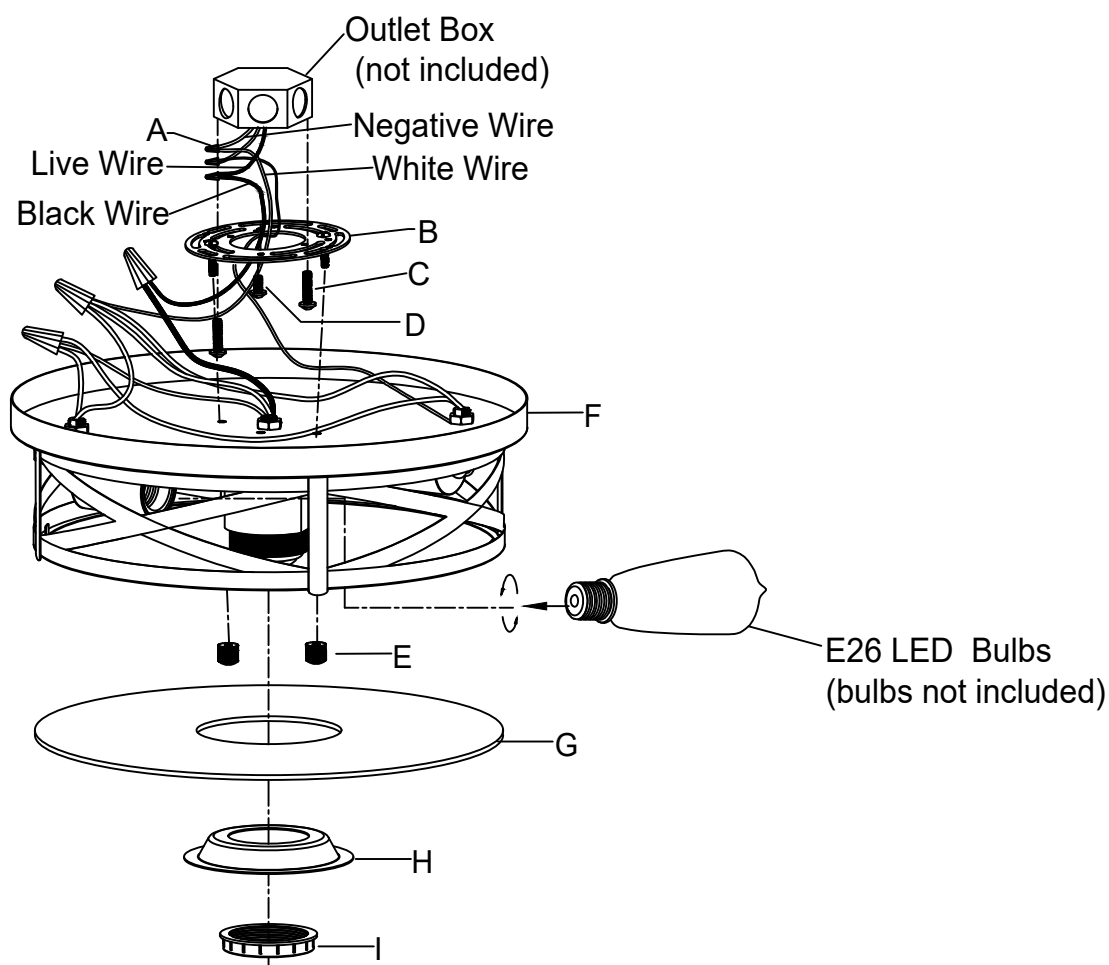

If you have any issues with use this product, please email us. Be sure to include your order number and photos of the issues. This will help us provide you with faster support and solve your problem.

 [lighting\\_service@outlook.com](mailto:lighting_service@outlook.com)

# Function and Operation

Note: when power is first applied, the light will come on for about 15 sec. to allow the circuit into stability.

The sensor has 2 knobs to adjust operation mode and shut off delay time and sensitivity .( See FIG.1)

Modes	Sensitivity knob Position	Timer knob Position	Operation LUX	Explanation
Stand-by Mode	Between L to H	Test, 5s to 3min	Day & Night	STATE WHEN POWER IS TURN ON: If you have turned off the power for a long period of time and upon restoring power to the fixture, the light will turn on in 2seconds and remain on for approximately 15 seconds regardless of motion. Then it will entered the Auto Mode or Test Mode (Depends on how Mode Switch set)
Test Mode	Between L to H	Test	Day & Night	SENSITIVITY ADJUSTMENT: Allows you to adjust the sensitivity of motion detector to a desired level at day or night. When motion stops, the light will turn off in about 5 seconds.
Auto Mode	Between L to H	Between 5s to 3min	Night only	NORMAL MOTION DETECTION MODE: Motion detector turns your light on automatically after sensing moving heat sources in its coverage area at dusk ,and stays on as long as motion is detected .When motion stops, light will remain on for the predetermined time you set (5seconds to 3 minutes continuously adjustable),and then turn off automatically.
Manual Override Mode with Auto Reset	Between L to H	Between 5s to 3min	Night only	MANUAL ON AND OFF WITE AUTO RESET: Allows you to turn on and off your light by using the existing wall switch ,regardless the presence of motion .The unit will rest itself back to Auto Mode after 5.5 hours .It is also possible you de-activate the feature manually by the existing wall switch. (See FIG.2)

FIG.1

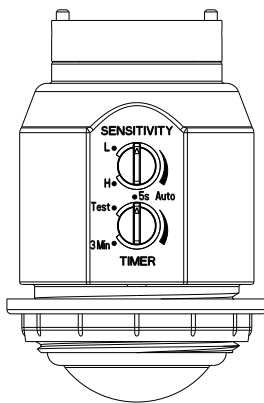

## Sensitivity Knob:

The sensitivity knob adjusts the amount of heat that is required to activate the unit. Set the knob to "H" position to obtain the maximum sensitivity, and set the knob to "L" position to indicate the minimum sensitivity. To set to a desired level of sensitivity.

1. Set the TIMER knob to the TEST position and the sensitivity knob to "H" position.
2. Walk through the coverage area and note the location where you are when light turns on 100%. The light will turn off in about 5 seconds . Keep in mind that a better sensitivity is achieved by walking across the coverage area ,not walking towards or away from the motion sensor .
- 3.Set the knob to "H" position to obtain higher sensitivity, and set the knob to "L" position to indicate the minimum sensitivity. If the sensitivity knob is set to "H" position, you will reach about 25 feet.

## Timer Knob:

At Auto Mode , light turns on automatically after sensing a motion at its coverage area and stays on as long as motion is detected .When motion stops ,the light will remain on until the selected period of time is over. The Timer knob selects the amount of time the light remains on after motion has stopped .knob to "5S" for 5seconds, knob to "3Min" for 3 minutes, 5seconds to 3 minutes continuously adjustable.

## Manual Override Mode with Auto Reset :

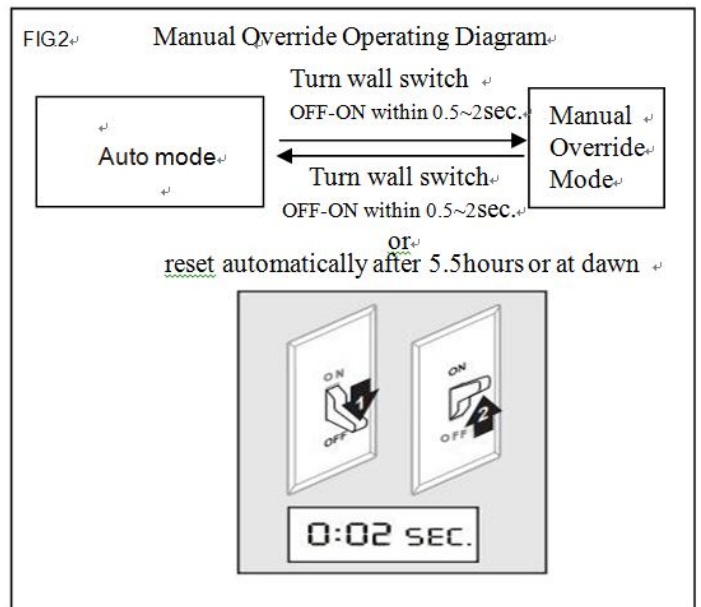

## Troubleshooting

SYMPTOM	Possible Cause	Solution
The light doesn't work in Test Mode	Wall switch or circuit breaker is off The wiring is mistake	Turn on a switch or circuit breaker. Check wire connections.
In Auto mode , the lighting fixture does not turn on when there is motion	Wall switch or circuit breaker is off	Turn on a switch or circuit breaker.
	Light bulb may be dead.	Test the light bulb in a known working light fixture
	Light bulb is loose.	Tighten the light bulb in the socket.
	Incorrect or loose wire connections.	Check wire connections.
	Too much sunlight is shining into the Dusk-to-Dawn sensor in the early evening.	Relocate fixture away from a western facing wall.
	Too much light is shining onto the Dusk-to-Dawn sensor due to another light source, such as a street lamp or other light fixture.	Eliminate or turn off other light source, block other light source from shining onto Dusk-to-Dawn sensor, or relocate fixture.
In Auto mode , the lighting fixture stays on at 100% brightness continuously.	False triggering caused by a heat source, such as street or sidewalk traffic, a heater or dryer vent, or air conditioning vent, or heated swimming pool.	Eliminate heat source or relocate fixture
The lighting fixture comes on for no apparent reason	False triggering caused by a heat source, such as street or sidewalk traffic, a heater or dryer vent, or air conditioning vent, or heated swimming pool.	Eliminate heat source or relocate fixture
The lighting fixture comes on during the daytime or too early in the evening	The fixture may be installed in a shaded area, such as under a porch or eave, preventing daylight from shining onto the Dusk-to-Dawn sensor.	Relocate the fixture
In Manual override, the light stays on after dawn	The ambient light level is too low	Relocate the fixture