

Purchase Date: / / Order/Customer Reference Number:

We stand behind our brand and the quality of the items we sell. Replacement parts or products can be requested within the 1-year warranty period. Proof of purchase must be provided. This includes the date of the purchase as well as photos of the product defect. Photos are used to determine the cause of the defect and to provide future quality control. The request will be reviewed, and replacement pieces will be sent at our discretion.

STEEL FIREWOOD LOG HOOP

Review all assembly and care information before using this product. Save this manual for future reference.



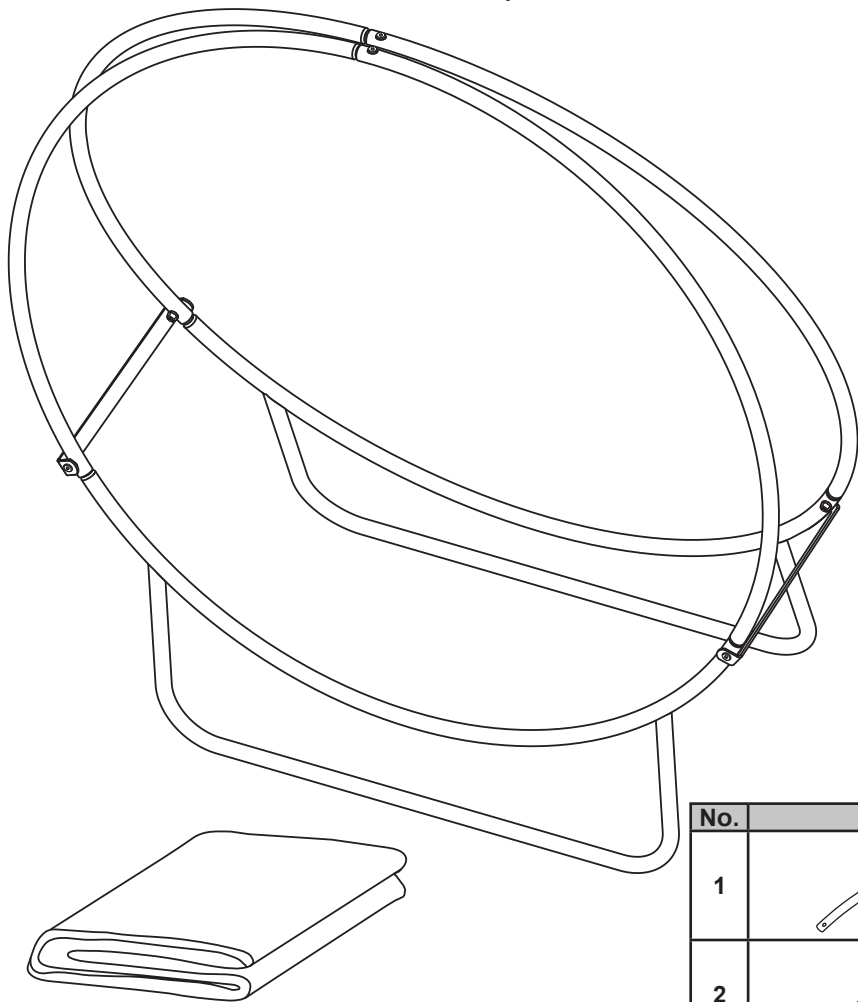



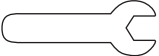

Assemble components on a soft, clean surface to avoid damaging the finish.

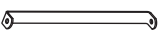

Inspect packaging to ensure all parts are accounted for before disposing of packing materials.
Save the packing slip.

| INCLUDED TOOLS | |
|---|---------|
|  | Hex Key |
|  | Spanner |

⚠ WARNING ⚠
CHOKING HAZARD — This item contains small parts that can be swallowed. Keep children and pets away during assembly.

| No. | PARTS | QTY. |
|-----|---|------|
| 1 |  Left Tube | 2 |
| 2 |  Right Tube | 2 |
| 3 |  Base Tube | 2 |
| 4 |  Side Bracket | 2 |
| 5 |  Top Bracket | 1 |
| 6 |  M6x30mm Bolt | 6 |
| 7 |  Lock Nut | 6 |
| 8 |  Washer | 6 |
| 9 |  Cover | 1 |

ASSEMBLY

Review all information and understand assembly before beginning.

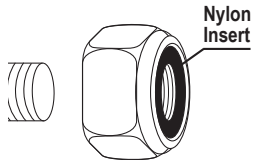

! IMPORTANT: Lock nuts must be installed with the nylon insert on the outside. Tools are required to fully tighten lock nuts, failure to properly tighten the lock nuts may result in product malfunction or personal injury.

STEP 1

- 1: 2
- 2: 2
- 3: 2

x2

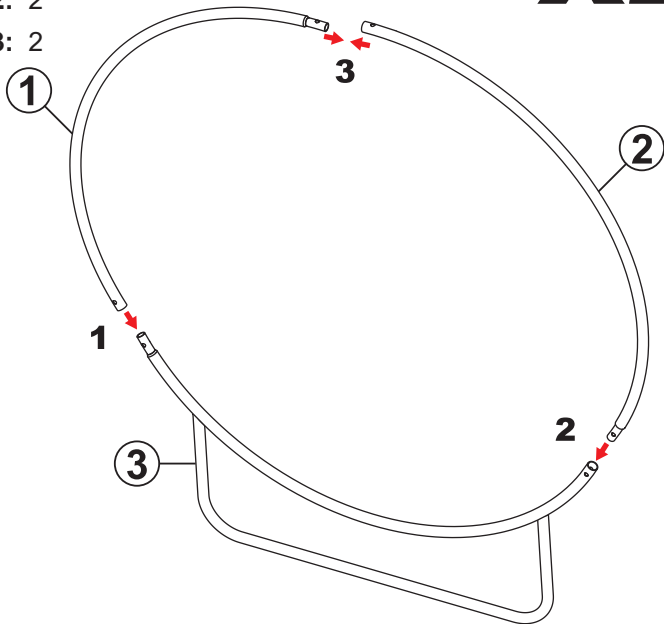

Ensuring mounting holes align, install Left Tube (1) and Right Tube (2) onto Base Tube (3).

Insert the top of the left tube into the right tube.

NOTE: Minor force may be necessary to align these tubes.

Repeat to assemble the remaining tubes.

STEP 2

- 5: 1
- 6: 2
- 7: 2
- 8: 2

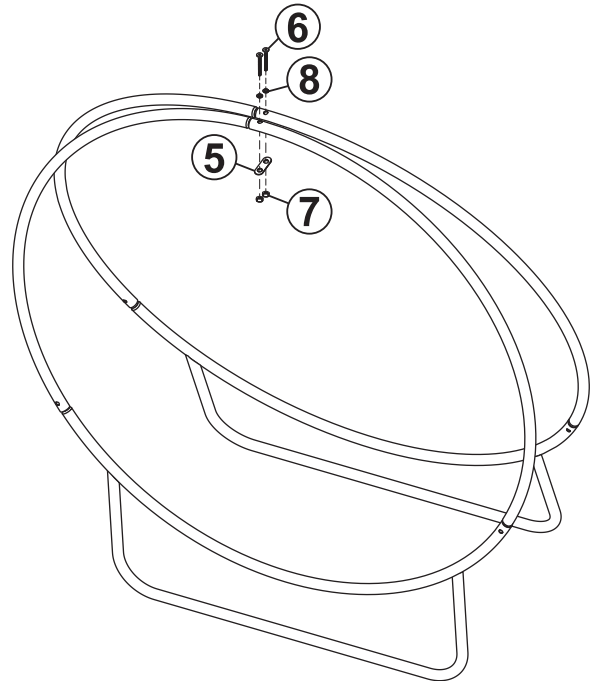

Install Top Bracket (5) underneath the top mounting holes by hand-tightening Bolt (6), Washer (8), and Lock Nut (7). **Do not fully tighten hardware.**

STEP 3

- 4: 1
- 6: 4
- 7: 4
- 8: 4

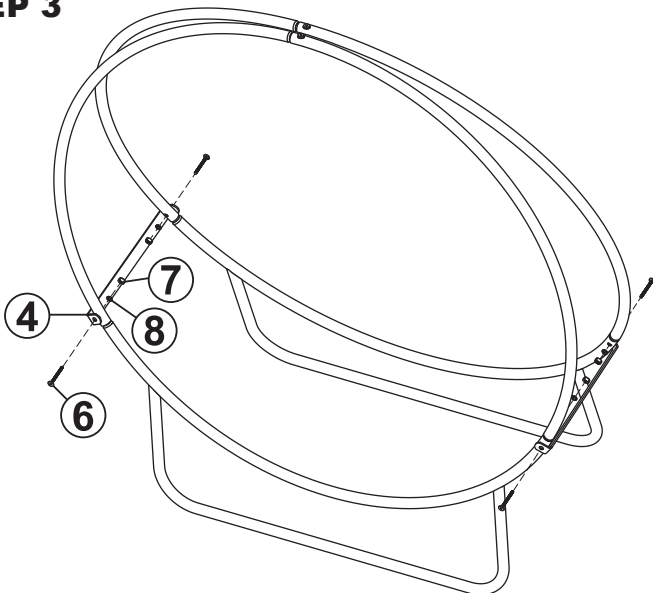

Install Side Brackets (4) over the sides of the log rack by hand-tightening Bolts (6), Washers (8), and Lock Nuts (7).

After all hardware has been loosely installed, finish tightening all lock nuts.

SAFETY STATEMENTS & WARNINGS

- Place log rack on a hard, dry surface.
- Ensure fittings are tight before use. Periodically check and tighten hardware as necessary.
- Protect the unit from outdoor elements with the included cover.
- Do not allow children to play with or around the log rack.

Any modification to the product or failure to follow recommended care will void the product warranty.

If you experience issues with assembly or the product was damaged during transit, please contact our customer service team through one of the methods mentioned at the top of page 1. Please have the item number and order information ready to expedite response time.

WARNING!

Manufacturer and seller expressly disclaim any and all liability from personal injury, property damage or loss, whether direct or indirect, or incidental, resulting from the incorrect attachment, improper use, inadequate maintenance, or neglect of this product.