

USER MANUAL

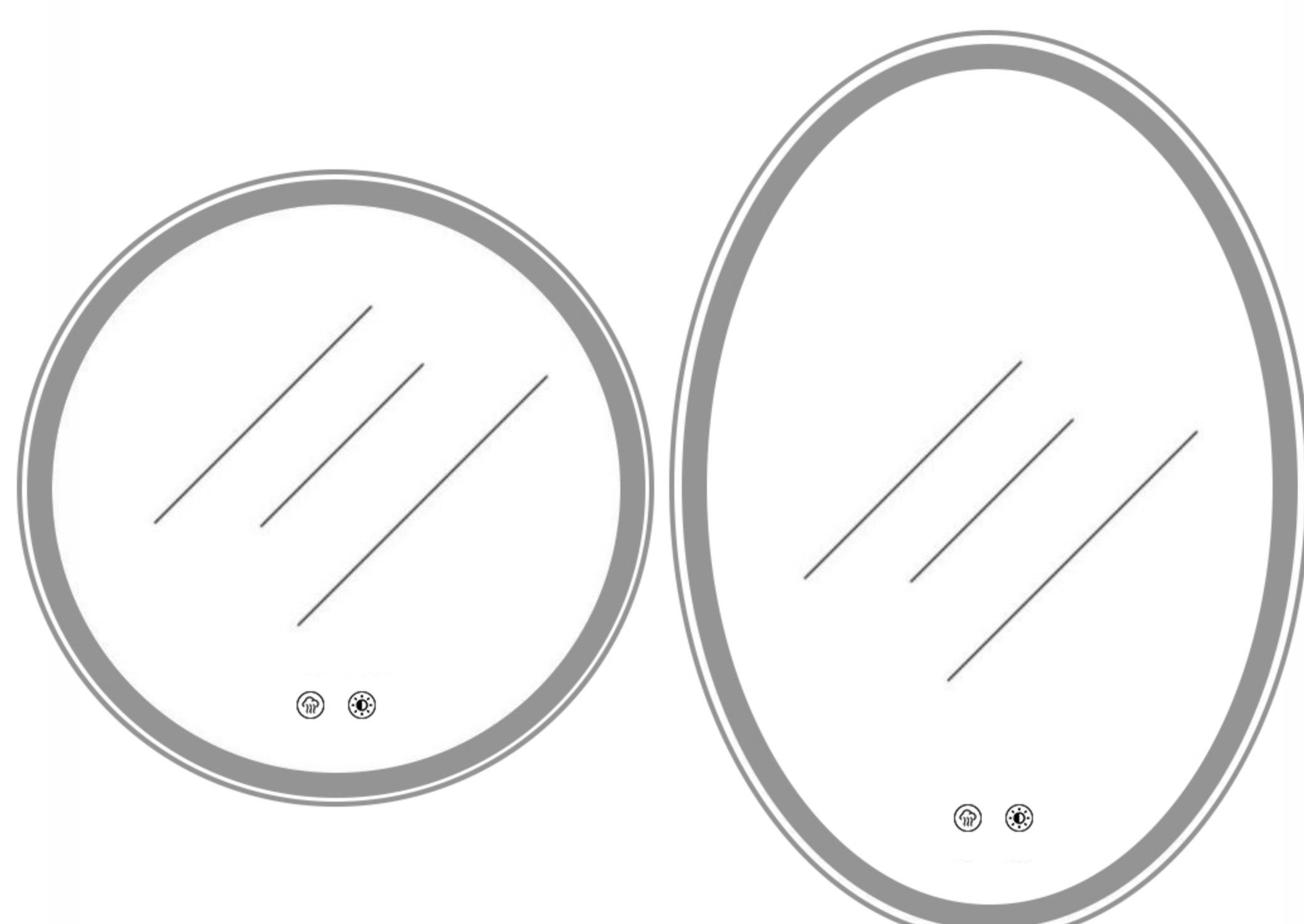

LED BATHROOM MIRROR

INSTALLATION GUIDE

PACKAGE CONTENTS

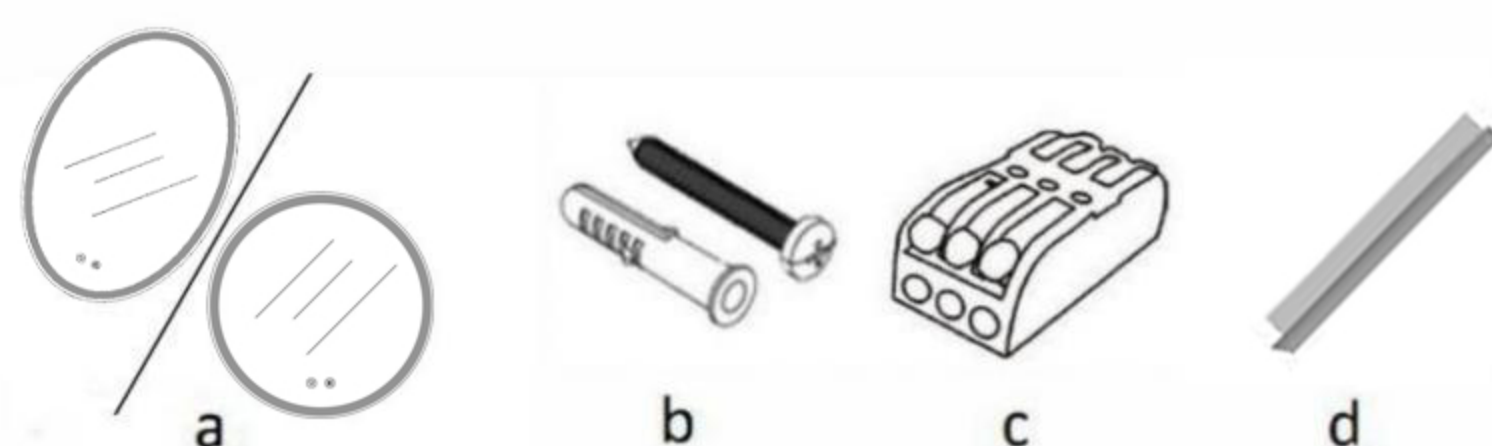

Piece	Description	Quantity	Piece	Description	Quantity
a	LED Mirror	1	d	Brackets	1
b	Wall Anchors & Screws	4			
c	Wire Connector	1			

TOOLS REQUIRED

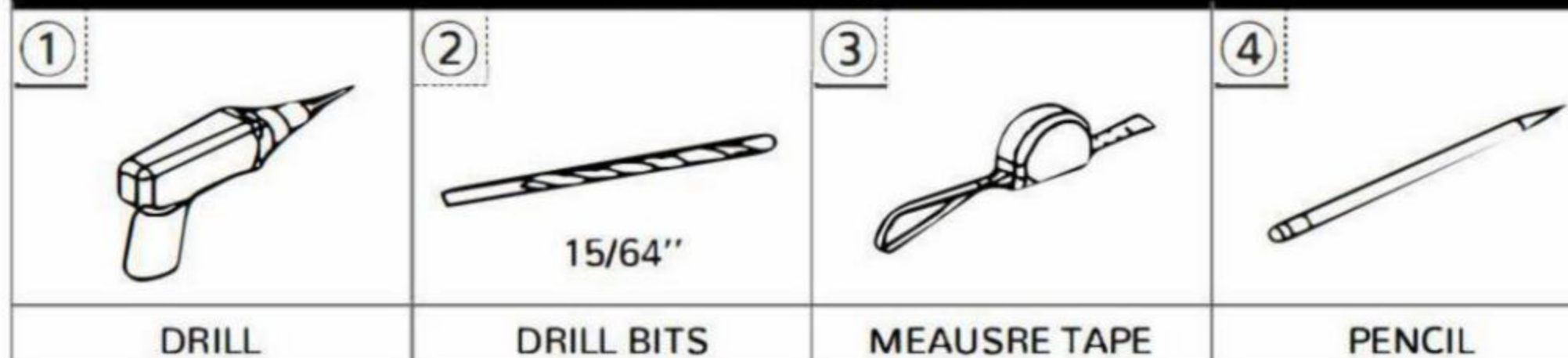

MIRROR STYLE

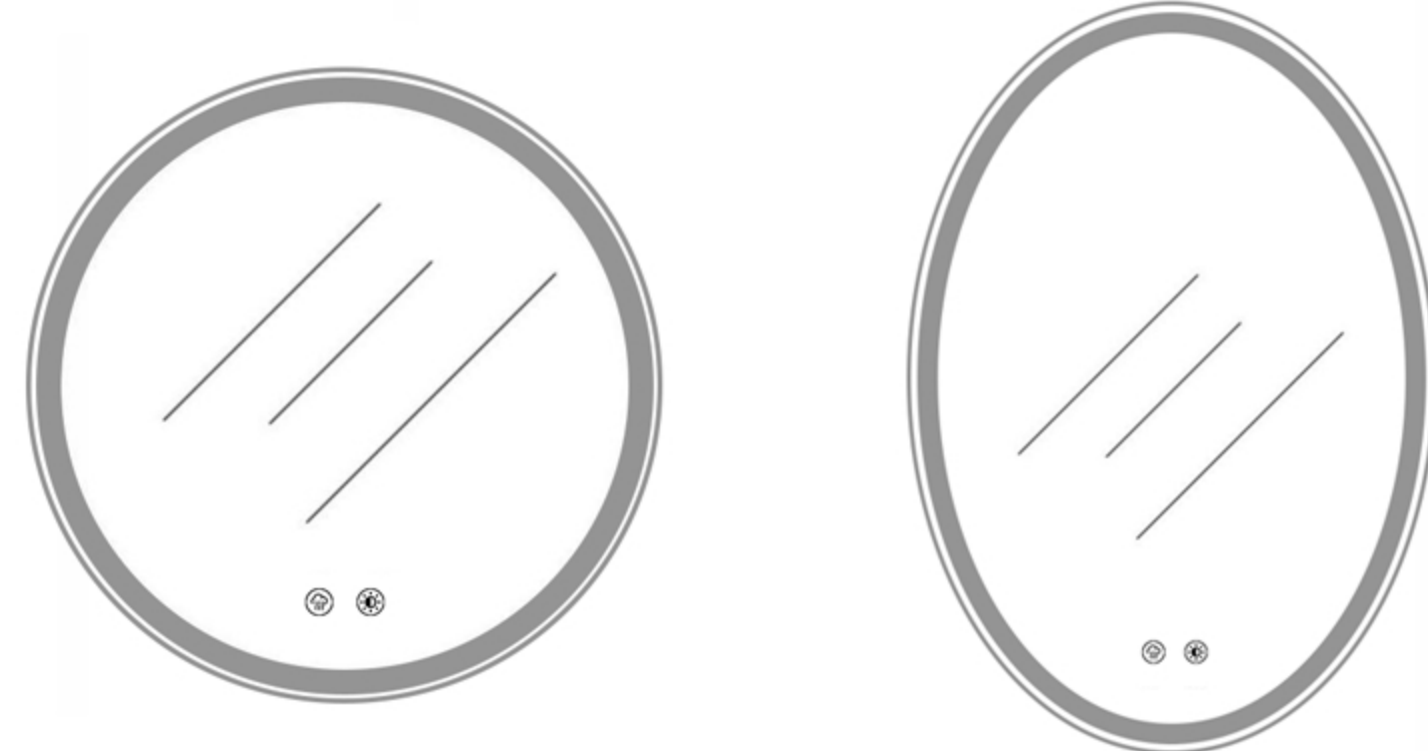

1

INSTALLATION GUIDE

Specifications:

Mount Type	Wall Mounted
Power Source	Hardwired / Plug-in
Switch Type	Touch On / Off
Voltage	110 - 130V
Wattage	60W
Color Temperature	3000K - 6000K
Color of the Light	Warm / Neutral / Cold White
Memory Function	Yes
Defog Function	Yes
CRI	≥95+
Life Span	≥50,000H
IP Rate	IP54
Safety Compliance	ETL

Thank You For Choosing Our Appliance!

Warranty:

5-Year Warranty for Quality-Related Issues: Customer can contact us for refund or replacement if it is defective during normal use due to faulty materials, craft or function within 5 years after purchase or delivery. (Notice: Photos or videos that can prove the problem of the product itself must be provided as the basis for judgment.)

The Exclusions/Limitations:

- Damage is caused by not carrying out the recommended appliance maintenance
- Accidental damage, faults caused by negligent use or care, misuse, neglect, careless operation or handling of the appliance is not specified in our operation manual
- Use the device for any other purpose besides regular household use
- Faulty installation

6

OPERATION INSTRUCTION

Color Temperature Adjustment:

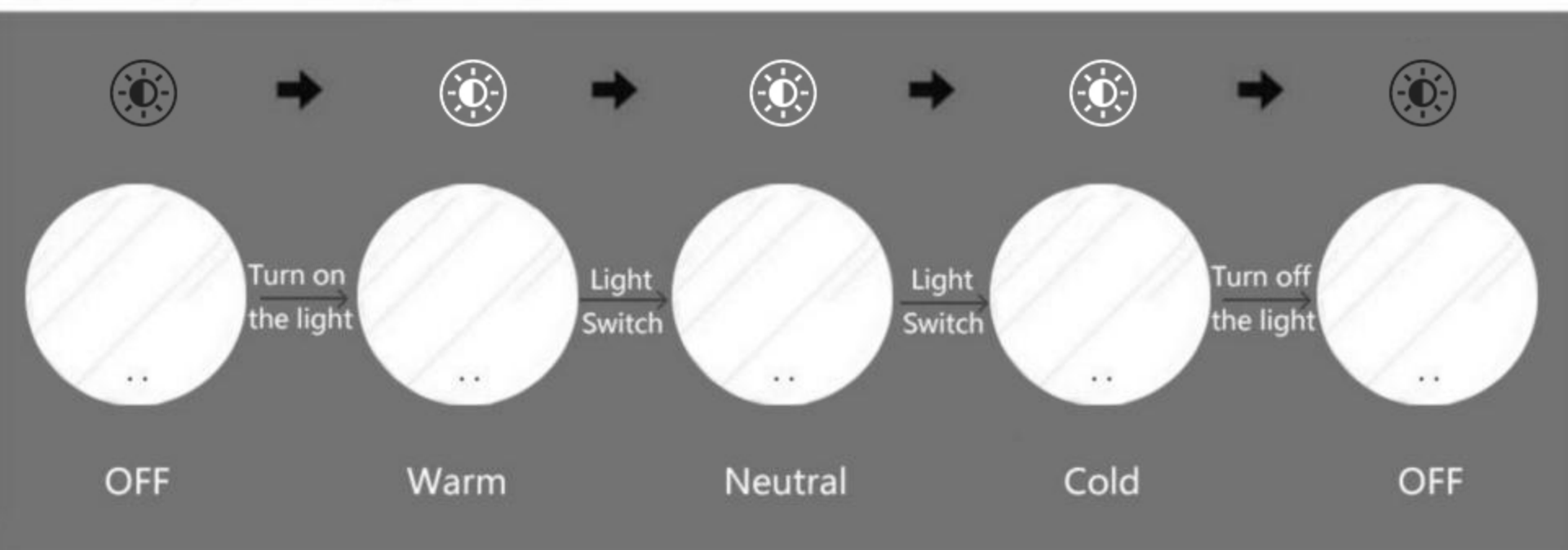

Brightness Adjustment:



Anti-fog Function

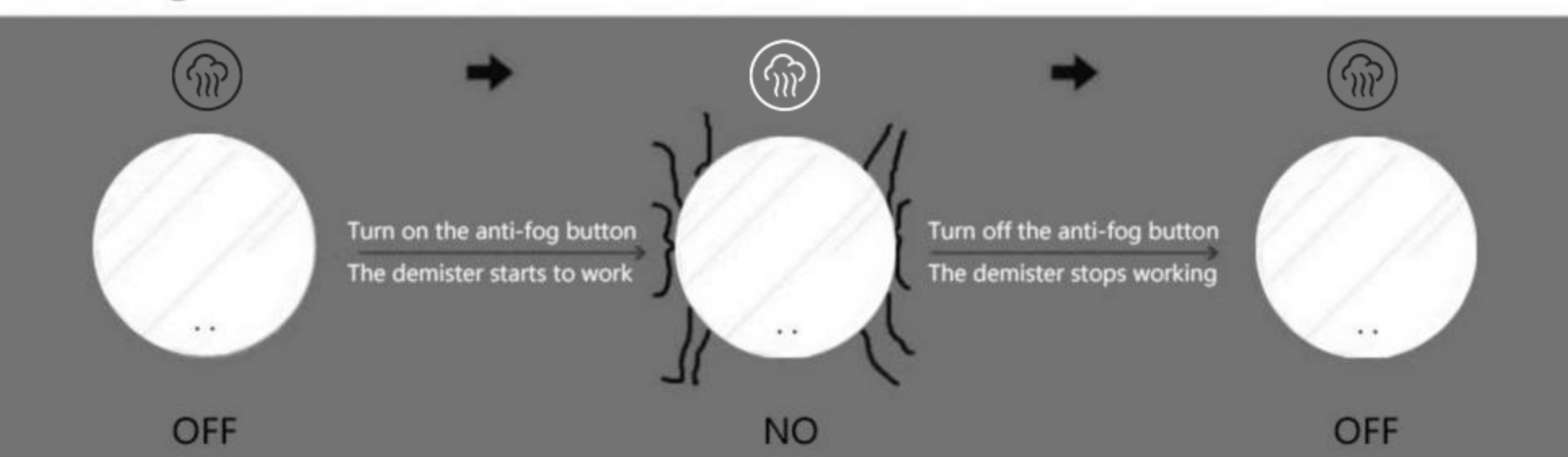

▲ **Memory Function:** Set the brightness and color temperature as you like, and your setting will be memorized after 10s. The next time restart, it will assume the previously used state.

▲ **Automatic Delayed Power-off Function:** The power will be turned off one hour later automatically if you forget to close it, energy saving.

2

INSTALLATION GUIDE

IMPORTANT SAFETY INSTRUCTIONS

Pre-Installation

PLANNING INSTALLATION

Compare all parts with the part listed in the package contents section if any part appears missing or damaged. Do not install and use this light. Contact customer service.

WARNING: RISK OF ELECTRICAL SHOCK

- Turn off electrical power at fuse or circuit breaker box before wiring fixture to the power supply.
- Turn off the power when you perform any maintenance.
- Please verify that the supply voltage is correct by comparing it with the luminaire label information.
- Make all electrical and grounded connections under the National Electrical Code, and any applicable local code requirement.
- All wiring connections should be capped with UL approved wire connectors.

CAUTION: RISK OF INJURY

- Wear gloves and safety glasses when removing luminaire from the carton, installing, servicing or performing maintenance.
- Avoid direct eye exposure to the light source while it is on.
- Account for small parts and destroy packing material, as these may be hazardous to children.
- Mirrors are heavy. Get assistance lifting the unit. This installation is most straightforward when performed by two people.

WARNING: RISK OF BURN

- Allow fixture to cool before handling. Do not touch enclosure or light source.
- Follow all lamp manufacturer's warnings, recommendations and restrictions for driver type, burning position, mounting locations/methods, replacement, and recycling.

CAUTION: RISK OF FIRE

- Keep combustible and other materials that can burn away from luminaire and lamp/lens.

5

INSTALLATION GUIDE

ELECTRIC CONNECTIONS

ALL WIRING SHOULD BE DONE BY A QUALIFIED LICENCED ELECTRICIAN

- ▲ **WARNING:** Shut off power before wiring the mirror.
- ▲ **WARNING:** An Electrical option mirror must be wired to a 20 Amp GFI (Ground Fault Interrupter) protected circuit when used in bathrooms and all other locations required by the National Electric Code.
- ▲ **WARNING:** This mirror must be connected to a grounded, metal permanent wiring system or an equipment-grounding conductor must be run with the circuit conductors and connected to the equipment grounding terminal or lead on the mirror.
- ▲ **CAUTION:** Requires 120 VAC 20 Amp 6FI protected circuit.

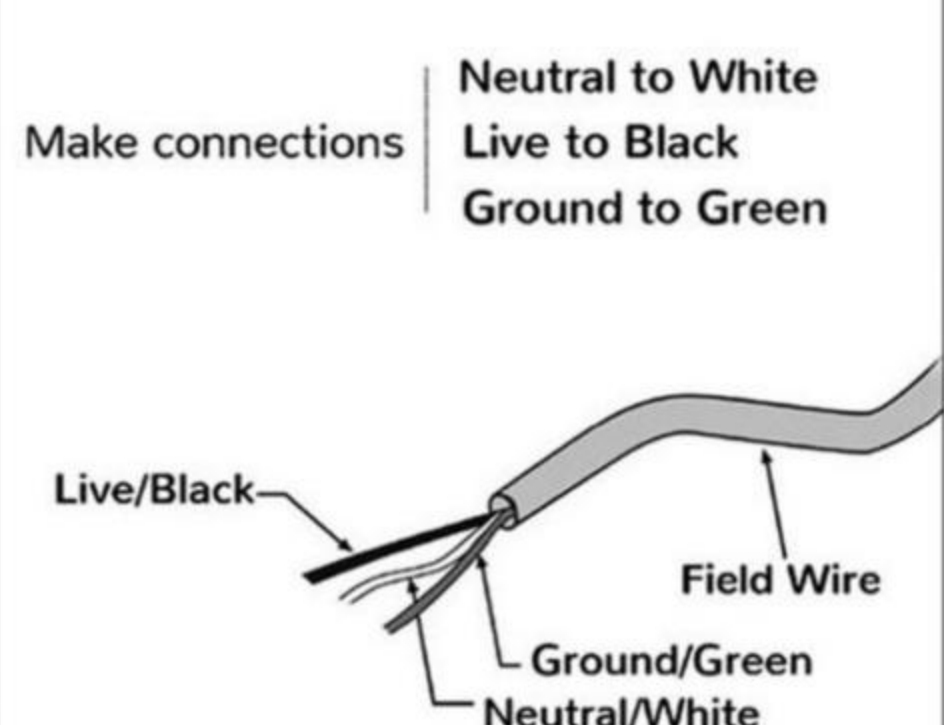
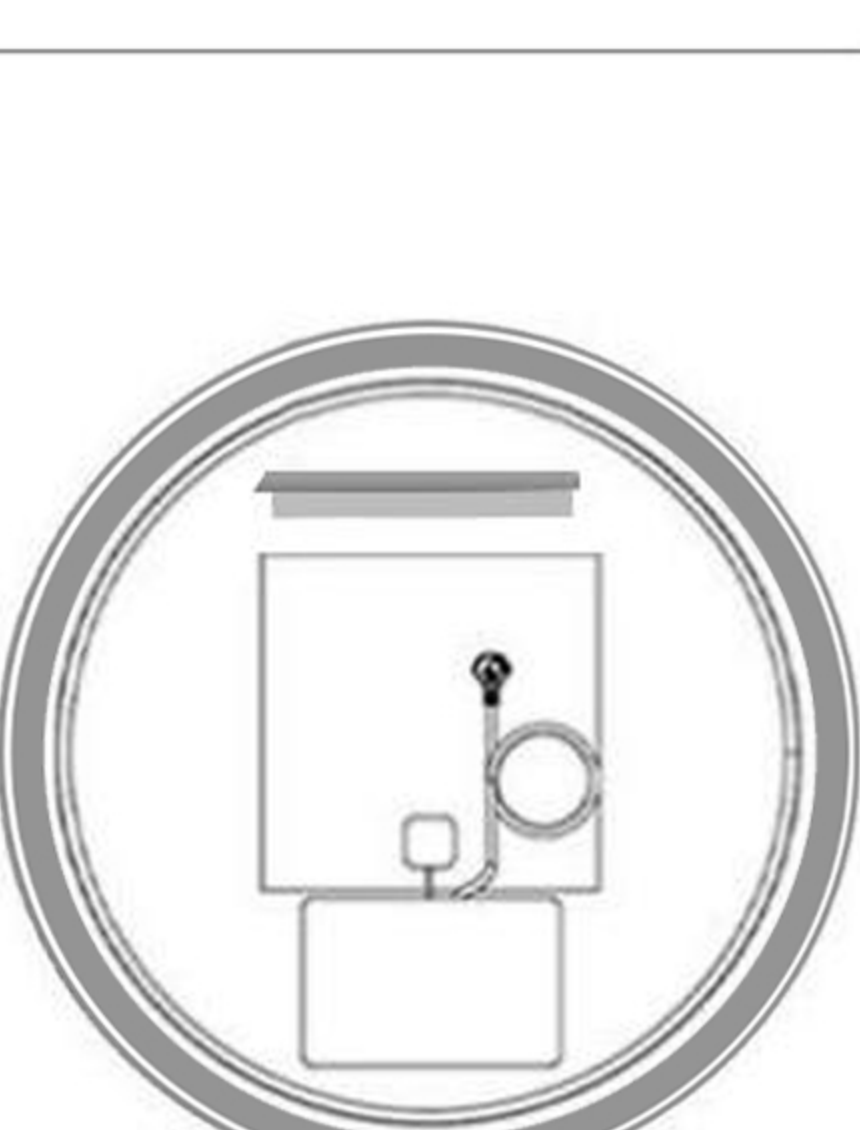

3

INSTALLATION GUIDE

INSTALLATION INSTRUCTIONS

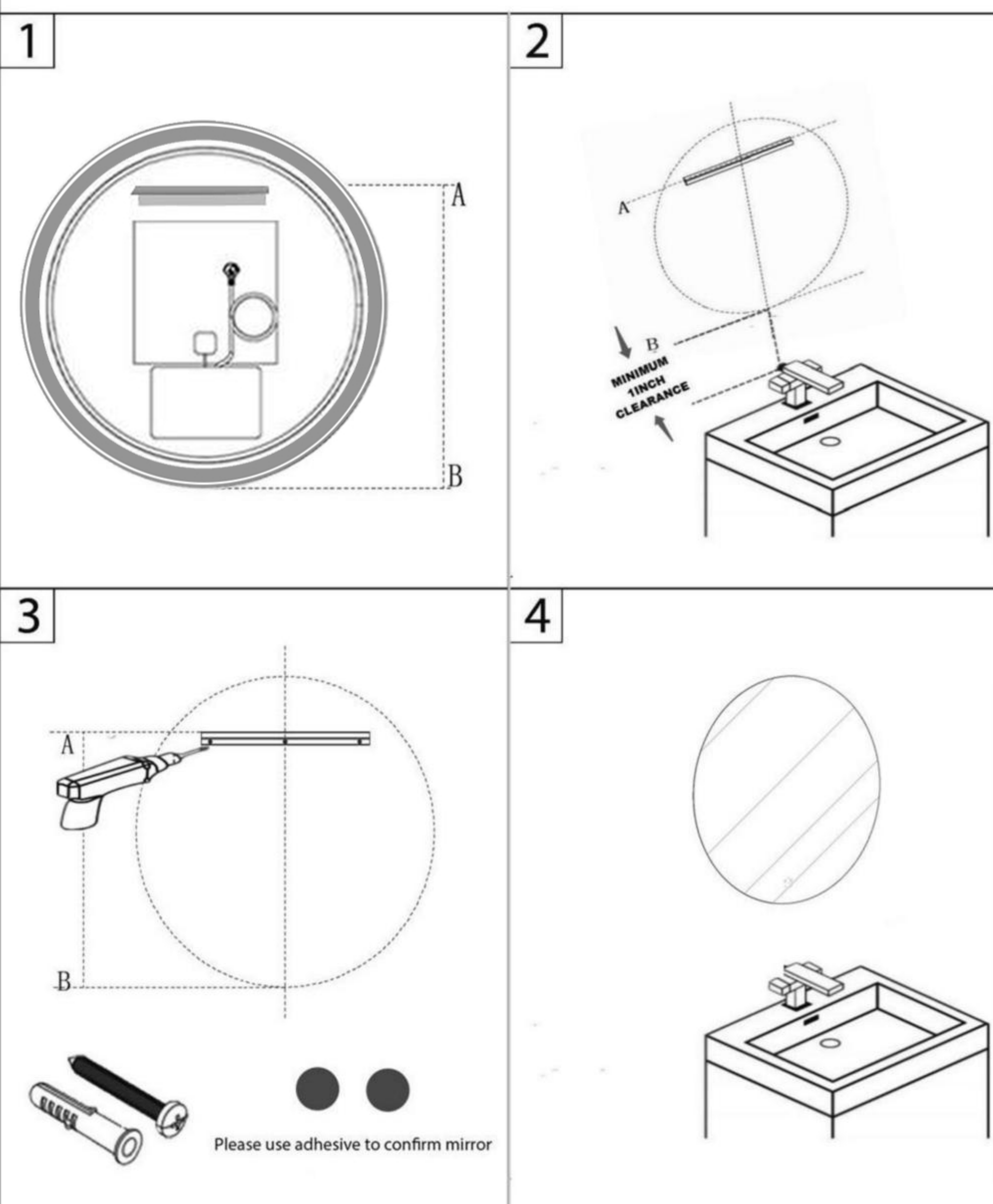

4