

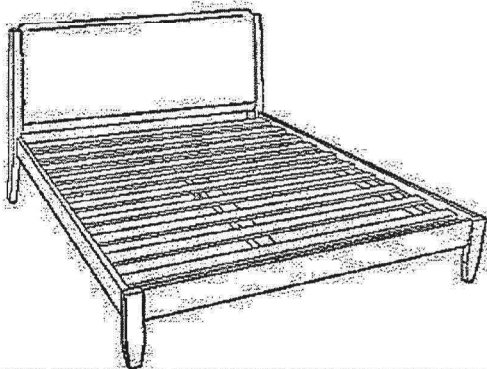











## FULLY SET UP



## HARDWARE LIST

NO	DESCRIPTION	QTY
A	M5 x 300mm JCBC 	4pcs
B	M5 x 50mm JCBC 	4pcs
C	M5 x 60mm JCBC 	6pcs
D	M5 x 20mm JCBC 	2pcs
E	BARREL NUT 	10pcs
F	Ø8 x 35mm WOOD DOWEL 	8pcs
G	WOODEN PLUG 	14 pcs
H	M4 X 25mm SCREW (Q / K) 	34pcs
	M4 X 25mm SCREW (D / F) 	31pcs
I	ALLENKEY 	1pcs
J	ADJUSTER 	3pcs

### STEP 1

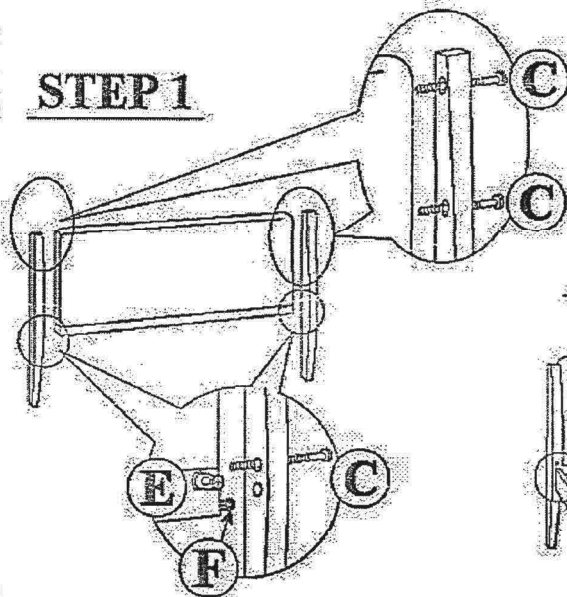

### STEP 2

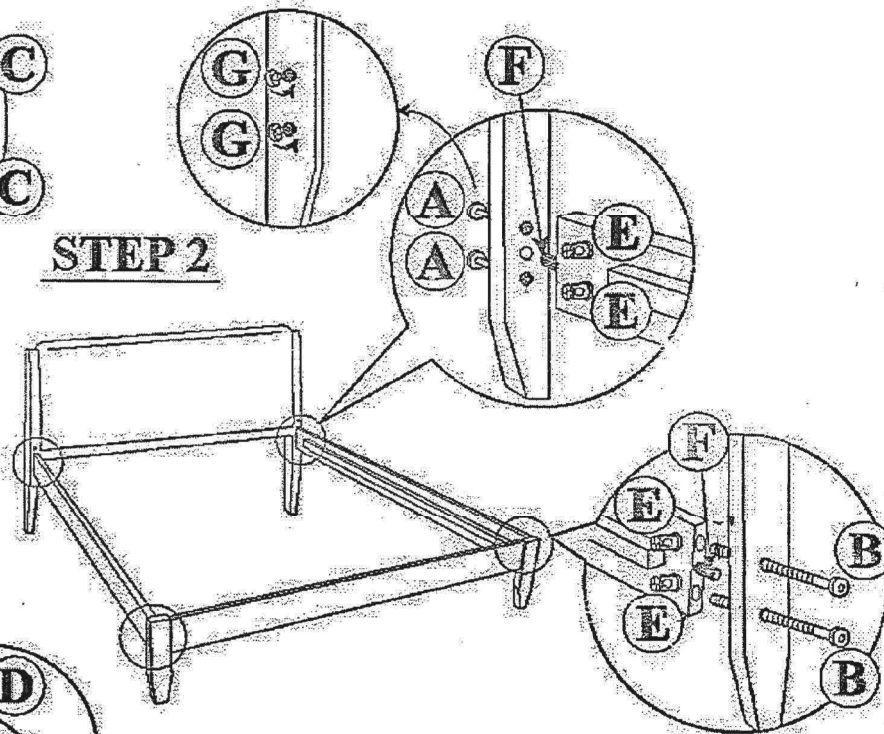

### STEP 3

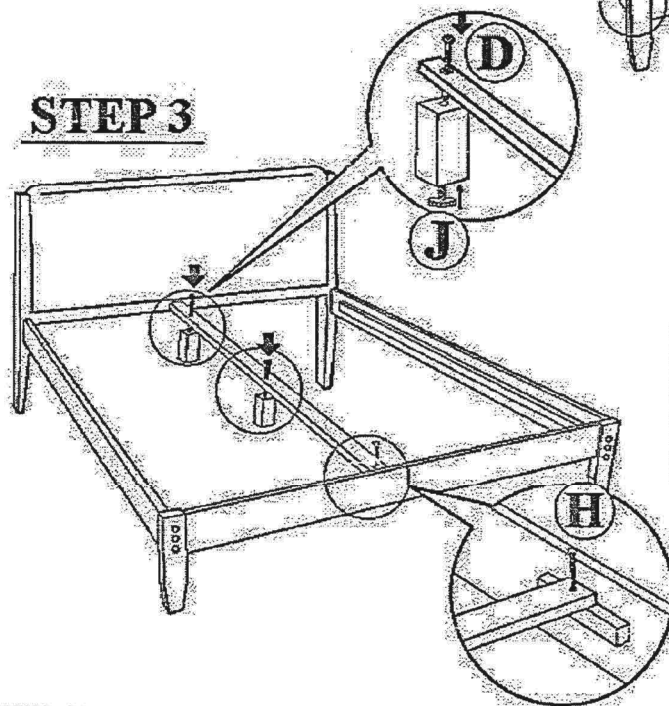

### STEP 4

