

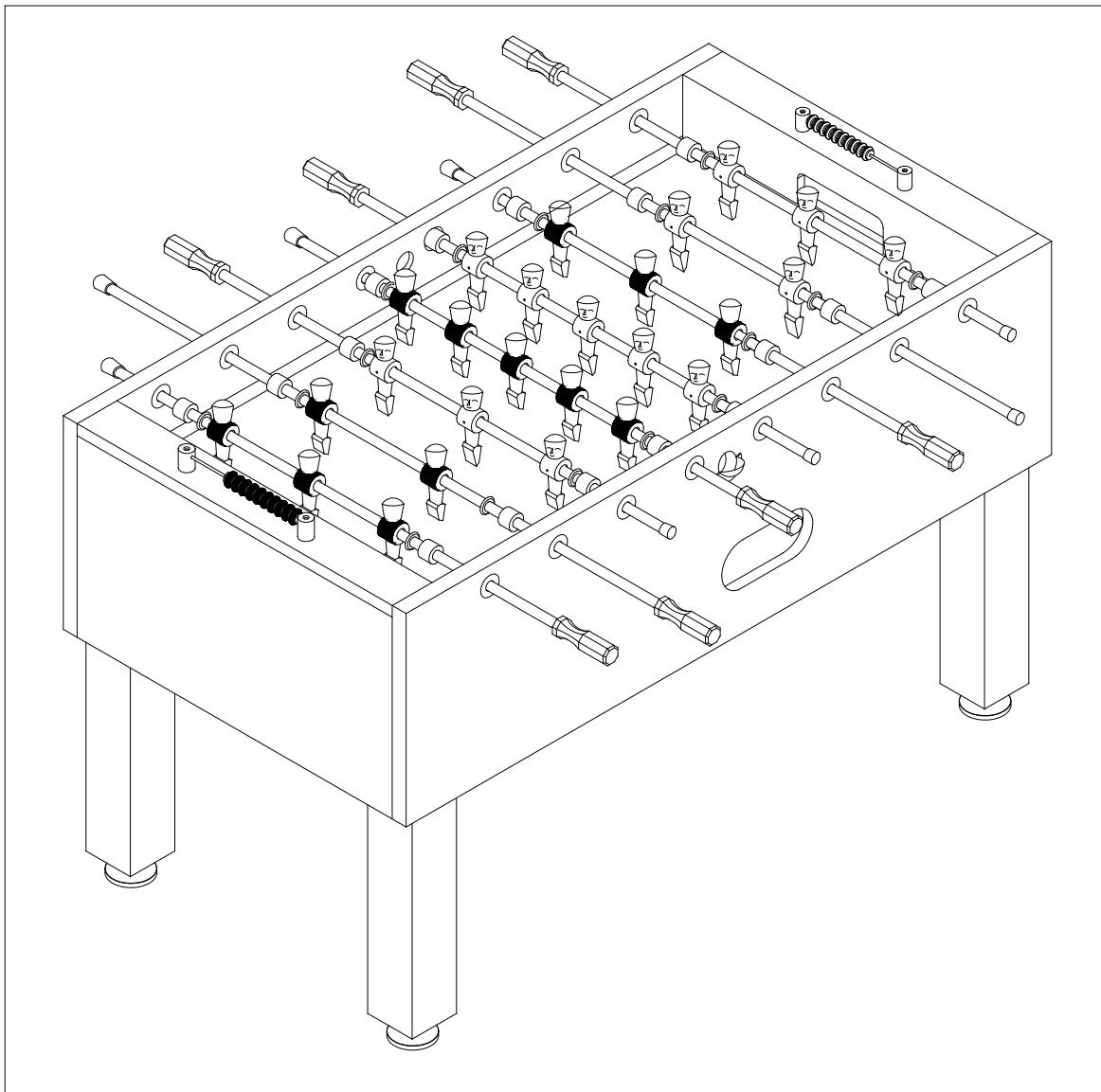

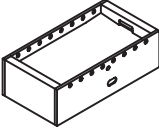

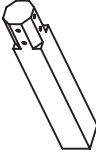

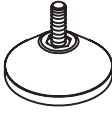

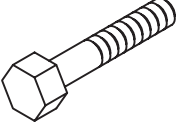



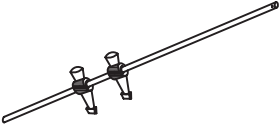
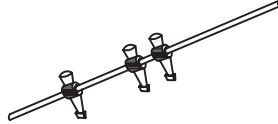
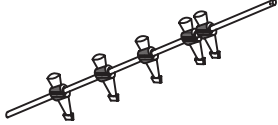
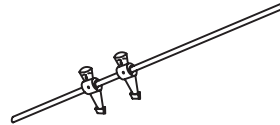
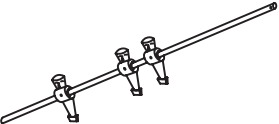
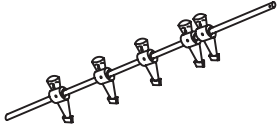



# Foosball Table

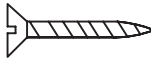

## Assembly Instructions

## Parts List

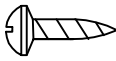
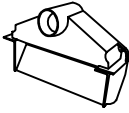
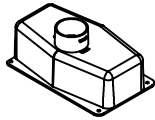
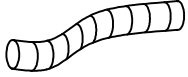
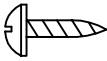
<p>#1</p>  <p>Main frame 1 piece</p>	<p>#2</p>  <p>Leg 4 pieces</p>	<p>#3</p>  <p>Leg leveler 4 pieces</p>	<p>#4</p>  <p>3/8"X5-1/2" Bolt 16 pieces</p>
<p>#5</p>  <p>3/8"X25mm Washer 16 pieces</p>	<p>#6</p>  <p>Side Ramp 2 pieces</p>	<p>#7</p>  <p>Left end Ramp 2 pieces</p>	<p>#8</p>  <p>Right end Ramp 2 pieces</p>
<p>#9</p>  <p>Home Player 2-man rod 1 piece</p>	<p>#10</p>  <p>Home Player 3-man rod 2 pieces</p>	<p>#11</p>  <p>Home Player 5-man rod 1 piece</p>	<p>#12</p>  <p>Visiting Player 2-man rod 1 piece</p>
<p>#13</p>  <p>Visiting Player 3-man rod 2 pieces</p>	<p>#14</p>  <p>Visiting Player 5-man rod 1 piece</p>	<p>#15</p>  <p>T5X15mm Bolt 8 pieces</p>	<p>#16</p>  <p>Handle 8 pieces</p>
<p>#17</p>  <p>Bumper 16 pieces</p>	<p>#18</p>  <p>5/8"X38mm Plastic washer 16 pieces</p>	<p>#19</p>  <p>Rod end cap 8 pieces</p>	<p>#20</p>  <p>Iron pin 10 pieces</p>
<p>#21</p>  <p>Scoring system 1 piece</p>	<p>#22</p>  <p>Scoring system 1 piece</p>	<p>#23</p>  <p>F4X2" Screw 4 pieces</p>	<p>#24</p>  <p>Ball entry cup 2 pieces</p>

<p>#25</p>  <p>8#X5/8" Phillips head Screw 6 pieces</p>	<p>#26</p>  <p>Plastic goal 2 pieces</p>	<p>#27</p>  <p>Plastic ball catcher 2 pieces</p>	<p>#28</p>  <p>Ball runner 2 pieces</p>
<p>#29</p>  <p>T4x1/2" Screw 12 pieces</p>	<p>#30</p>  <p>Soccer Ball 4 pieces</p>	<p>#31</p>  <p>Wrench 1 piece</p>	

Step 1:

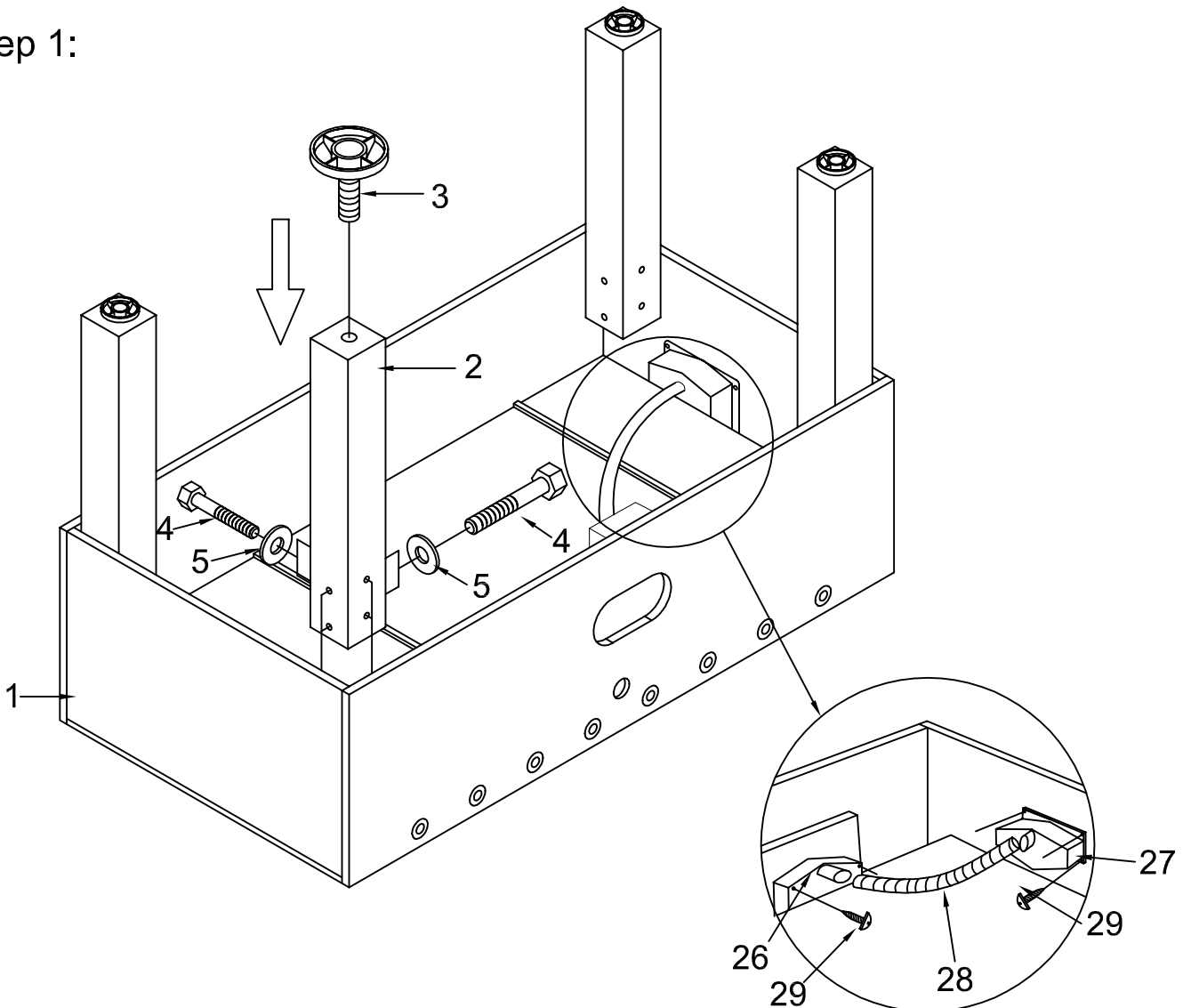

Step 2:

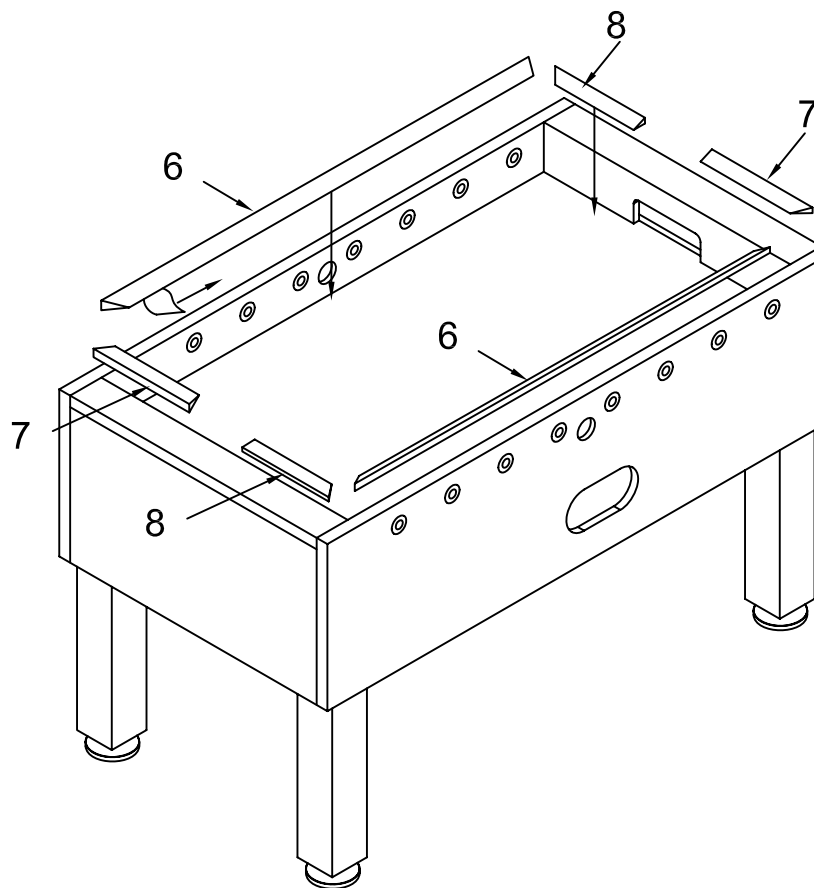

Step 3:

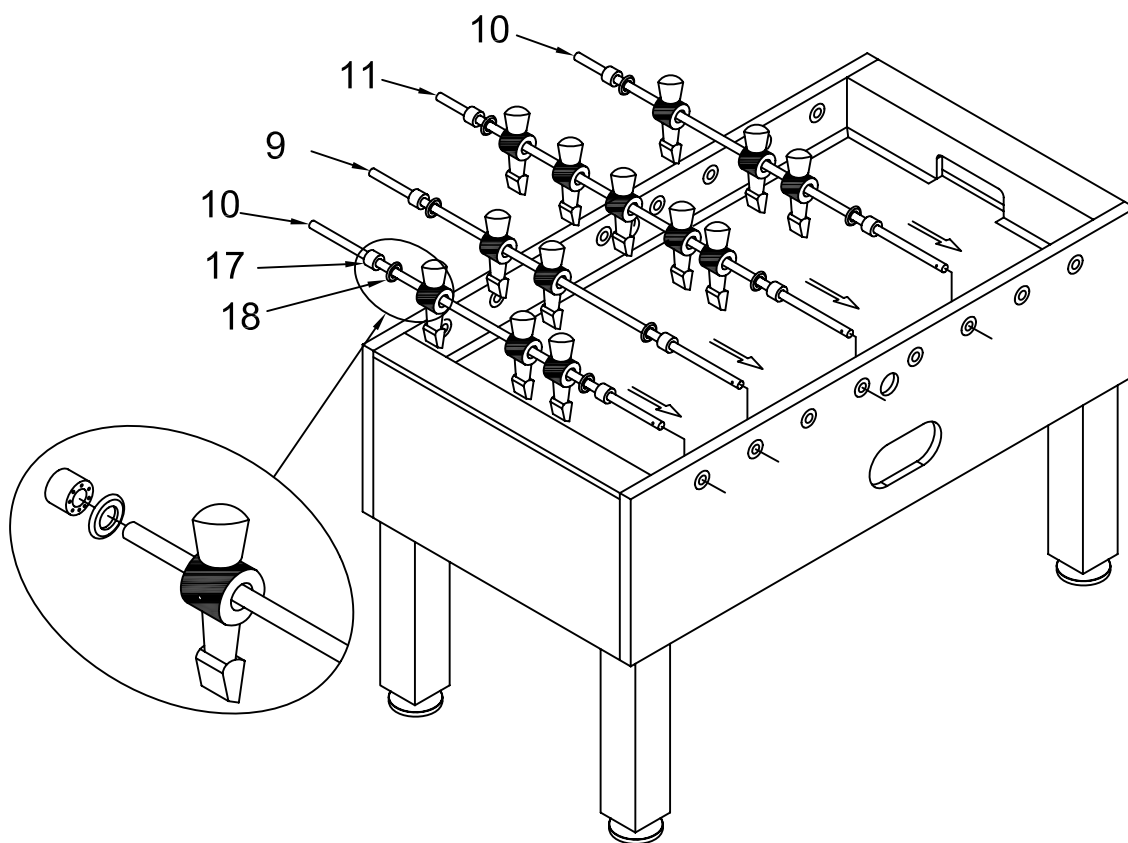

Step 4:

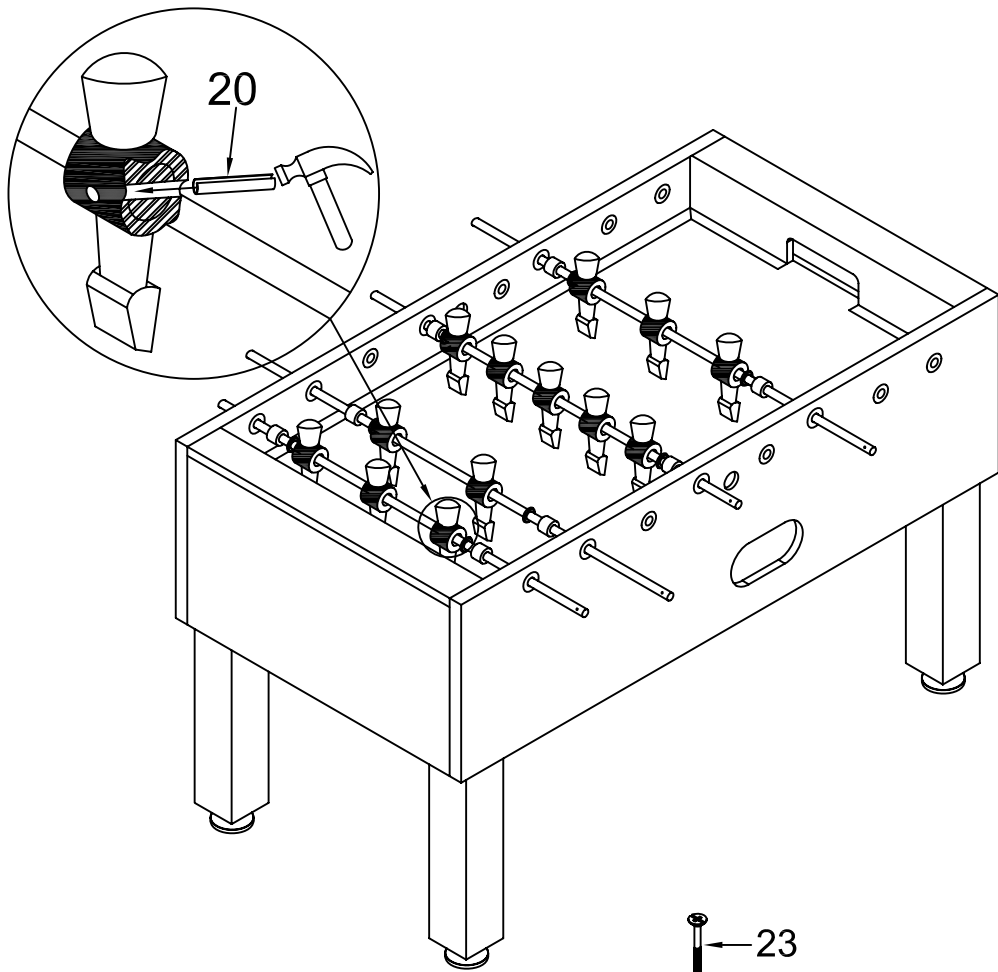

Step 5:

