

Top View

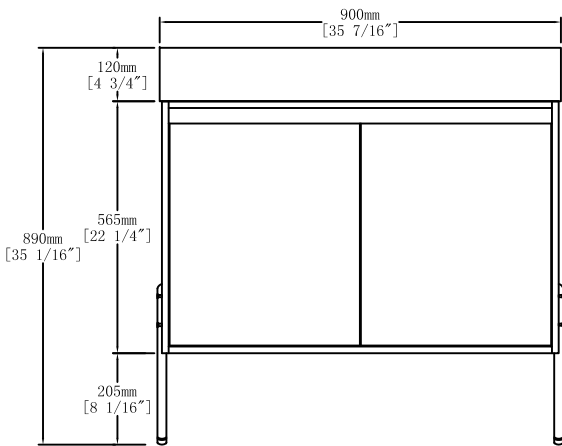

Front View

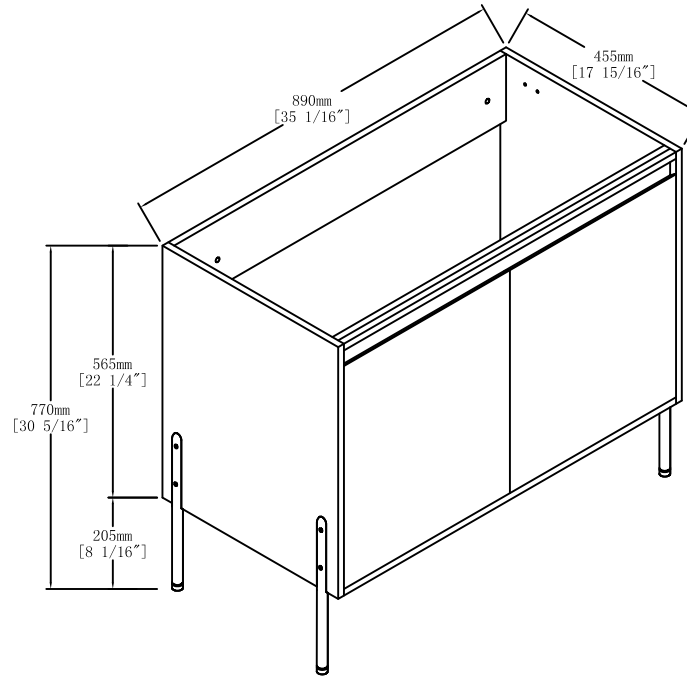
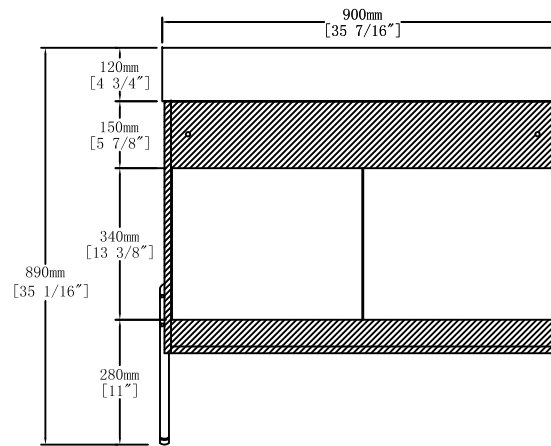

Back View

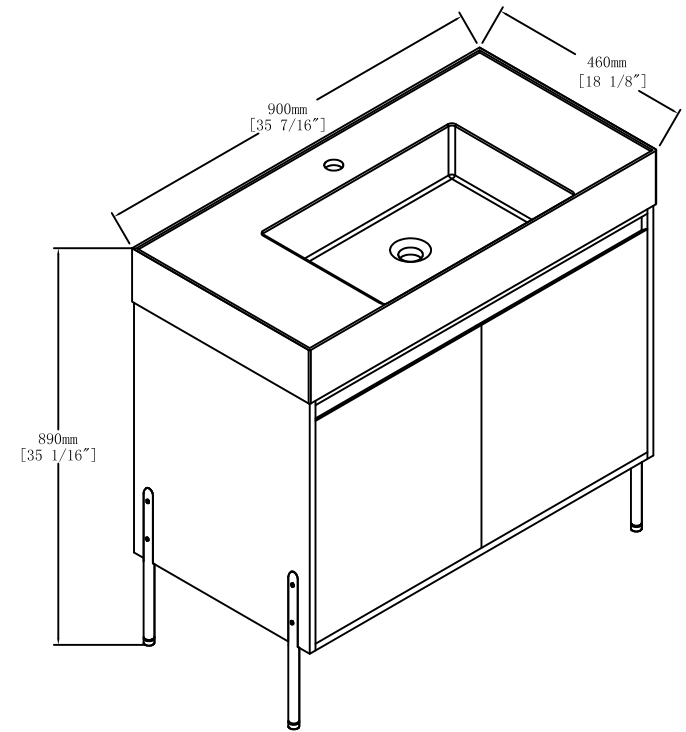

	Item NO.	LV C1136	Version	V1
	Project		Date	2024-4-23