

THANK YOU SO MUCH FOR PURCHASING OUR PRODUCT. IF YOU HAVE ANY TROUBLE PUTTING YOUR KIT TOGETHER OR MISSING PIECES PLEASE CONTACT US FOR ANY HELP AND RETURNS.

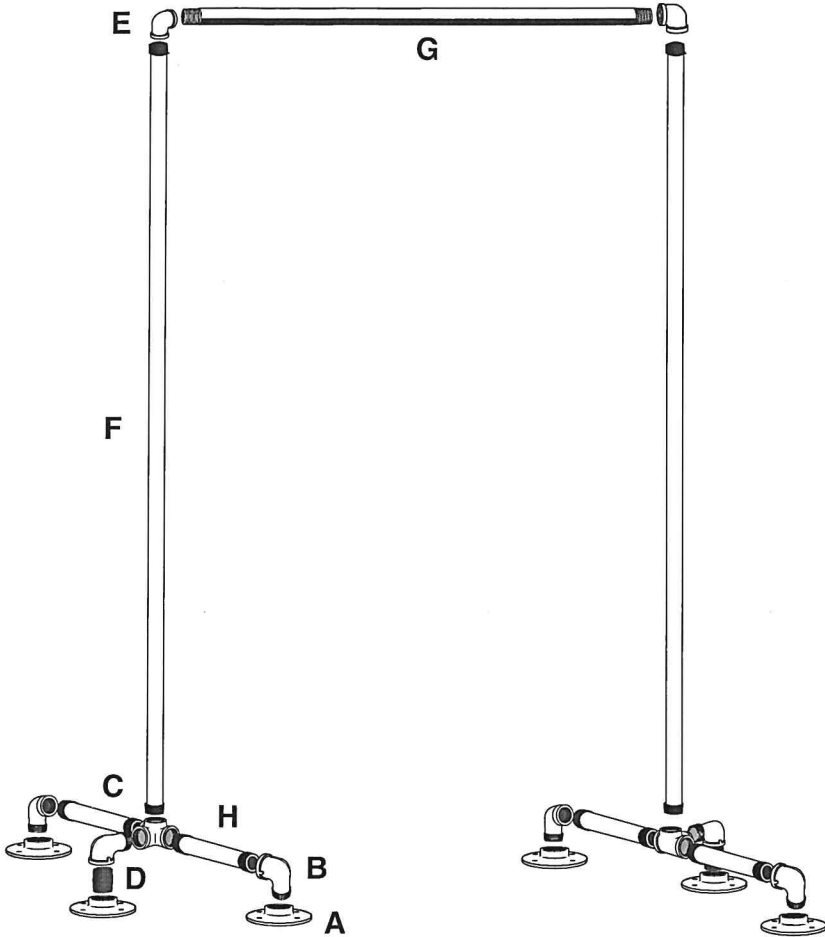

A - 6 X FLANGES

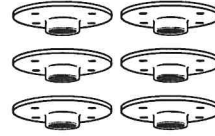

B - 6 X STREET ELBOW

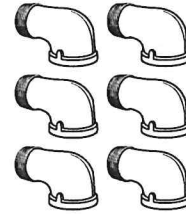

C - 2 X SIDE OUT TEE



D - 2 X CONNECTOR



E - 2 X ELBOW



F - 2 X 48" PIPE

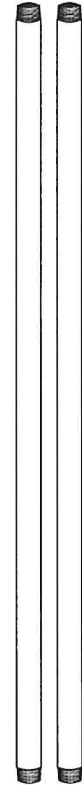

G - 1 X 36" PIPE



H - 4 X 8" PIPE



CLEAN AND SEAL THE PIPE BEFORE USE

This kit is made of industrial grade authentic pipe. This oil could rub off on your clothes. It is coated in oil post production to prevent rust. The kit should be cleaned and sealed to prevent rusting. See Clean and Seal sheet for more information. Use a cleaning wipe on the pipe, wait until dry and then spray with any semi-gloss polyurethane spray.

1. Connect E, F, and G into an L.
2. Connect the other F Pipe.
3. Assemble and connect each of the feet as shown.

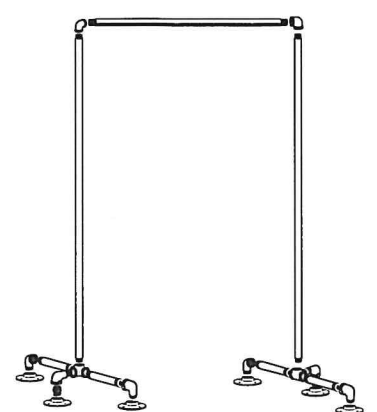
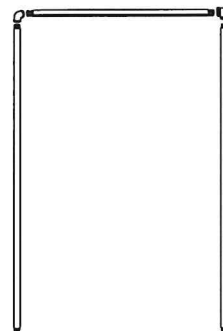
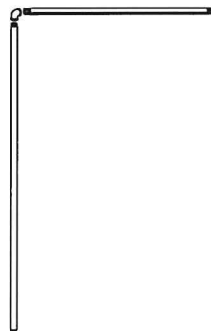

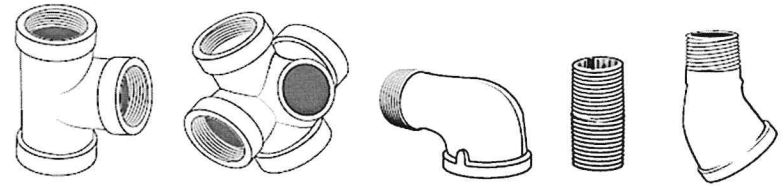

CLEAN AND SEAL

IMPORTANT: Pipe Décor industrial grade black pipes and fittings are coated with a rust preventive oil during manufacturing. You can use your kit as is or clean it before use. **BUT IF YOU CLEAN YOUR KIT YOU MUST SEAL IT TO PREVENT RUSTING.**

CLEAN

Recommended Supplies: Regular De-greasing Dish Soap and Wash Cloths. Gloves are optional.

1. In your kitchen sink or utility sink wash your pipe decor pieces with warm water and dish soap until the oil is removed. Rinse well after washing.
2. Wipe the pipe dry with a wash cloth and wait until **COMPLETELY DRY**. The pieces must be completely dry before sealing them.

SEAL

Recommended Supplies: Polyurethane Matte or Satin Finish Spray or Finishing Wax, Gloves and Wash or Lint-Free Cloths.

- 1A. Spray each dry pipe and fitting with a polyurethane matte or satin finish. Wait until dry to assemble kit.
- 1B. Coat each dry piece with a finishing wax. Wait 20 minutes then polish with a wash cloth by wiping them down. The faster wiping will result in a shinier finish.